



Graphit Group

www.graphitgroup.com

WORLDWIDE[®]



VERNICIATURA

MOD. _____
COD. _____

DESCRIZIONE/DESCRIPTION/BEZEICHNUNG/DESCRIPTION/DESCRIPCIÓN
DIMENSIONI/DIMENSIONS/ABMESSUNGEN/DIMENSIONS/DIMENSIONES

POTENZA/POWER/LEISTUNG/PUISSANCE/POTENCIA
VOLTAGGIO/VOLTAGE/SPANNUNG/VOLTAGE/VOLTAJE

⚡ kW
kcal/h

⚡ kw
V~
Hz

PREZZO/PRICE
PREIS/PRIX/PRECIO
KG / M³



RAL9005

SOVRAPPREZZO PORTA E PANNELLO COMANDI SERIE 60/70/90 VERNICIATI RAL9005 OPACO "NERO INTENSO"
EN EXTRA COST for door and control panel of 60/70/90 series painted RAL9005 opaque "JET BLACK"
cm.30÷40



248,00
/



RAL9005

RAL9016

SOVRAPPREZZO PORTA E PANNELLO COMANDI SERIE 60/70/90 VERNICIATI RAL9016 OPACO "BIANCO TRAFFICO"
EN EXTRA COST for door and control panel of 60/70/90 series painted RAL9016 opaque "TRAFFIC WHITE"
cm.30÷40



248,00
/

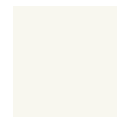

RAL9016

RAL7024

SOVRAPPREZZO PORTA E PANNELLO COMANDI SERIE 60/70/90 VERNICIATI RAL7024 OPACO "GRIGIO GRAFITE"
EN EXTRA COST for door and control panel of 60/70/90 series painted RAL7024 opaque "GRAPHITE GREY"
cm.30÷40



300,00
/



RAL7024

RAL3000

SOVRAPPREZZO PORTA E PANNELLO COMANDI SERIE 60/70/90 VERNICIATI RAL3000 OPACO "ROSSO FUOCO"
EN EXTRA COST for door and control panel of 60/70/90 series painted RAL3000 opaque "FLAME RED"
cm.30÷40



300,00
/



RAL3000

RAL2004

SOVRAPPREZZO PORTA E PANNELLO COMANDI SERIE 60/70/90 VERNICIATI RAL2004 OPACO "ARANCIO PURO"
EN EXTRA COST for door and control panel of 60/70/90 series painted RAL2004 opaque "PURE ORANGE"
cm.30÷40



300,00
/



RAL2004

RAL5015

SOVRAPPREZZO PORTA E PANNELLO COMANDI SERIE 60/70/90 VERNICIATI RAL5015 OPACO "BLU CIELO"
EN EXTRA COST for door and control panel of 60/70/90 series painted RAL5015 opaque "SKY BLUE"
cm.30÷40



300,00
/



RAL 5015

VERNICIATURA

MOD. _____
COD. _____

DESCRIZIONE/DESCRIPTION/BEZEICHNUNG/DESCRIPTION/DESCRIPCIÓN
DIMENSIONI/DIMENSIONS/ABMESSUNGEN/DIMENSIONS/DIMENSIONES

POTENZA/POWER/LEISTUNG/PUISSANCE/POTENCIA
VOLTAGGIO/VOLTAGE/SPANNUNG/VOLTAGE/VOLTAJE

⚡ kW kcal/h
⚡ kw V~ Hz

PREZZO/PRICE
PREIS/PRIX/PRECIO
KG / M³



RAL EXTRA SOVRAPPREZZO PORTA E PANNELLO COMANDI SERIE 60/70/90 VERNICIATI RAL A SCELTA FUORI LISTINO
EN EXTRA COST for door and control panel of 60/70/90 series painted RAL extra price list
cm.30÷40



342,00 /

RAL9005 TMA1 SOVRAPPREZZO TESTATA 1 LATO SERIE 60/70/90 VERNICIATA RAL9005 OPACO "NERO INTENSO"
EN EXTRA COST for lateral finish panel 1 side of 60/70/90 series painted RAL9005 opaque "JET BLACK"



300,00 /



RAL9005

RAL9016 TMA1 SOVRAPPREZZO TESTATA 1 LATO SERIE 60/70/90 VERNICIATA RAL9016 OPACO "BIANCO TRAFFICO"
EN EXTRA COST for lateral finish panel 1 side of 60/70/90 series painted RAL9016 opaque "TRAFFIC WHITE"



300,00 /

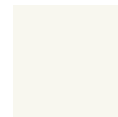

RAL9016

RAL7024 TMA1 SOVRAPPREZZO TESTATA 1 LATO SERIE 60/70/90 VERNICIATA RAL7024 OPACO "GRIGIO GRAFITE"
EN EXTRA COST for lateral finish panel 1 side of 60/70/90 series painted RAL7024 opaque "GRAPHITE GREY"



357,00 /



RAL7024

RAL3000 TMA1 SOVRAPPREZZO TESTATA 1 LATO SERIE 60/70/90 VERNICIATA RAL3000 OPACO "ROSSO FUOCO"
EN EXTRA COST for lateral finish panel 1 side of 60/70/90 series painted RAL3000 opaque "FLAME RED"



357,00 /



RAL3000

RAL2004 TMA1 SOVRAPPREZZO TESTATA 1 LATO SERIE 60/70/90 VERNICIATA RAL2004 OPACO "ARANCIO PURO"
EN EXTRA COST for lateral finish panel 1 side of 60/70/90 series painted RAL2004 opaque "PURE ORANGE"



357,00 /



RAL2004

VERNICIATURA

MOD. _____
COD. _____

DESCRIZIONE/DESCRIPTION/BEZEICHNUNG/DESCRIPTION/DESCRIPCIÓN
DIMENSIONI/DIMENSIONS/ABMESSUNGEN/DIMENSIONS/DIMENSIONES

POTENZA/POWER/LEISTUNG/PUISSANCE/POTENCIA
VOLTAGGIO/VOLTAGE/SPANNUNG/VOLTAGE/VOLTAJE

$\frac{kW}{kcal/h}$ $\frac{kW}{V \sim}$
Hz

PREZZO/PRICE
PREIS/PRIX/PRECIO
KG / M³



**RAL5015 TMA1 SOVRAPPREZZO TESTATA 1 LATO SERIE 60/70/90
VERNICIATA RAL5015 OPACO "BLU CIELO"**
EN EXTRA COST for lateral finish panel 1 side of 60/70/90 series
painted RAL5015 opaque "SKY BLUE"



357,00 /



RAL 5015

**RAL EXTRA TMA1 SOVRAPPREZZO TESTATA 1 LATO SERIE 60/70/90
VERNICIATA RAL A SCELTA FUORI LISTINO**
EN EXTRA COST for lateral finish panel 1 side of 60/70/90 series
painted RAL extra price list



398,00 /

**RAL9005 TMA2 SOVRAPPREZZO TESTATA 2 LATI SERIE 60/70/90
VERNICIATA RAL9005 OPACO "NERO INTENSO"**
EN EXTRA COST for lateral finish panel 2 sides of 60/70/90 series
painted RAL9005 opaque "JET BLACK"



533,00 /



RAL9005

**RAL9016 TMA2 SOVRAPPREZZO TESTATA 2 LATI SERIE 60/70/90
VERNICIATA RAL9016 OPACO "BIANCO TRAFFICO"**
EN EXTRA COST for lateral finish panel 2 sides of 60/70/90 series
painted RAL9016 opaque "TRAFFIC WHITE"



533,00 /

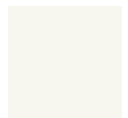

RAL9016

**RAL7024 TMA2 SOVRAPPREZZO TESTATA 2 LATI SERIE 60/70/90
VERNICIATA RAL7024 OPACO "GRIGIO GRAFITE"**
EN EXTRA COST for lateral finish panel 2 sides of 60/70/90 series
painted RAL7024 opaque "GRAPHITE GREY"



631,00 /



RAL7024

**RAL3000 TMA2 SOVRAPPREZZO TESTATA 2 LATI SERIE 60/70/90
VERNICIATA RAL3000 OPACO "ROSSO FUOCO"**
EN EXTRA COST for lateral finish panel 2 sides of 60/70/90 series
painted RAL3000 opaque "FLAME RED"



631,00 /



RAL3000

MOD. _____
COD. _____

DESCRIZIONE/DESCRIPTION/BEZEICHNUNG/DESCRIPTION/DESCRIPCIÓN
DIMENSIONI/DIMENSIONS/ABMESSUNGEN/DIMENSIONS/DIMENSIONES

POTENZA/POWER/LEISTUNG/PUISSANCE/POTENCIA
VOLTAGGIO/VOLTAGE/SPANNUNG/VOLTAGE/VOLTAJE

⚡ kW kcal/h
⚡ kw V~ Hz

PREZZO/PRICE
PREIS/PRIX/PRECIO
KG / M³



**RAL2004 TMA2 SOVRAPPREZZO TESTATA 2 LATI SERIE 60/70/90
VERNICIATA RAL2004 OPACO "ARANCIO PURO"**
EN EXTRA COST for lateral finish panel 2 sides of 60/70/90 series
painted RAL2004 opaque "PURE ORANGE"



631,00 /



RAL2004

**RAL5015 TMA2 SOVRAPPREZZO TESTATA 2 LATI SERIE 60/70/90
VERNICIATA RAL5015 OPACO "BLU CIELO"**
EN EXTRA COST for lateral finish panel 2 sides of 60/70/90 series
painted RAL5015 opaque "SKY BLUE"



631,00 /



RAL 5015

**RAL EXTRA TMA2 SOVRAPPREZZO TESTATA 2 LATI SERIE 60/70/90
VERNICIATA RAL A SCELTA FUORI LISTINO**
EN EXTRA COST for lateral finish panel 2 sides of 60/70/90 series
painted RAL extra price list



704,00 /

**RAL9005 SA SOVRAPPREZZO SCHIENA POSTERIORE A VISTA SERIE
60/70/90 VERNICIATA RAL9005 OPACO "NERO INTENSO"**
EN EXTRA COST for back cover of 60/70/90 series painted RAL9005
opaque "JET BLACK"
€/m



300,00 /



RAL9005

**RAL9016 SA SOVRAPPREZZO SCHIENA POSTERIORE A VISTA SERIE
60/70/90 VERNICIATA RAL9016 OPACO "BIANCO
TRAFFICO"**
EN EXTRA COST for back cover of 60/70/90 series painted RAL9016
opaque "TRAFFIC WHITE"
€/m



300,00 /

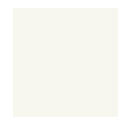

RAL9016

**RAL7024 SA SOVRAPPREZZO SCHIENA POSTERIORE A VISTA SERIE
60/70/90 VERNICIATA RAL7024 OPACO "GRIGIO GRAFITE"**
EN EXTRA COST for back cover of 60/70/90 series painted RAL7024
opaque "GRAPHITE GREY"
€/m



357,00 /



RAL7024

VERNICIATURA

MOD. _____
COD. _____

DESCRIZIONE/DESCRIPTION/BEZEICHNUNG/DESCRIPTION/DESCRIPCIÓN
DIMENSIONI/DIMENSIONS/ABMESSUNGEN/DIMENSIONS/DIMENSIONES

POTENZA/POWER/LEISTUNG/PUISSANCE/POTENCIA
VOLTAGGIO/VOLTAGE/SPANNUNG/VOLTAGE/VOLTAJE

$\frac{kW}{kcal/h}$ $\frac{kw}{V \sim}$
Hz

PREZZO/PRICE
PREIS/PRIX/PRECIO
KG / M³



**RAL3000 SA SOVRAPPREZZO SCHIENA POSTERIORE A VISTA SERIE
60/70/90 VERNICIATA RAL3000 OPACO "ROSSO FUOCO"**
EN EXTRA COST for back cover of 60/70/90 series painted RAL3000
opaque "FLAME RED"
€/m



357,00
/



RAL3000

**RAL2004 SA SOVRAPPREZZO SCHIENA POSTERIORE A VISTA SERIE
60/70/90 VERNICIATA RAL2004 OPACO "ARANCIO PURO"**
EN EXTRA COST for back cover of 60/70/90 series painted RAL2004
opaque "PURE ORANGE"
€/m



357,00
/



RAL2004

**RAL5015 SA SOVRAPPREZZO SCHIENA POSTERIORE A VISTA SERIE
60/70/90 VERNICIATA RAL5015 OPACO "BLU CIELO"**
EN EXTRA COST for back cover of 60/70/90 series painted RAL5015
opaque "SKY BLUE"
€/m



357,00
/



RAL 5015

**RAL EXTRA SA SOVRAPPREZZO SCHIENA POSTERIORE A VISTA SERIE
60/70/90 VERNICIATA RAL A SCELTA FUORI LISTINO**
EN EXTRA COST for back cover of 60/70/90 series painted RAL extra
price list
€/m



398,00
/

1985



PIANI LAVORO

MOD. _____
COD. _____

DESCRIZIONE/DESCRIPTION/BEZEICHNUNG/DESCRIPTION/DESCRIPCIÓN
DIMENSIONI/DIMENSIONS/ABMESSUNGEN/DIMENSIONS/DIMENSIONES

POTENZA/POWER/LEISTUNG/PUISSANCE/POTENCIA
VOLTAGGIO/VOLTAGE/SPANNUNG/VOLTAGE/VOLTAJE

⚡ kW _____
kcal/h _____
⚡ kw _____
V~ _____
Hz _____

PREZZO/PRICE
PREIS/PRIX/PRECIO
KG / M³



PL-1
05013000

PIANO LAVORO
EN Worktop • **DE** Arbeitsplatte • **FR** Plan de travail • **ES** Sobre de trabajo
cm. 30x 50x 29h



343,00
8 / 0,07

PL-2
05016000

cm. 60x 50x 29h

448,00
13 / 0,14

LA
05026000

LAVELLO VASCA CM 34X40X17H
EN Sink unit - Bowl cm 34x40x17h • **DE** Spülbecken - Becken cm 34x40x17h • **FR** Bac-évier - Bac cm 34x40x17h • **ES** Fregadero - Cuba cm 34x40x17h
cm. 60x 50x 29h

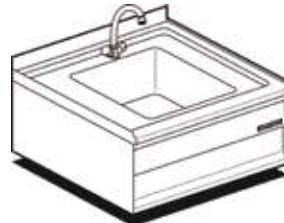

767,00
12 / 0,14

PC-1EM
05033010

PIANO COTTURA ELETTRICO 2 PIASTRE
EN Electric Cooking top nr.2 plates • **DE** Kochplatte elektrische - N. 2 Kochplatten • **FR** Rechaud électriques - N. 2 plaques • **ES** Sobre de cocción eléctrico N. 2 planchas
cm. 30x 50x 29h



⚡ 2,5 kW _____ **683,00**
230V~ _____ 11 / 0,07
50/60 Hz

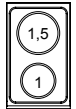

PC-2EM
05036010

PIANO COTTURA ELETTRICO 4 PIASTRE
EN Electric Cooking top nr.4 plates • **DE** Kochplatte elektrische - N. 4 Kochplatten • **FR** Rechaud électriques - N. 4 plaques • **ES** Sobre de cocción eléctrico N. 4 planchas
cm. 60x 50x 29h



⚡ 5 kW _____ **1.128,00**
230V~ _____ 17 / 0,14
50/60 Hz

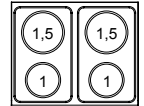

PC-2ET
05036030

cm. 60x 50x 29h

⚡ 5 kW _____ **1.144,00**
400V~3N _____ 17 / 0,14
230V~3 _____
50/60 Hz

RI-1EM
05043110

RISCALDANTE INFRAROSSO ELETTRICO
EN Electric Infrared heater • **DE** Infrarot-Strahler elektrische • **FR** Lampe chauffante a infra-rouge électriques • **ES** Calentador a infrarrojos eléctrico
cm. 29x 46x 37h



⚡ 0,32 kW _____ **456,00**
230V~ _____ 7 / 0,09
50/60 Hz

BS-1EM
05043010

CONTENITORE CALDO ELETTRICO VASCA GN 1/2 CM.15H CON FALSO FONDO FORATO
EN Electric Fry dump - Basin GN 1/2 15h with perforated double bottom • **DE** Frittenwanne elektrische - Becken GN 1/2 15h mit gelochtem Bodenrost • **FR** Silo a frites électriques - Cuve GN 1/2 15h avec double-fond perforé • **ES** Recipiente caliente eléctrico - Cuba GN 1/2 15h con falso fondo agujereado
cm. 30x 50x 29h



⚡ 0,83 kW _____ **760,00**
230V~ _____ 10 / 0,07
50/60 Hz

BAGNOMARIA ELETTRICI

MOD. _____
COD. _____

DESCRIZIONE/DESCRIPTION/BEZEICHNUNG/DESCRIPTION/DESCRIPCIÓN
DIMENSIONI/DIMENSIONS/ABMESSUNGEN/DIMENSIONS/DIMENSIONES

POTENZA/POWER/LEISTUNG/PUISSANCE/POTENCIA
VOLTAGGIO/VOLTAGE/SPANNUNG/VOLTAGE/VOLTAJE

⚡ kW _____
230V~
kcal/h _____
V~
Hz _____

PREZZO/PRICE
PREIS/PRIX/PRECIO
KG / M³



BM-1EM
05053010

BAGNOMARIA ELETTRICO VASCA PER GN 1/2 CM.15H

EN Electric Bain-marie - Bowl for GN 1/2 cm.15h • **DE** Wasserbad elektrische - Becken für GN 1/2 cm.15h • **FR** Bain-marie électriques - Cuve pour GN 1/2 cm.15h • **ES** Baño de maría eléctrico - Cuba para GN 1/2 cm.15h
cm. 30x 50x 29h



⚡ 0,83 kW _____ **752,00**
230V~ _____ 10 / 0,07
50/60 Hz _____

BM-2EM
05056010

BAGNOMARIA ELETTRICO VASCA PER GN 1/1 CM.15H

EN Electric Bain-marie - Bowl for GN 1/1 cm.15h • **DE** Wasserbad elektrische - Becken für GN 1/1 cm.15h • **FR** Bain-marie électriques - Cuve pour GN 1/1 cm.15h • **ES** Baño de maría eléctrico - Cuba para GN 1/1 cm.15h
cm. 60x 50x 29h



⚡ 1,66 kW _____ **998,00**
230V~ _____ 14 / 0,14
50/60 Hz _____

FTL-1EM
05063011

FRY-TOP ELETTRICO LISCIO, PIASTRA CM.27X41

EN Electric Fry-top smooth griddle, plate cm. 27x41 • **DE** Griddleplatte elektrische glatt, platte cm. 27x41 • **FR** Plaque électriques lisse, plaque cm. 27x41 • **ES** Fry-top eléctrico liso, plancha cm. 27x41
cm. 30x 50x 29h



⚡ 2,66 kW _____ **951,00**
230V~ _____ 23 / 0,15
50/60 Hz _____

FTL-1ET
05063031

cm. 30x 50x 29h

⚡ 3 kW _____ **1.075,00**
400V~3N _____ 23 / 0,15
230V~3 _____
50/60 Hz _____

FTL-1EMS
05063014

FRY-TOP ELETTRICO LISCIO CROMATO, PIASTRA CM.27X41

EN Electric Fry-top smooth chromed griddle, plate cm. 27x41 • **DE** Griddleplatte elektrische glatt hartverchromt, platte cm. 27x41 • **FR** Plaque électriques lisse chromée, plaque cm. 27x41 • **ES** Fry-top eléctrico liso cromado, plancha cm. 27x41
cm. 30x 50x 29h

⚡ 2,66 kW _____ **1.358,00**
230V~ _____ 23 / 0,15
50/60 Hz _____

FTL-1ETS
05063034

cm. 30x 50x 29h

⚡ 3 kW _____ **1.441,00**
400V~3N _____ 23 / 0,15
230V~3 _____
50/60 Hz _____

FTR-1EM
05063013

FRY-TOP ELETTRICO RIGATO, PIASTRA CM.27X41

EN Electric Fry-top grooved griddle, plate cm. 27x41 • **DE** Griddleplatte elektrische gerillt, platte cm. 27x41 • **FR** Plaque électriques nervurée, plaque cm. 27x41 • **ES** Fry-top eléctrico estriado, plancha cm. 27x41
cm. 30x 50x 29h

⚡ 2,66 kW _____ **1.144,00**
230V~ _____ 23 / 0,15
50/60 Hz _____

FTR-1ET
05063033

cm. 30x 50x 29h

⚡ 3 kW _____ **1.267,00**
400V~3N _____ 23 / 0,15
230V~3 _____
50/60 Hz _____

FRY-TOP ELETTRICI

MOD. _____
COD. _____

DESCRIZIONE/DESCRIPTION/BEZEICHNUNG/DESCRIPTION/DESCRIPCIÓN
DIMENSIONI/DIMENSIONS/ABMESSUNGEN/DIMENSIONS/DIMENSIONES

POTENZA/POWER/LEISTUNG/PUISSANCE/POTENCIA
VOLTAGGIO/VOLTAGE/SPANNUNG/VOLTAGE/VOLTAJE

⚡ kW kcal/h
⚡ kw V~ Hz

PREZZO/PRICE
PREIS/PRIX/PRECIO
KG / M³



FTL-2EM
05066011

FRY-TOP ELETTRICO LISCIO, PIASTRA CM.57X41
EN Electric Fry-top smooth griddle, plate cm. 57x41 • **DE** Griddleplatte elektrische glatt, platte cm. 57x41 • **FR** Plaque électriques lisse, plaque cm. 57x41 • **ES** Fry-top eléctrico liso, plancha cm. 57x41
cm. 60x 50x 29h



⚡ 5,32 kW 1.365,00
230V~ 40 / 0,28
50/60 Hz

FTL-2ET
05066031

cm. 60x 50x 29h

⚡ 6 kW 1.594,00
400V~3N 40 / 0,28
230V~3
50/60 Hz

FTL-2EMS
05066014

FRY-TOP ELETTRICO LISCIO CROMATO, PIASTRA CM.57X41
EN Electric Fry-top smooth chromed griddle, plate cm. 57x41 • **DE** Griddleplatte elektrische glatt hartverchromt, platte cm. 57x41 • **FR** Plaque électriques lisse chromée, plaque cm. 57x41 • **ES** Fry-top eléctrico liso cromado, plancha cm. 57x41
cm. 60x 50x 29h

⚡ 5,32 kW 1.903,00
230V~ 40 / 0,28
50/60 Hz

FTL-2ETS
05066034

cm. 60x 50x 29h

⚡ 6 kW 2.151,00
400V~3N 40 / 0,28
230V~3
50/60 Hz

FTLR-2EM
05066012

FRY-TOP ELETTRICO 1/2 LISCIO + 1/2 RIGATO, PIASTRA CM.57X41
EN Electric Fry-top 1/2 smooth + 1/2 grooved griddle, plate cm. 57x41
• **DE** Griddleplatte elektrische 1/2 glatt + 1/2 gerillt, platte cm. 57x41
• **FR** Plaque électriques 1/2 lisse + 1/2 nervurée, plaque cm. 57x41
• **ES** Fry-top eléctrico 1/2 liso + 1/2 estriado, plancha cm. 57x41
cm. 60x 50x 29h

⚡ 5,32 kW 1.566,00
230V~ 40 / 0,28
50/60 Hz

FTLR-2ET
05066032

cm. 60x 50x 29h

⚡ 6 kW 1.792,00
400V~3N 40 / 0,28
230V~3
50/60 Hz

FQ-1EM
05073010

FRIGGITRICE ELETTRICA - VASCA LT. 8 CESTO CM. 20X27X11H - PRODUZIONE PATATE: 9 KG/H
EN Electric fryer - Tank capacity lts. 8 Basket cm. 20x27x11h - Production: 9 Kg/hr • **DE** Friteuse elektrische - Beckeninhalte lt. 8 Korb cm. 20x27x11h - Pommes frites: 9 Kg/pro Stunde • **FR** Friteuse électrique - Cuve lt. 8 Panier cm. 20x27x11h - Production: 9 Kg/h • **ES** Freidora eléctrica - Cuba lt.8 Cesta cm. 20x27x11h - Producción patatas: 9 Kg/h
cm. 30x 50x 29h



⚡ 3 kW 1.022,00
230V~ 18 / 0,15
50/60 Hz

FQ-1ET
05073030

cm. 30x 50x 29h

⚡ 5,4 kW 1.236,00
400V~3N 20 / 0,15
230V~3
50/60 Hz

FQ-2EM
05076010

FRIGGITRICE ELETTRICA - VASCHE LT. 8+8 N. 2 CESTI CM. 20X27X11H - PRODUZIONE PATATE: 18 KG/H
EN Electric fryer - Tank capacity 8+8 lts. N. 2 Baskets cm. 20x27x11h - Production: 18 Kg/hr • **DE** Friteuse elektrische - Beckeninhalte lt. 8+8 - N. 2 Körbe cm. 20x27x11h - Pommes frites: 18 Kg/pro Stunde • **FR** Friteuse électrique - Cuve l. 8+8 N. 2 Paniers cm. 20x27x11h - Production: 18 Kg/h • **ES** Freidora eléctrica - Cuba lt. 8 + 8 2 Cestas cm. 20x27x11h - Producción patatas: 18 Kg/h
cm. 60x 50x 29h

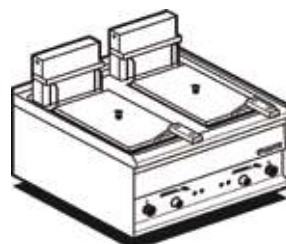

⚡ 6 kW 1.856,00
230V~ 33 / 0,28
50/60 Hz

FRIGGITRICI ELETTRICHE

MOD. _____
COD. _____

DESCRIZIONE/DESCRIPTION/BEZEICHNUNG/DESCRIPTION/DESCRIPCIÓN
DIMENSIONI/DIMENSIONS/ABMESSUNGEN/DIMENSIONS/DIMENSIONES

POTENZA/POWER/LEISTUNG/PUISSANCE/POTENCIA
VOLTAGGIO/VOLTAGE/SPANNUNG/VOLTAGE/VOLTAJE

⚡ kW _____
kcal/h _____
V~ _____
Hz _____

PREZZO/PRICE
PREIS/PRIX/PRECIO
KG / M³



FQ-2ET cm. 60x 50x 29h
05076030

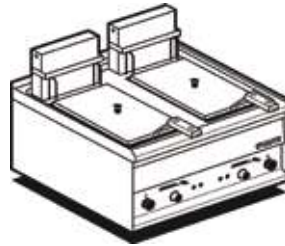

⚡ 10,8 kW _____ **2.261,00**
400V~3N _____ 35 / 0,28
230V~3 _____
50/60 Hz _____

531014400 OPTIONAL: CESTO 1/2
EN Optional: basket 1/2 • **DE** Zubehör: Fritierkorb 1/2 • **FR** En option: panier 1/2 • **ES** Opcional: cesta 1/2
cm. 10x 25x 10h



52,00
0.6 / 0,03

CP-1EM **CUOCI-PASTA/VERDURE ELETTRICO - VASCA LT. 10 - N. 4 CESTINI CM. 10X14X13,5H**
05083010
EN Electric Pastacooker - Tank capacity 10 lts. N. 4 baskets cm. 10x14x13,5h • **DE** Nudelkocher elektrische - Beckeninhalt lt. 10 N. 4 Körbe cm. 10x14x13,5h • **FR** Cuiser a pates/legumes électrique - Cuve l. 10 - N. 4 paniers cm. 10x14x13,5 • **ES** Cuece pastas/verduras eléctrico - Cuba lt. 10 - 4 cestas cm 10x14x13,5h
cm. 30x 50x 29h



⚡ 2,83 kW _____ **1.044,00**
230V~ _____ 13 / 0,07
50/60 Hz _____

CP-2ET **CUOCI-PASTA/VERDURE ELETTRICO - VASCA LT. 20 - N. 8 CESTINI CM. 10X14X13,5H**
05086030
EN Electric Pastacooker - Tank capacity 20 lts. - N 8 baskets cm. 10x14x13,5h • **DE** Nudelkocher elektrische - Beckeninhalt lt. 20 - N. 8 Körbe cm. 10x14x13,5h • **FR** Cuiser a pates/legumes électrique - Cuve l. 20 - N. 8 paniers cm. 10x14x13,5 • **ES** Cuece pastas/verduras eléctrico - Cuba lt. 20 - 8 cestas cm. 10x14x13,5h
cm. 60x 50x 29h

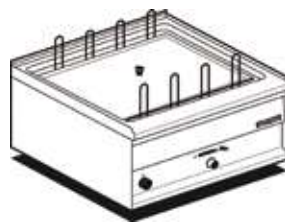

⚡ 6 kW _____ **1.609,00**
400V~3N _____ 22 / 0,14
230V~3 _____
50/60 Hz _____

531001600 CESTINO 1/4 INOX
EN Stainless steel basket 1/4 • **DE** Korb 1/4 aus Edelstahl • **FR** Panier inox 1/4 • **ES** Cesta 1/4 inox
cm. 10x 14x 13,5h



54,00
/ 0,02

531004000 CESTINO 1/2 INOX
EN Stainless steel basket 1/2 • **DE** Korb 1/2 aus Edelstahl • **FR** Panier inox 1/2 • **ES** Cesta 1/2 inox
cm. 10x 28x 13,5h



83,00
/ 0,03

531003900 CESTINO 1/1 INOX
EN Stainless steel basket 1/1 • **DE** Korb 1/1 aus Edelstahl • **FR** Panier inox 1/1 • **ES** Cesta 1/1 inox
cm. 20x 28x 13,5h



109,00
/ 0,04

MOBILI BASE

MOD. _____
COD. _____

DESCRIZIONE/DESCRIPTION/BEZEICHNUNG/DESCRIPTION/DESCRIPCIÓN
DIMENSIONI/DIMENSIONS/ABMESSUNGEN/DIMENSIONS/DIMENSIONES

POTENZA/POWER/LEISTUNG/PUISSANCE/POTENCIA
VOLTAGGIO/VOLTAGE/SPANNUNG/VOLTAGE/VOLTAJE

⚡ kW kcal/h
⚡ kW V~ Hz

PREZZO/PRICE
PREIS/PRIX/PRECIO
KG / M³



S-3
05210300
CAVALLETTO BASE
EN Stand • **DE** Untergestell • **FR** Piétement simple • **ES** Soporte base
cm. **30x 40x 60h**

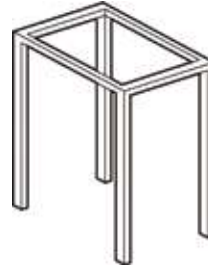

212,00
2 / 0,12

S-6
05210600
cm. **60x 40x 60h**

233,00
3 / 0,22

M-3
05220300
MOBILE BASE
EN Stand • **DE** Offener Unterbau • **FR** Placard ouvert • **ES** Mueble base
cm. **30x 40x 60h**

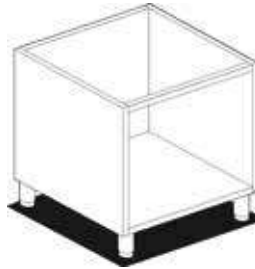

393,00
9 / 0,09

M-6
05220600
cm. **60x 40x 60h**

428,00
12 / 0,16

M-9
05220900
cm. **90x 40x 60h**

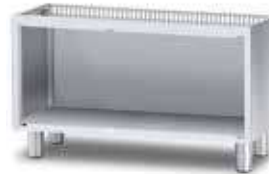

500,00
16 / 0,23

M-12
05221200
cm. **120x 40x 60h**

576,00
19 / 0,30

R-3
05240300
RIPIANO
EN Shelf • **DE** Abstellbrett • **FR** Etagère • **ES** Estante
cm. **26x 39,5x 3h**

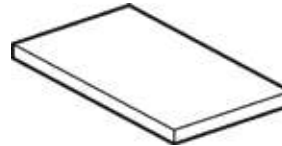

106,00
1 / 0,01

R-6
05240600
cm. **56x 39,5x 3h**

132,00
2 / 0,01

P-61
06256000
PORTA
EN Door • **DE** Flügeltür • **FR** Porte • **ES** Puerta
cm. **29,5x 2,5x 47h**



182,00
2.5 / 0,01

CG-5
05264800
COPRIGIUNTO
EN Joint cover • **DE** Klemmsteg • **FR** Couvre-joint • **ES** Cubre junta
cm. **48,5x 0,7x 1,5h**



30,00
0.1 / 1,00

TG-1
05270300
TAGLIERE
EN Chopping board • **DE** Schneidebrett • **FR** Plan à découpe • **ES** Picador
cm. **29x 48,5x 2,5h**

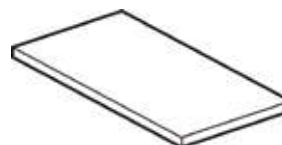

123,00
4 / 0,01

TG-2
05270600
cm. **59x 48,5x 2,5h**

217,00
8 / 0,01



CUCINE A GAS

MOD. _____
COD. _____

DESCRIZIONE/DESCRIPTION/BEZEICHNUNG/DESCRIPTION/DESCRIPCIÓN
DIMENSIONI/DIMENSIONS/ABMESSUNGEN/DIMENSIONS/DIMENSIONES

POTENZA/POWER/LEISTUNG/PUISSANCE/POTENCIA
VOLTAGGIO/VOLTAGE/SPANNUNG/VOLTAGE/VOLTAJE

⚡ kW _____
kcal/h _____
V~ _____
Hz _____

PREZZO/PRICE
PREIS/PRIX/PRECIO
KG / M³



CF2-58G
15120850

CUCINETTA 2 FUOCHI - FORNO GAS STATICO CON GRILL CM. 67X38X34H, TEMP: 50÷250°C, CON 1 GRIGLIA CM.65X36
EN Gas range - N. 2 burners Gas static oven with grill cm. 67x38x34h, temp: 50÷250°C, with 1 grid cm.65x36 • **DE** Gasherd - N. 2 Kochstellen Statischer Gas-Backofen mit Grill cm. 67x38x34h, temp: 50÷250°C, mit 1 Rost cm.65x36 • **FR** Cuisinière à gaz - N. 2 feux vifs Four gaz statique avec grill cm. 67x38x34h, temp: 50÷250°C, avec 1 grille cm.65x36 • **ES** Cocina a gas - N. 2 quemadores Horno gas estático con asador cm. 67x38x34h, temp: 50÷250°C, con 1 parrilla cm.65x36
cm. 80x 55x 90h



⚡ 21 kW _____ **3.269,00**
18.060 kcal/h 122 / 0,61

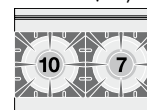

CF2-58GE
15130860

CUCINETTA 2 FUOCHI - FORNO ELETTRICO STATICO CON GRILL CM. 67X38X34H, TEMP: 50÷250°C, CON 1 GRIGLIA CM.65X36
EN Gas range - N. 2 burners Electric static oven with grill cm. 67x38x34h, temp: 50÷250°C, with 1 grid cm.65x36 • **DE** Gasherd - N. 2 Kochstellen - Statischer Elektro-Backofen mit Grill cm. 67x38x34h, temp: 50÷250°C, mit 1 Rost cm.65x36 • **FR** Cuisinière à gaz - N. 2 feux vifs - Four électrique statique avec grill cm. 67x38x34h, temp: 50÷250°C, avec 1 grille cm.65x36 • **ES** Cocina a gas - N. 2 quemadores - Horno eléctrico estático con asador cm. 67x38x34h, temp: 50÷250°C, con 1 parrilla cm.65x36
cm. 80x 55x 90h



⚡ 17 kW _____ **3.269,00**
14.620 kcal/h 120 / 0,61

⚡ 3,05 kW _____
230V~
50/60 Hz

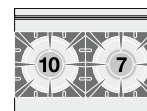

CF3-512GV
15121251

CUCINETTA 3 FUOCHI - FORNO GAS STATICO CON GRILL CM. 67X38X34H, TEMP: 50÷250°C, CON 1 GRIGLIA CM.65X36. VANO NEUTRO CON PORTA
EN Gas range - N. 3 burners - Gas static oven with grill cm. 67x38x34h, temp: 50÷250°C, with 1 grid cm.65x36 - Neutral cabinet with door • **DE** Gasherd - N. 3 Kochstellen - Statischer Gas-Backofen mit Grill cm. 67x38x34h, temp: 50÷250°C, mit 1 Rost cm.65x36 - Neutrales Schrankelement mit Tür • **FR** Cuisinière gaz - N. 3 feux vifs - Four gaz statique avec grill cm. 67x38x34h, temp: 50÷250°C, avec 1 grille cm.65x36 - Élément neutre avec porte • **ES** Cocina a gas - N. 3 quemadores - Horno gas estático con asador cm. 67x38x34h, temp: 50÷250°C, con 1 parrilla cm.65x36 - Armario neutro con puerta
cm. 120x 55x 90h



⚡ 31 kW _____ **4.074,00**
26.660 kcal/h 150 / 0,91

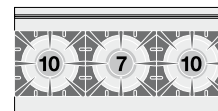

CF3-512GEV
15131261

CUCINETTA 3 FUOCHI - FORNO ELETTRICO STATICO CON GRILL CM. 67X38X34H, TEMP: 50÷250°C, CON 1 GRIGLIA CM.65X36. VANO NEUTRO CON PORTA
EN Gas range - N. 3 burners - Electric static oven with grill cm. 67x38x34h, temp: 50÷250°C, with 1 grid cm.65x36 - Neutral cabinet with door • **DE** Gasherd - N. 3 Kochstellen - Statischer Elektro-Backofen mit Grill cm. 67x38x34h, temp: 50÷250°C, mit 1 Rost cm.65x36 - Neutrales Schrankelement mit Tür • **FR** Cuisinière gaz - N. 3 feux vifs - Four électrique statique avec grill cm. 67x38x34h, temp: 50÷250°C, avec 1 grille cm.65x36 - Élément neutre avec porte • **ES** Cocina a gas - N. 3 quemadores - Horno eléctrico estático con asador cm. 67x38x34h, temp: 50÷250°C, con 1 parrilla cm.65x36 - Armario neutro con puerta
cm. 120x 55x 90h



⚡ 27 kW _____ **4.074,00**
23.220 kcal/h 148 / 0,91

⚡ 3,05 kW _____
230V~
50/60 Hz

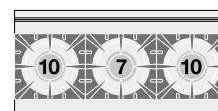

KIT-WOK
09580040

KIT WOK - FIAMMA VERTICALE - SOLO SU BRUCIATORE DA 10 KW E GRIGLIE IN GHISA
EN KIT WOK - vertical flame - only for 10 kW burner and cast iron grills • **DE** KIT WOK - vertikaler Flamme - nur 10 kW-Brenner und Roste aus Gusseisen • **FR** KIT WOK - verticale de la flamme - seulement 10 kW brûleur et grilles en fonte • **ES** KIT WOK - llama vertical - sólo 10 kW quemador y parrillas de hierro colado
cm. Ø 26x 16h



422,00
5 / 0,02



BAGNOMARIA ELETTRICI - TOP

MOD. _____
COD. _____

DESCRIZIONE/DESCRIPTION/BEZEICHNUNG/DESCRIPTION/DESCRIPCIÓN
DIMENSIONI/DIMENSIONS/ABMESSUNGEN/DIMENSIONS/DIMENSIONES

POTENZA/POWER/LEISTUNG/PUISSANCE/POTENCIA
VOLTAGGIO/VOLTAGE/SPANNUNG/VOLTAGE/VOLTAJE

⚡ kcal/h ⚡ kw
V~ Hz

PREZZO/PRICE
PREIS/PRIX/PRECIO
KG / M³



BMT-63EM **BAGNOMARIA ELETTRICO MONOFASE VASCA PER GN 1/2 + GN 1/4 H=15**

16050310

EN Bain marie singlephase Bowl for GN 1/2 + GN 1/4 h=15 • **DE** Wasserbäder einphasig Becken GN 1/2 + GN 1/4 h=15 • **FR** Bain marie monophasé Cuve GN 1/2 + GN 1/4 h=15 • **ES** Baño de maría monofásico Cuba para GN 1/2 + GN 1/4 h=15
cm. 30x 60x 28h



⚡ 1,55 kW **960,00**
230V~ 17 / 0,15
50/60 Hz

BMT-64EM **BAGNOMARIA ELETTRICO MONOFASE VASCA PER GN 1/2 + GN 1/3 H=15**

16050410

EN Bain marie singlephase Bowl for GN 1/2 + GN 1/3 h=15 • **DE** Wasserbäder einphasig Becken GN 1/2 + GN 1/3 h=15 • **FR** Bain marie monophasé Cuve GN 1/2 + GN 1/3 h=15 • **ES** Baño de maría monofásico Cuba para GN 1/2 + GN 1/3 h=15
cm. 40x 60x 28h

⚡ 1,65 kW **1.119,00**
230V~ 21 / 0,19
50/60 Hz

BMT-66EM **BAGNOMARIA ELETTRICO MONOFASE VASCA PER GN 1/1 + 2 GN 1/4 H=15**

16050610

EN Bain marie singlephase Bowl for GN 1/1 + 2 GN 1/4 h=15 • **DE** Wasserbäder einphasig Becken GN 1/1 + 2 GN 1/4 h=15 • **FR** Bain marie monophasé Cuve GN 1/1 + 2 GN 1/4 h=15 • **ES** Baño de maría monofásico Cuba para GN 1/1 + 2 GN 1/4 h=15
cm. 60x 60x 28h



⚡ 3,1 kW **1.239,00**
230V~ 23 / 0,28
50/60 Hz

BMT-64G **BAGNOMARIA A GAS VASCA PER GN 1/2 + GN 1/3 H=15**

16220450

EN Gas bain-marie Bowl for GN 1/2 + GN 1/3 h=15 • **DE** Gas Wasserbad Becken GN 1/2 + GN 1/3 h=15 • **FR** Bain-marie gaz Cuve pour GN 1/2 + GN 1/3 h=15 • **ES** Baño de maría gas Cuba para GN 1/2 + GN 1/3 h=15
cm. 40x 60x 28h

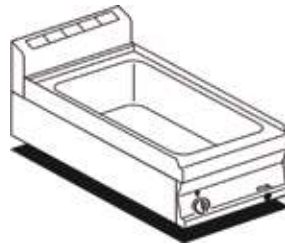

⚡ 2,5 kW **1.411,00**
2.150 kcal/h 26 / 0,19

BMT-66G **BAGNOMARIA A GAS VASCA PER GN 1/1 + 2 GN 1/4 H=15**

16220650

EN Gas bain-marie Bowl for GN 1/1 + 2 GN 1/4 h=15 • **DE** Gas Wasserbad Becken GN 1/1 + 2 GN 1/4 h=15 • **FR** Bain-marie gaz Cuve pour GN 1/1 + 2 GN 1/4 h=15 • **ES** Baño de maría gas Cuba para GN 1/1 + 2 GN 1/4 h=15
cm. 60x 60x 28h



⚡ 4,5 kW **1.708,00**
3.870 kcal/h 28 / 0,28

BST-64EM **CONTENITORE CALDO MONOFASE VASCA GN 2/3 H15 CON FALSO FONDO FORATO**

16040410

EN Fry dump singlephase Bowl GN 2/3 h15 with perforated bottom • **DE** Frittenwanne einphasig Becke GN 2/3 h15 mit gelochtem Bodenrost • **FR** Silo à frites monophasé Cuve GN 2/3 h15 avec double-fond perforé • **ES** Recipiente caliente monofásico Cuba GN 2/3 h15 con falso fondo agujereado
cm. 40x 60x 28h



⚡ 1,47 kW **1.302,00**
230V~ 22 / 0,19
50/60 Hz

BRF-64ET **BRASIERA FISSA MULTIFUNZIONALE ELETTRICA - Lt.12 VASCA CM. 30X42X10H**

06070433

EN Electric multi-function fixed braising pan - Lt.12 Bowl cm. 30x42x10h • **DE** Elektrische Multifunktionsbratpfanne Fest - Lt.12 Becken cm. 30x42x10h • **FR** Sauteuse fixe multifonction électrique - Lt. 12 Cuve cm. 30x42x10h • **ES** Sartén fija multifunción eléctrica Cuba - Lt.12 cm. 30x42x10h
cm. 40x 60x 90h



⚡ 3,3 kW **3.500,00**
400V~3N 75 / 0,37
230V~3
50/60 Hz

BRASIERE FISSE MULTIFUNZIONE A GAS

MOD. _____
COD. _____

DESCRIZIONE/DESCRIPTION/BEZEICHNUNG/DESCRIPTION/DESCRIPCIÓN
DIMENSIONI/DIMENSIONS/ABMESSUNGEN/DIMENSIONS/DIMENSIONES

POTENZA/POWER/LEISTUNG/PUISSANCE/POTENCIA
VOLTAGGIO/VOLTAGE/SPANNUNG/VOLTAGE/VOLTAJE

⚡ kW _____
kcal/h _____
V~ _____
Hz _____

PREZZO/PRICE
PREIS/PRIX/PRECIO
KG / M³



BRF-64G
06240453

BRASIERA FISSA MULTIFUNZIONALE GAS- LT.12 VASCA 30X42X10H

EN Gas multi-function fixed braising pan - Lt.12 Bowl 30x42x10h • **DE** Gas-Multifunktionsbratpfanne Fest - Lt.12 Becken 30x42x10h • **FR** Sauteuse fixe multifonction à gaz - Lt.12 Cuve 30x42x10h • **ES** Sartén fija multifunción a gas Cuba - Lt.12 30x42x10h
cm. 40x 60x 90h



⚡ 6 kW _____
5.160 kcal/h _____
3.560,00
75 / 0,37

BRT-66ET
16070630

BRASIERA TRIFASE - LT. 20 VASCA CM. 50,5X41X10H

EN Bratt-pan threephase - Tank capacity 20 lts. - Pan cm. 50,5x41x10 h • **DE** Bratpfanne dreiphasig - Lt. 20 - Becken cm. 50,5x41x10 h • **FR** Sauteuse triphase - Lt. 20 - Bac cm. 50,5x41x10h • **ES** Sartén trifásica - 20 lt. - Cuba cm. 50,5x41x10h
cm. 60x 60x 28h



⚡ 6 kW _____
400V~3N _____
230V~3 _____
50/60 Hz _____
1.812,00
45 / 0,28

BRF-66G
16240650

BRASIERA GAS - LT. 20 VASCA CM. 50,5X41X10H

EN Gas bratt-pan - Capacity 20 litres - Pan cm. 50,5x41x10 h • **DE** Gas Bratpfanne - Lt. 20 - Becken cm. 50,5x41x10 h • **FR** Sauteuse gaz - Lt. 20 - Bac cm. 50,5x41x10h • **ES** Sartén gas - 20 l. - Cuba cm. 50,5x41x10h
cm. 60x 60x 28h



⚡ 6,9 kW _____
5.930 kcal/h _____
2.308,00
46 / 0,28

CF4-68G
06680850

CUCINA A GAS 4 FUOCHI FORNO A GAS STATICO CON GRILL CM. 64X39X35H, TEMP: 125÷275°C, CON 1 GRIGLIA CM.53X32,5 GN1/1 - PORTA VETRO

EN Gas range - N. 4 burners - Gas static oven with grill cm. 64x39x35h, temp: 125÷275°C, with 1 grid cm.53x32,5 GN1/1 - glass door • **DE** Gasherd - N. 4 Kochstellen - Gas Statischer Backofen mit grill cm. 64x39x35h, temp: 125÷275°C, mit 1 Rost cm.53x32,5 GN1/1 - Glastür • **FR** Cuisinière gaz - N. 4 feux vifs - Four gaz statique avec grill cm. 64x39x35h, temp: 125÷275°C, avec 1 grille cm.53x32,5 GN1/1 - Porte vitrée • **ES** Cocina gas - N. 4 quemadores - Horno gas estático con asador cm. 64x39x35h, temp: 125÷275°C, con 1 parilla cm.53x32,5 GN1/1 - Puerta vidrio
cm. 80x 60x 90h



⚡ 22 kW _____
18.920 kcal/h _____
3.419,00
97 / 0,62

⚡ 0,015 kW _____
230V~ _____
50/60 Hz _____

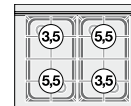

CF4-68G
06680851

CUCINA A GAS 4 FUOCHI FORNO A GAS STATICO CON GRILL CM. 64X39X35H, TEMP: 125÷275°C, CON 1 GRIGLIA CM.53X32,5 GN1/1 - PORTA CIECA INOX

EN Gas range - N. 4 burners - Gas static oven with grill cm. 64x39x35h, temp: 125÷275°C, with 1 grid cm.53x32,5 GN1/1 - Stainless steel door • **DE** Gasherd - N. 4 Kochstellen - Gas Statischer Backofen mit grill cm. 64x39x35h, temp: 125÷275°C, mit 1 Rost cm.53x32,5 GN1/1 - Edelstahltür/Porte acier inoxydable • **FR** Cuisinière gaz - N. 4 feux vifs - Four gaz statique avec grill cm. 64x39x35h, temp: 125÷275°C, avec 1 grille cm.53x32,5 GN1/1 - Porte acier inoxydable • **ES** Cocina gas - N. 4 quemadores - Horno gas estático con asador cm. 64x39x35h, temp: 125÷275°C, con 1 parilla cm.53x32,5 GN1/1 - Puerta ciega inox
cm. 80x 60x 90h



⚡ 22 kW _____
18.920 kcal/h _____
3.419,00
97 / 0,62

⚡ 0,015 kW _____
230V~ _____
50/60 Hz _____

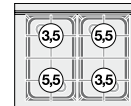

CF6-610G
06681050

CUCINA A GAS 6 FUOCHI FORNO A GAS STATICO CON GRILL CM. 64X39X35H, TEMP: 125÷275°C, CON 1 GRIGLIA CM.53X32,5 GN1/1 - PORTA VETRO

EN Gas range - N. 6 burners - Gas static oven with grill cm. 64x39x35h, temp: 125÷275°C, with 1 grid cm.53x32,5 GN1/1 - glass door • **DE** Gasherd - N. 6 Kochstellen - Gas statischer Backofen mit grill cm. 64x39x35h, temp: 125÷275°C, mit 1 Rost cm.53x32,5 GN1/1 - Glastür • **FR** Cuisinière gaz - N. 6 feux vifs - Four gaz statique avec grill cm. 64x39x35h, temp: 125÷275°C, avec 1 grille cm.53x32,5 GN1/1 - Porte vitrée • **ES** Cocina gas - N. 6 quemadores - Horno gas estático con asador cm. 64x39x35h, temp: 125÷275°C, con 1 parilla cm.53x32,5 GN1/1 - Puerta vidrio
cm. 100x 60x 90h



⚡ 31 kW _____
26.660 kcal/h _____
3.664,00
106 / 0,77

⚡ 0,015 kW _____
230V~ _____
50/60 Hz _____

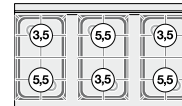

CUCINE A GAS

MOD. _____
COD. _____

DESCRIZIONE/DESCRIPTION/BEZEICHNUNG/DESCRIPTION/DESCRIPCIÓN
DIMENSIONI/DIMENSIONS/ABMESSUNGEN/DIMENSIONS/DIMENSIONES

POTENZA/POWER/LEISTUNG/PUISSANCE/POTENCIA
VOLTAGGIO/VOLTAGE/SPANNUNG/VOLTAGE/VOLTAJE

⚡ kW _____
kcal/h _____
V~ _____
Hz _____

PREZZO/PRICE
PREIS/PRIX/PRECIO
KG / M³



CF6-610G
06681051

CUCINA A GAS 6 FUOCHI FORNO A GAS STATICO CON GRILL CM. 64X39X35H, TEMP: 125÷275°C, CON 1 GRIGLIA CM.53X32,5 GN1/1 - PORTA CIECA INOX

EN Gas range - N. 6 burners - Gas static oven with grill cm. 64x39x35h, temp: 125÷275°C, with 1 grid cm.53x32,5 GN1/1 - Stainless steel door
• **DE** Gasherd - N. 6 Kochstellen - Gas statischer Backofen mit grill cm. 64x39x35h, temp: 125÷275°C, mit 1 Rost cm.53x32,5 GN1/1 - Edelstahltür/Porte acier inoxydable • **FR** Cuisinière gaz - N. 6 feux vifs - Four gaz statique avec grill cm. 64x39x35h, temp: 125÷275°C, avec 1 grille cm.53x32,5 GN1/1 - Porte acier inoxydable • **ES** Cocina gas - N. 6 quemadores - Horno gas estático con asador cm. 64x39x35h, temp: 125÷275°C, con 1 parilla cm.53x32,5 GN1/1 - Puerta ciega inox
cm. 100x 60x 90h



⚡ 31 kW _____
26.660 kcal/h _____ **3.664,00**
106 / 0,77

⚡ 0,015 kW _____
230V~ _____
50/60 Hz _____

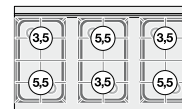

CF4-68GEM
06690860

CUCINA MISTA 4 FUOCHI CON FORNO ELETTRICO STATICO CON GRILL CM. 64X42X35H, TEMP: 50÷250°C, CON 1 GRIGLIA CM.53X32,5 GN1/1 - PORTA VETRO

EN Combined range static oven - N. 4 burners Static oven with grill cm. 64x42x35h, temp: 50÷250°C, with 1 grid cm.53x32,5 GN1/1 - Glass door
• **DE** Gemischtherd statischer Ofen - N. 4 Kochstellen Statischer Ofen mit Grill cm. 64x42x35h, temp: 50÷250°C, mit 1 Rost cm.53x32,5 GN1/1 - Glas­tür • **FR** Cuisinière mixte gaz four statique - N. 4 feux vifs Four statique avec grill cm. 64x42x35h, temp: 50÷250°C, avec 1 grille cm.53x32,5 GN1/1 - Porte vitrée • **ES** Cocina mixta horno estático - N. 4 quemadores Horno estático con asador cm. 64x42x35h, temp: 50÷250°C, con 1 parilla cm.53x32,5 GN1/1 - Puerta vidrio
cm. 80x 60x 90h



⚡ 18 kW _____
15.480 kcal/h _____ **3.055,00**
97 / 0,62

⚡ 2,62 kW _____
230V~ _____
50/60 Hz _____

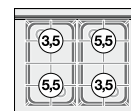

CF4-68GEM
06690861

CUCINA MISTA 4 FUOCHI CON FORNO ELETTRICO STATICO CON GRILL CM. 64X42X35H, TEMP: 50÷250°C, CON 1 GRIGLIA CM.53X32,5 GN1/1 - PORTA CIECA INOX

EN Combined range static oven - N. 4 burners Static oven with grill cm. 64x42x35h, temp: 50÷250°C, with 1 grid cm.53x32,5 GN1/1 - Stainless steel door
• **DE** Gemischtherd statischer Ofen - N. 4 Kochstellen Statischer Ofen mit Grill cm. 64x42x35h, temp: 50÷250°C, mit 1 Rost cm.53x32,5 GN1/1 - Edelstahl­tür • **FR** Cuisinière mixte gaz four estático - N. 4 feux vifs Four statique avec grill cm. 64x42x35h, temp: 50÷250°C, avec 1 grille cm.53x32,5 GN1/1 - Porte acier inoxydable • **ES** Cocina mixta horno estático - N. 4 quemadores Horno estático con asador cm. 64x42x35h, temp: 50÷250°C, con 1 parilla cm.53x32,5 GN1/1 - Puerta ciega inox
cm. 80x 60x 90h



⚡ 18 kW _____
15.480 kcal/h _____ **3.055,00**
97 / 0,62

⚡ 2,62 kW _____
230V~ _____
50/60 Hz _____

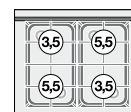

CF6-610GEM
06691060

CUCINA MISTA 6 FUOCHI CON FORNO ELETTRICO STATICO CON GRILL CM. 64X42X35H, TEMP: 50÷250°C, CON 1 GRIGLIA CM.53X32,5 GN1/1 - PORTA VETRO

EN Combined range static oven - N. 6 burners Static oven with grill cm. 64x42x35h, temp: 50÷250°C, with 1 grid cm.53x32,5 GN1/1 - Glass door
• **DE** Gemischtherd statischer Ofen - N. 6 Kochstellen Statischer Ofen mit Grill cm. 64x42x35h, temp: 50÷250°C, mit 1 Rost cm.53x32,5 GN1/1 - Glas­tür • **FR** Cuisinière mixte gaz four statique - N. 6 feux vifs Four statique avec grill cm. 64x42x35h, temp: 50÷250°C, avec 1 grille cm.53x32,5 GN1/1 - Porte vitrée • **ES** Cocina mixta horno estático - N. 6 quemadores Horno estático con asador cm. 64x42x35h, temp: 50÷250°C, con 1 parilla cm.53x32,5 GN1/1 - Puerta vidrio
cm. 100x 60x 90h



⚡ 27 kW _____
23.193 kcal/h _____ **3.590,00**
106 / 0,77

⚡ 2,62 kW _____
230V~ _____
50/60 Hz _____

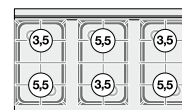

CF6-610GEM
06691061

CUCINA MISTA 6 FUOCHI CON FORNO ELETTRICO STATICO CON GRILL CM. 64X42X35H, TEMP: 50÷250°C, CON 1 GRIGLIA CM.53X32,5 GN1/1 - PORTA CIECA INOX

EN Combined range static oven - N. 6 burners Static oven with grill cm. 64x42x35h, temp: 50÷250°C, with 1 grid cm.53x32,5 GN1/1 - Stainless steel door
• **DE** Gemischtherd statischer Ofen - N. 6 Kochstellen Statischer Ofen mit Grill cm. 64x42x35h, temp: 50÷250°C, mit 1 Rost cm.53x32,5 GN1/1 - Edelstahl­tür • **FR** Cuisinière mixte gaz four estático - N. 6 feux vifs Four statique avec grill cm. 64x42x35h, temp: 50÷250°C, avec 1 grille cm.53x32,5 GN1/1 - Porte acier inoxydable • **ES** Cocina mixta horno estático - N. 6 quemadores Horno estático con asador cm. 64x42x35h, temp: 50÷250°C, con 1 parilla cm.53x32,5 GN1/1 - Puerta ciega inox
cm. 100x 60x 90h



⚡ 27 kW _____
23.193 kcal/h _____ **3.590,00**
106 / 0,77

⚡ 2,62 kW _____
230V~ _____
50/60 Hz _____

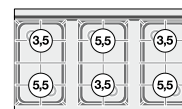

CUCINE ELETTRICHE

MOD. _____
COD. _____

DESCRIZIONE / DESCRIPTION / BEZEICHNUNG / DESCRIPTION / DESCRIPCIÓN
DIMENSIONI / DIMENSIONS / ABMESSUNGEN / DIMENSIONS / DIMENSIONES

POTENZA / POWER / LEISTUNG / PUISSANCE / POTENCIA
VOLTAGGIO / VOLTAGE / SPANNUNG / VOLTAGE / VOLTAJE

⚡ 9,05 kW
400V~3N
230V~3
230V~
50/60 Hz

PREZZO / PRICE
PREIS / PRIX / PRECIO
KG / M³



CFM4-66ET
06660632

**CUCINA ELETTRICA TRIFASE CON 4 PIASTRE FORNO
ELETRICO MULTIFUNZIONE CAMERA CM. 46X37X35H,
TEMP: 50÷250°C, CON 1 GRIGLIA CM.41X32,5 - PORTA
VETRO**

EN Range threephase - N. 4 plates Multifunction electric oven Chamber cm. 46x37x35h, temp: 50÷250°C, with 1 grid cm.41x32,5 - Glass door • **DE** Elektroherd dreiphasig - N. 4 Kochplatten Multifunktions-Elektroofen - cm. 46x37x35h, temp: 50÷250°C, mit 1 Rost cm.41x32,5 - Glastür • **FR** Cuisinière triphase - N. 4 plaques Four électrique à fonctions multiples - cm. 46x37x35h, temp: 50÷250°C, avec 1 grille cm.41x32,5 - Porte vitrée • **ES** Cocina trifásica - N. 4 planchas Horno eléctrico multifuncional - Cámara cm. 46x37x35h, temp: 50÷250°C, con 1 parilla cm.41x32,5 - Puerta vidrio
cm. 60x 60x 90h



⚡ 9,05 kW
400V~3N
230V~3
230V~
50/60 Hz

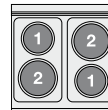

CFM4-66ET
06660633

**CUCINA ELETTRICA TRIFASE CON 4 PIASTRE FORNO
ELETRICO MULTIFUNZIONE CAMERA CM. 46X37X35H,
TEMP: 50÷250°C, CON 1 GRIGLIA CM.41X32,5 - PORTA
CIECA INOX**

EN Range threephase - N. 4 plates Multifunction electric oven Chamber cm. 46x37x35h, temp: 50÷250°C, with 1 grid cm.41x32,5 - Stainless steel door • **DE** Elektroherd dreiphasig - N. 4 Kochplatten Multifunktions-Elektroofen - cm. 46x37x35h, temp: 50÷250°C, mit 1 Rost cm.41x32,5 - Edelstahltür • **FR** Cuisinière triphase - N. 4 plaques Four électrique à fonctions multiples - cm. 46x37x35h, temp: 50÷250°C, avec 1 grille cm.41x32,5 - Porte acier inoxydable • **ES** Cocina trifásica - N. 4 planchas Horno eléctrico multifuncional - Cámara cm. 46x37x35h, temp: 50÷250°C, con 1 parilla cm.41x32,5 - Puerta ciega inox
cm. 60x 60x 90h



⚡ 9,05 kW
400V~3N
230V~3
230V~
50/60 Hz

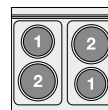

CFM4-68ET
06660832

**CUCINA ELETTRICA TRIFASE CON 4 PIASTRE FORNO
ELETRICO MULTIFUNZIONE CAMERA CM. 64X37X35H,
TEMP: 50÷250°C, CON 1 GRIGLIA CM.53X32,5 GN1/1 -
PORTA VETRO**

EN Range threephase - N. 4 plates Multifunction electric oven Chamber cm. 64x37x35h, temp: 50÷250°C, with 1 grid cm.53x32,5 GN1/1 - Glass door • **DE** Elektroherd dreiphasig - N. 4 Kochplatten Multifunktions-Elektroofen cm. 64x37x35h, temp: 50÷250°C, mit 1 Rost cm.53x32,5 GN1/1 - Glastür • **FR** Cuisinière triphase - N. 4 plaques Four électrique à fonctions multiples cm. 64x37x35h, temp: 50÷250°C, avec 1 grille cm.53x32,5 GN1/1 - Porte vitrée • **ES** Cocina trifásica - N. 4 planchas Horno eléctrico multifuncional - Cámara cm. 64x37x35h, temp: 50÷250°C, con 1 parilla cm.53x32,5 GN1/1 - Puerta vidrio
cm. 80x 60x 90h



⚡ 9,05 kW
400V~3N
230V~3
230V~
50/60 Hz

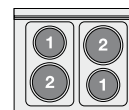

CFM4-68ET
06660833

**CUCINA ELETTRICA TRIFASE CON 4 PIASTRE FORNO
ELETRICO MULTIFUNZIONE CAMERA CM. 64X37X35H,
TEMP: 50÷250°C, CON 1 GRIGLIA CM.53X32,5 GN1/1 -
PORTA CIECA INOX**

EN Range threephase - N. 4 plates Multifunction electric oven Chamber cm. 64x37x35h, temp: 50÷250°C, with 1 grid cm.53x32,5 GN1/1 - Stainless steel door • **DE** Elektroherd dreiphasig - N. 4 Kochplatten Multifunktions-Elektroofen cm. 64x37x35h, temp: 50÷250°C, mit 1 Rost cm.53x32,5 GN1/1 - Edelstahltür • **FR** Cuisinière triphase - N. 4 plaques Four électrique à fonctions multiples cm. 64x37x35h, temp: 50÷250°C, avec 1 grille cm.53x32,5 GN1/1 - Porte acier inoxydable • **ES** Cocina trifásica - N. 4 planchas Horno eléctrico multifuncional - Cámara cm. 64x37x35h, temp: 50÷250°C, con 1 parilla cm.53x32,5 GN1/1 - Puerta ciega inox
cm. 80x 60x 90h



⚡ 9,05 kW
400V~3N
230V~3
230V~
50/60 Hz

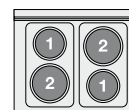

CUCINE ELETTRICHE

MOD. _____
COD. _____

DESCRIZIONE/DESCRIPTION/BEZEICHNUNG/DESCRIPTION/DESCRIPCIÓN
DIMENSIONI/DIMENSIONS/ABMESSUNGEN/DIMENSIONS/DIMENSIONES

POTENZA/POWER/LEISTUNG/PUISSANCE/POTENCIA
VOLTAGGIO/VOLTAGE/SPANNUNG/VOLTAGE/VOLTAJE

⚡ kW kcal/h
⚡ kW V~ Hz

PREZZO/PRICE
PREIS/PRIX/PRECIO
KG / M³



**CFM6-610ET CUCINA ELETTRICA TRIFASE CON 6 PIASTRE FORNO
ELETTRICO MULTIFUNZIONE CAMERA CM. 64X37X35H,
TEMP: 50÷250°C, CON 1 GRIGLIA CM.53X32,5 GN1/1 -
PORTA VETRO**

06661032

EN Range threephase - N. 6 plates Multifunction electric oven Chamber cm. 64x37x35h, temp: 50÷250°C, with 1 grid cm.53x32,5 GN1/1 - Glass door • DE Elektroherd dreiphasig - N. 6 Kochplatten Multifunktions-Elektroofen cm. 64x37x35h, temp: 50÷250°C, mit 1 Rost cm.53x32,5 GN1/1 - Glastür • FR Cuisinière triphase - N. 6 plaques Four électrique à fonctions multiples cm. 64x37x35h, temp: 50÷250°C, avec 1 grille cm.53x32,5 GN1/1 - Porte vitrée • ES Cocina trifásica - N. 6 planchas Horno eléctrico multifuncional - Cámara cm. 64x37x35h, temp: 50÷250°C, con 1 parilla cm.53x32,5 GN1/1 - Puerta vidrio
cm. 100x 60x 90h



⚡ 12,05 kW **4.292,00**
400V~3N 96 / 0,77
230V~3
50/60 Hz

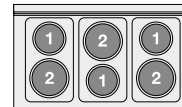

**CFM6-610ET CUCINA ELETTRICA TRIFASE CON 6 PIASTRE FORNO
ELETTRICO MULTIFUNZIONE CAMERA CM. 64X37X35H,
TEMP: 50÷250°C, CON 1 GRIGLIA CM.53X32,5 GN1/1 -
PORTA CIECA INOX**

06661033

EN Range threephase - N. 6 plates Multifunction electric oven Chamber cm. 64x37x35h, temp: 50÷250°C, with 1 grid cm.53x32,5 GN1/1 - Stainless steel door • DE Elektroherd dreiphasig - N. 6 Kochplatten Multifunktions-Elektroofen cm. 64x37x35h, temp: 50÷250°C, mit 1 Rost cm.53x32,5 GN1/1 - Edelstahltür • FR Cuisinière triphase - N. 6 plaques Four électrique à fonctions multiples cm. 64x37x35h, temp: 50÷250°C, avec 1 grille cm.53x32,5 GN1/1 - Porte acier inoxydabler • ES Cocina trifásica - N. 6 planchas Horno eléctrico multifuncional - Cámara cm. 64x37x35h, temp: 50÷250°C, con 1 parilla cm.53x32,5 GN1/1 - Puerta ciega inox
cm. 100x 60x 90h

⚡ 12,05 kW **4.292,00**
400V~3N 96 / 0,77
230V~3
50/60 Hz

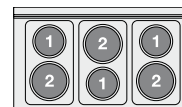

**CF4-68ET CUCINA ELETTRICA TRIFASE CON N. 4 PIASTRE - FORNO
ELETTRICO STATICO CON GRILL CM. 64X42X35H, TEMP:
50÷250°C, CON 1 GRIGLIA CM.53X32,5 GN1/1 - PORTA
VETRO**

06660830

EN Range threephase - N. 4 plates - Static oven with grill cm. 64x42x35h, temp: 50÷250°C, with 1 grid cm.53x32,5 GN1/1 - Glass door • DE Elektroherd dreiphasig - N. 4 Kochplatten Statischer Ofen mit Grill cm. 64x42x35h, temp: 50÷250°C, mit 1 Rost cm.53x32,5 GN1/1 - Glastür • FR Cuisinière triphase - N. 4 plaques - Four statique avec grill cm. 64x42x35h, temp: 50÷250°C, avec 1 grille cm.53x32,5 GN1/1 - Porte vitrée • ES Cocina trifásica - N. 4 planchas - Horno estático con asador cm. 64x42x35h, temp: 50÷250°C, con 1 parilla cm.53x32,5 GN1/1 - Puerta vidrio
cm. 80x 60x 90h



⚡ 8,62 kW **2.736,00**
400V~3N 91 / 0,62
230V~3
230V~
50/60 Hz

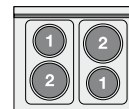

**CF4-68ET CUCINA ELETTRICA TRIFASE CON N. 4 PIASTRE - FORNO
ELETTRICO STATICO CON GRILL CM. 64X42X35H, TEMP:
50÷250°C, CON 1 GRIGLIA CM.53X32,5 GN1/1 - PORTA
CIECA INOX**

06660831

EN Range threephase - N. 4 plates - Static oven with grill cm. 64x42x35h, temp: 50÷250°C, with 1 grid cm.53x32,5 GN1/1 - Stainless steel door • DE Elektroherd dreiphasig - N. 4 Kochplatten Statischer Ofen mit Grill cm. 64x42x35h, temp: 50÷250°C, mit 1 Rost cm.53x32,5 GN1/1 - Edelstahltür • FR Cuisinière triphase - N. 4 plaques - Four statique avec grill cm. 64x42x35h, temp: 50÷250°C, avec 1 grille cm.53x32,5 GN1/1 - Porte acier inoxydable • ES Cocina trifásica - N. 4 planchas - Horno estático con asador cm. 64x42x35h, temp: 50÷250°C, con 1 parilla cm.53x32,5 GN1/1 - Puerta ciega inox
cm. 80x 60x 90h



⚡ 8,62 kW **2.736,00**
400V~3N 91 / 0,62
230V~3
230V~
50/60 Hz



CUCINE ELETTRICHE

MOD. _____
COD. _____

DESCRIZIONE/DESCRIPTION/BEZEICHNUNG/DESCRIPTION/DESCRIPCIÓN
DIMENSIONI/DIMENSIONS/ABMESSUNGEN/DIMENSIONS/DIMENSIONES

POTENZA/POWER/LEISTUNG/PUISSANCE/POTENCIA
VOLTAGGIO/VOLTAGE/SPANNUNG/VOLTAGE/VOLTAJE

⚡ kW _____
kcal/h _____
V~ _____
Hz _____

PREZZO/PRICE
PREIS/PRIX/PRECIO
KG / M³



CF6-610ET
06661030

CUCINA ELETTRICA TRIFASE CON N. 6 PIASTRE - FORNO ELETTRICO STATICO CON GRILL CM. 64X42X35H, TEMP: 50÷250°C, CON 1 GRIGLIA CM.53X32,5 GN1/1 - PORTA VETRO
EN Range threephase - N. 6 plates - Static oven with grill cm. 64x42x35h, temp: 50÷250°C, with 1 grid cm.53x32,5 GN1/1 - Glass door • DE Elektroherd dreiphasig - N. 6 Kochplatten Statischer Ofen mit Grill cm. 64x42x35h, temp: 50÷250°C, mit 1 Rost cm.53x32,5 GN1/1 - Glasstür • FR Cuisinière triphase - N. 6 plaques - Four statique avec grill cm. 64x42x35h, temp: 50÷250°C, avec 1 grille cm.53x32,5 GN1/1 - Porte vitrée • ES Cocina trifásica - N. 6 planchas - Horno estático con asador cm. 64x42x35h, temp: 50÷250°C, con 1 parilla cm.53x32,5 GN1/1 - Puerta vidrio
cm. 100x 60x 90h



⚡ 11,62 kW _____ **3.164,00**
400V~3N _____ 95 / 0,77
230V~3 _____
50/60 Hz _____



CF6-610ET
06661031

CUCINA ELETTRICA TRIFASE CON N. 6 PIASTRE - FORNO ELETTRICO STATICO CON GRILL CM. 64X42X35H, TEMP: 50÷250°C, CON 1 GRIGLIA CM.53X32,5 GN1/1 - PORTA CIECA INOX
EN Range threephase - N. 6 plates - Static oven with grill cm. 64x42x35h, temp: 50÷250°C, with 1 grid cm.53x32,5 GN1/1 - Stainless steel door • DE Elektroherd dreiphasig - N. 6 Kochplatten Statischer Ofen mit Grill cm. 64x42x35h, temp: 50÷250°C, mit 1 Rost cm.53x32,5 GN1/1 - Edelstahltür • FR Cuisinière triphase - N. 6 plaques - Four statique avec grill cm. 64x42x35h, temp: 50÷250°C, avec 1 grille cm.53x32,5 GN1/1 - Porte acier inoxydable • ES Cocina trifásica - N. 6 planchas - Horno estático con asador cm. 64x42x35h, temp: 50÷250°C, con 1 parilla cm.53x32,5 GN1/1 - Puerta ciega inox
cm. 100x 60x 90h

⚡ 11,62 kW _____ **3.164,00**
400V~3N _____ 95 / 0,77
230V~3 _____
50/60 Hz _____

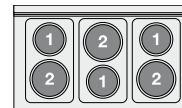

CFM4-66GEM
06690662

CUCINA MISTA 4 FUOCHI CON FORNO ELETTRICO MULTIFUNZIONE - CAMERA CM. 46X37X35H, TEMP: 50÷250°C, CON 1 GRIGLIA CM.41X32,5 - PORTA VETRO
EN Combined range - N. 4 burners Multifunction oven - Chamber cm. 46x37x35h, temp: 50÷250°C, with 1 grid cm.41x32,5 - Glass door • DE Gemischtherd - N. 4 Kochstellen Multifunktions-Ofen - cm. 46x37x35h, temp: 50÷250°C, mit 1 Rost cm.41x32,5 - Glasstür • FR Cuisinière mixte - N. 4 feux vifs Four à fonctions multiples - cm. 46x37x35h, temp: 50÷250°C, avec 1 grille cm.41x32,5 - Porte vitrée • ES Cocina mixta - N. 4 quemadores Horno multifuncional - Cámara cm. 46x37x35h, temp: 50÷250°C, con 1 parilla cm.41x32,5 - Puerta vidrio
cm. 60x 60x 90h



⚡ 18 kW _____ **3.440,00**
15.480 kcal/h _____ 70 / 0,47

⚡ 3,05 kW _____
230V~ _____
50/60 Hz _____

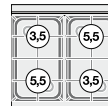

CFM4-66GEM
06690663

CUCINA MISTA 4 FUOCHI CON FORNO ELETTRICO MULTIFUNZIONE - CAMERA CM. 46X37X35H, TEMP: 50÷250°C, CON 1 GRIGLIA CM.41X32,5 - PORTA CIECA INOX
EN Combined range - N. 4 burners Multifunction oven - Chamber cm. 46x37x35h, temp: 50÷250°C, with 1 grid cm.41x32,5 - Stainless steel door • DE Gemischtherd - N. 4 Kochstellen Multifunktions-Ofen - cm. 46x37x35h, temp: 50÷250°C, mit 1 Rost cm.41x32,5 - Edelstahltür • FR Cuisinière mixte - N. 4 feux vifs Four à fonctions multiples - cm. 46x37x35h, temp: 50÷250°C, avec 1 grille cm.41x32,5 - Porte acier inoxydable • ES Cocina mixta - N. 4 quemadores Horno multifuncional - Cámara cm. 46x37x35h, temp: 50÷250°C, con 1 parilla cm.41x32,5 - Puerta ciega inox
cm. 60x 60x 90h



⚡ 18 kW _____ **3.440,00**
15.480 kcal/h _____ 70 / 0,47

⚡ 3,05 kW _____
230V~ _____
50/60 Hz _____

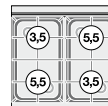

CFM4-68GEM
06690862

CUCINA MISTA 4 FUOCHI CON FORNO ELETTRICO MULTIFUNZIONE - CAMERA CM. 64X37X35H, TEMP: 50÷250°C, CON 1 GRIGLIA CM.53X32,5 GN1/1 - PORTA VETRO
EN Combined range - N. 4 burners Multifunction oven - Chamber cm. 64x37x35h, temp: 50÷250°C, with 1 grid cm.53x32,5 GN1/1 - Glass door • DE Gemischtherd - N. 4 Kochstellen Multifunktions-Ofen cm. 64x37x35h, temp: 50÷250°C, with 1 grid cm.53x32,5 GN1/1 - Glasstür • FR Cuisinière mixte - N. 4 feux vifs Four à fonctions multiples cm. 64x37x35h, temp: 50÷250°C, avec 1 grille cm.53x32,5 GN1/1 - Porte vitrée • ES Cocina mixta - N. 4 quemadores Horno multifuncional - Cámara cm. 64x37x35h, temp: 50÷250°C, con 1 parilla cm.53x32,5 GN1/1 - Puerta vidrio
cm. 80x 60x 90h



⚡ 18 kW _____ **4.461,00**
15.480 kcal/h _____ 98 / 0,62

⚡ 3,05 kW _____
230V~ _____
50/60 Hz _____

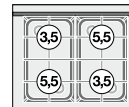

CUCINE A GAS CON FORNO ELETTRICO

MOD. _____
COD. _____

DESCRIZIONE/DESCRIPTION/BEZEICHNUNG/DESCRIPTION/DESCRIPCIÓN
DIMENSIONI/DIMENSIONS/ABMESSUNGEN/DIMENSIONS/DIMENSIONES

POTENZA/POWER/LEISTUNG/PUISSANCE/POTENCIA
VOLTAGGIO/VOLTAGE/SPANNUNG/VOLTAGE/VOLTAJE

⚡ kW _____
kcal/h _____
⚡ kW _____
V~ _____
Hz _____

PREZZO/PRICE
PREIS/PRIX/PRECIO
KG / M³



CFM4-68GEM CUCINA MISTA 4 FUOCHI CON FORNO ELETTRICO
06690863 **MULTIFUNZIONE - CAMERA CM. 64X37X35H, TEMP: 50÷250°C, CON 1 GRIGLIA CM.53X32,5 GN1/1 - PORTA CIECA INOX**

EN Combined range - N. 4 burners Multifunction oven - Chamber cm. 64x37x35h, temp: 50÷250°C, with 1 grid cm.53x32,5 GN1/1 - Stainless steel door • **DE** Gemischtherd - N. 4 Kochstellen Multifunktions-Ofen cm. 64x37x35h, temp: 50÷250°C, with 1 grid cm.53x32,5 GN1/1 - Edelstahltür • **FR** Cuisinière mixte - N. 4 feux vifs Four à fonctions multiples cm. 64x37x35h, temp: 50÷250°C, avec 1 grille cm.53x32,5 GN1/1 - Porte acier inoxydable • **ES** Cocina mixta - N. 4 quemadores Horno multifuncional - Cámara cm. 64x37x35h, temp: 50÷250°C, con 1 parilla cm.53x32,5 GN1/1 - Puerta ciega inox
cm. 80x 60x 90h



⚡ 18 kW _____ **4.461,00**
15.480 kcal/h 98 / 0,62

⚡ 3,05 kW _____
230V~
50/60 Hz

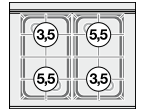

CFM6-610GEM CUCINA MISTA 6 FUOCHI CON FORNO ELETTRICO
06691062 **MULTIFUNZIONE - CAMERA CM. 64X37X35H, TEMP: 50÷250°C, CON 1 GRIGLIA CM.53X32,5 GN1/1 - PORTA VETRO**

EN Combined range - N. 6 burners Multifunction oven - Chamber cm. 64x37x35h, temp: 50÷250°C, with 1 grid cm.53x32,5 GN1/1 - Glass door • **DE** Gemischtherd - N. 6 Kochstellen Multifunktions-Ofen cm. 64x37x35h, temp: 50÷250°C, mit 1 Rost cm.53x32,5 GN1/1 - Glastür • **FR** Cuisinière mixte - N. 6 feux vifs Four à fonctions multiples cm. 64x37x35h, temp: 50÷250°C, avec 1 grille cm.53x32,5 GN1/1 - Porte vitrée • **ES** Cocina mixta - N. 6 quemadores Horno multifuncional - Cámara cm. 64x37x35h, temp: 50÷250°C, con 1 parilla cm.53x32,5 GN1/1 - Puerta vidrio
cm. 100x 60x 90h



⚡ 27 kW _____ **4.991,00**
23.193 kcal/h 107 / 0,77

⚡ 3,05 kW _____
230V~
50/60 Hz

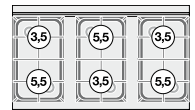

CFM6-610GEM CUCINA MISTA 6 FUOCHI CON FORNO ELETTRICO
06691063 **MULTIFUNZIONE - CAMERA CM. 64X37X35H, TEMP: 50÷250°C, CON 1 GRIGLIA CM.53X32,5 GN1/1 - PORTA CIECA INOX**

EN Combined range - N. 6 burners Multifunction oven - Chamber cm. 64x37x35h, temp: 50÷250°C, with 1 grid cm.53x32,5 GN1/1 - Stainless steel door • **DE** Gemischtherd - N. 6 Kochstellen Multifunktions-Ofen cm. 64x37x35h, temp: 50÷250°C, mit 1 Rost cm.53x32,5 GN1/1 - Edelstahltür • **FR** Cuisinière mixte - N. 6 feux vifs Four à fonctions multiples cm. 64x37x35h, temp: 50÷250°C, avec 1 grille cm.53x32,5 GN1/1 - Porte acier inoxydable • **ES** Cocina mixta - N. 6 quemadores Horno multifuncional - Cámara cm. 64x37x35h, temp: 50÷250°C, con 1 parilla cm.53x32,5 GN1/1 - Puerta ciega inox
cm. 100x 60x 90h



⚡ 27 kW _____ **4.991,00**
23.193 kcal/h 107 / 0,77

⚡ 3,05 kW _____
230V~
50/60 Hz

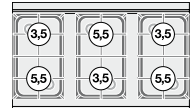

TPF4-610G TUTTA PIASTRA + 4 FUOCHI FORNO A GAS STATICO CON GRILL CM. 64X39X35H, TEMP: 125÷275°C, CON 1 GRIGLIA CM.53X32,5 GN1/1 - PIASTRA CM. 37X50 - PORTA VETRO
06721050

EN Solid top + 4 burners on Gas static oven with grill cm. 64x39x35h, temp: 125÷275°C, with 1 grid cm.53x32,5 GN1/1, Plate cm. 37x50 - Glass door • **DE** Kochplatte + 4 Gaskochstellen auf Gas statischer Backofen mit grill cm. 64x39x35h, temp: 125÷275°C, mit 1 Rost cm.53x32,5 GN1/1 Platte cm. 37x50 - Glastür • **FR** Toute plaque + 4 brûleurs sur Four gaz statique avec grill cm. 64x39x35h, temp: 125÷275°C, avec 1 grille cm.53x32,5 GN1/1 Plaque cm. 37x50 - Porte vitrée • **ES** Placa de cocción + 4 fuegos con Horno gas estático con asador cm. 64x39x35h, temp: 125÷275°C, con 1 parilla cm.53x32,5 GN1/1, Placa cm. 37x50 - Puerta vidrio
cm. 100x 60x 90h



⚡ 27,5 kW _____ **5.040,00**
23.650 kcal/h 165 / 0,77

⚡ 0,015 kW _____
230V~
50/60 Hz

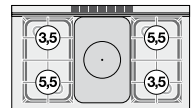

TPF4-610G TUTTA PIASTRA + 4 FUOCHI FORNO A GAS STATICO CON GRILL CM. 64X39X35H, TEMP: 125÷275°C, CON 1 GRIGLIA CM.53X32,5 GN1/1 - PIASTRA CM. 37X50 - PORTA CIECA INOX
06721051

EN Solid top + 4 burners on Gas static oven with grill cm. 64x39x35h, temp: 125÷275°C, with 1 grid cm.53x32,5 GN1/1, Plate cm. 37x50 - Stainless steel door • **DE** Kochplatte + 4 Gaskochstellen auf Gas statischer Backofen mit grill cm. 64x39x35h, temp: 125÷275°C, mit 1 Rost cm.53x32,5 GN1/1 Platte cm. 37x50 - Edelstahltür • **FR** Toute plaque + 4 brûleurs sur Four gaz statique avec grill cm. 64x39x35h, temp: 125÷275°C, avec 1 grille cm.53x32,5 GN1/1 Plaque cm. 37x50 - Porte acier inoxydable • **ES** Placa de cocción + 4 fuegos con Horno gas estático con asador cm. 64x39x35h, temp: 125÷275°C, con 1 parilla cm.53x32,5 GN1/1, Placa cm. 37x50 - Puerta ciega inox
cm. 100x 60x 90h



⚡ 27,5 kW _____ **5.040,00**
23.650 kcal/h 165 / 0,77

⚡ 0,015 kW _____
230V~
50/60 Hz

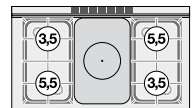

TUTTAPIASTRA A GAS CON FORNO ELETTRICO

MOD. _____
COD. _____

DESCRIZIONE/DESCRIPTION/BEZEICHNUNG/DESCRIPTION/DESCRIPCIÓN
DIMENSIONI/DIMENSIONS/ABMESSUNGEN/DIMENSIONS/DIMENSIONES

POTENZA/POWER/LEISTUNG/PUISSANCE/POTENCIA
VOLTAGGIO/VOLTAGE/SPANNUNG/VOLTAGE/VOLTAJE

⚡ 23,5 kW
20.210 kcal/h

PREZZO/PRICE
PREIS/PRIX/PRECIO
KG / M³



TPF4-610GEM TUTTA PIASTRA + 4 FUOCHI CON FORNO ELETTRICO STATICO
06731060
- CAMERA CM. 64X42X35H, TEMP: 50÷250°C, CON 1 GRIGLIA CM.53X32,5 GN1/1 - PIASTRA CM. 37X50 - PORTA VETRO

EN Solid top + 4 burners Traditional electric oven - chamber cm 64x42x35h, temp: 50÷250°C, with 1 grid cm.53x32,5 GN1/1, Plate cm. 37x50 - Glass door • **DE** Kochplatte + 4 Gaskochstellen Statischer elektro-backofen cm. 64x42x35h, temp: 50÷250°C, mit 1 Rost cm.53x32,5 GN1/1 Platte cm. 37x50 - Glasür • **FR** Toute plaque + 4 brûleurs vifs Four électrique statique chambre cm.64x42x35h, temp: 50÷250°C, avec 1 grille cm.53x32,5 GN1/1 Plaque cm. 37x50 - Porte vitrée • **ES** Placa de cocción + 4 fuegos Horno eléctrico estático cámara cm. 64x42x35h, temp: 50÷250°C, con 1 parilla cm.53x32,5 GN1/1, Placa cm. 37x50 - Puerta vidrio
cm. 100x 60x 90h



⚡ 23,5 kW **4.810,00**
20.210 kcal/h 165 / 0,77

⚡ 2,62 kW
230V~
50/60 Hz

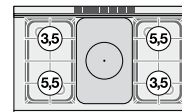

TPF4-610GEM TUTTA PIASTRA + 4 FUOCHI CON FORNO ELETTRICO STATICO
06731061
- CAMERA CM. 64X42X35H, TEMP: 50÷250°C, CON 1 GRIGLIA CM.53X32,5 GN1/1 - PIASTRA CM. 37X50 - PORTA CIECA INOX

EN Solid top + 4 burners Traditional electric oven - chamber cm 64x42x35h, temp: 50÷250°C, with 1 grid cm.53x32,5 GN1/1, Plate cm. 37x50 - Stainless steel door • **DE** Kochplatte + 4 Gaskochstellen Statischer elektro-backofen cm. 64x42x35h, temp: 50÷250°C, mit 1 Rost cm.53x32,5 GN1/1 Platte cm. 37x50 - Edelstahltür • **FR** Toute plaque + 4 brûleurs vifs Four électrique statique chambre cm.64x42x35h, temp: 50÷250°C, avec 1 grille cm.53x32,5 GN1/1 Plaque cm. 37x50 - Porte acier inoxydable • **ES** Placa de cocción + 4 fuegos Horno eléctrico estático cámara cm. 64x42x35h, temp: 50÷250°C, con 1 parilla cm.53x32,5 GN1/1, Placa cm. 37x50 - Puerta ciega inox
cm. 100x 60x 90h



⚡ 23,5 kW **4.810,00**
20.210 kcal/h 165 / 0,77

⚡ 2,62 kW
230V~
50/60 Hz

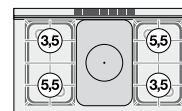

TPFM4-610GEM TUTTA PIASTRA + 4 FUOCHI CON FORNO ELETTRICO MULTIFUNZIONE CM. 64X37X35H, TEMP: 50÷250°C, CON 1 GRIGLIA CM.53X32,5 GN1/1 - PIASTRA CM. 37X50 - PORTA VETRO
06731062

EN Solid top + 4 burners Multifunction electric oven cm. 64x37x35h, temp: 50÷250°C, with 1 grid cm.53x32,5 GN1/1, Plate cm. 37x50 - Glass door • **DE** Kochplatte + 4 Gaskochstellen Multifunktions-Elektroofen cm. 64x37x35h, temp: 50÷250°C, mit 1 Rost cm.53x32,5 GN1/1 Platte cm. 37x50 - Glasür • **FR** Toute plaque + 4 brûleurs vifs Four électrique à fonctions multiples cm. 64x37x35h, temp: 50÷250°C, avec 1 grille cm.53x32,5 GN1/1 Plaque cm. 37x50 - Porte vitrée • **ES** Placa de cocción + 4 fuegos Horno eléctrico multifuncional cm. 64x37x35h, temp: 50÷250°C, con 1 parilla cm.53x32,5 GN1/1, Placa cm. 37x50 - Puerta vidrio
cm. 100x 60x 90h



⚡ 23,5 kW **6.203,00**
20.210 kcal/h 166 / 0,77

⚡ 3,05 kW
230V~
50/60 Hz

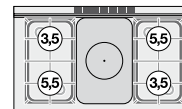

TPFM4-610GEM TUTTA PIASTRA + 4 FUOCHI CON FORNO ELETTRICO MULTIFUNZIONE CM. 64X37X35H, TEMP: 50÷250°C, CON 1 GRIGLIA CM.53X32,5 GN1/1 - PIASTRA CM. 37X50 - PORTA CIECA INOX
06731063

EN Solid top + 4 burners Multifunction electric oven cm. 64x37x35h, temp: 50÷250°C, with 1 grid cm.53x32,5 GN1/1, Plate cm. 37x50 - Stainless steel door • **DE** Kochplatte + 4 Gaskochstellen Multifunktions-Elektroofen cm. 64x37x35h, temp: 50÷250°C, mit 1 Rost cm.53x32,5 GN1/1 Platte cm. 37x50 - Edelstahltür • **FR** Toute plaque + 4 brûleurs vifs Four électrique à fonctions multiples cm. 64x37x35h, temp: 50÷250°C, avec 1 grille cm.53x32,5 GN1/1 Plaque cm. 37x50 - Porte acier inoxydable • **ES** Placa de cocción + 4 fuegos Horno eléctrico multifuncional cm. 64x37x35h, temp: 50÷250°C, con 1 parilla cm.53x32,5 GN1/1, Placa cm. 37x50 - Puerta ciega inox
cm. 100x 60x 90h



⚡ 23,5 kW **6.203,00**
20.210 kcal/h 166 / 0,77

⚡ 3,05 kW
230V~
50/60 Hz

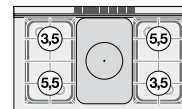

CUCINE ELETTRICHE

MOD. _____
COD. _____

DESCRIZIONE/DESCRIPTION/BEZEICHNUNG/DESCRIPTION/DESCRIPCIÓN
DIMENSIONI/DIMENSIONS/ABMESSUNGEN/DIMENSIONS/DIMENSIONES

POTENZA/POWER/LEISTUNG/PUISSANCE/POTENCIA
VOLTAGGIO/VOLTAGE/SPANNUNG/VOLTAGE/VOLTAJE

⚡ 9,05 kW
400V~3N
230V~3
230V~
50/60 Hz

PREZZO/PRICE
PREIS/PRIX/PRECIO
KG / M³



CFMC4-66ET CUCINA CON PIANO IN VETROCERAMICA VETRO CM. 58X44
06670632 **FORNO MULTIFUNZIONE - CAMERA CM. 46X37X35H, TEMP: 50÷250°C, CON 1 GRIGLIA CM.41X32,5 - PORTA VETRO**
EN Range threephase - Ceramic, Glass: cm. 58x44 Multifunction oven - Chamber cm. 46x37x35h, temp: 50÷250°C, with 1 grid cm.41x32,5 - Glass door • **DE** Elektroherd dreiphasing - Ceran-Kochfläche cm. 58x44 Multifunktions-Ofen - cm. 46x37x35h, temp: 50÷250°C, mit 1 Rost cm.41x32,5 - Glastür • **FR** Cuisinière triphase - Vitrocéramique Plaque cm. 58x44 Four à fonctions multiples - cm. 46x37x35h, temp: 50÷250°C, avec 1 grille cm.41x32,5 - Porte vitrée • **ES** Cocina trifasica - Placa vitrocerámica, cristal cm. 58x44 Horno multifuncional - Cámara cm. 46x37x35h, temp: 50÷250°C, con 1 parilla cm.41x32,5 - Puerta vidrio cm. 60x 60x 90h



⚡ 9,05 kW
400V~3N
230V~3
230V~
50/60 Hz

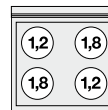

CFMC4-66ET CUCINA CON PIANO IN VETROCERAMICA VETRO CM. 58X44
06670633 **FORNO MULTIFUNZIONE - CAMERA CM. 46X37X35H, TEMP: 50÷250°C, CON 1 GRIGLIA CM.41X32,5 - PORTA CIECA INOX**
EN Range threephase - Ceramic, Glass: cm. 58x44 Multifunction oven - Chamber cm. 46x37x35h, temp: 50÷250°C, with 1 grid cm.41x32,5 - Stainless steel door • **DE** Elektroherd dreiphasing - Ceran-Kochfläche cm. 58x44 Multifunktions-Ofen - cm. 46x37x35h, temp: 50÷250°C, mit 1 Rost cm.41x32,5 - Edelstahltür • **FR** Cuisinière triphase - Vitrocéramique Plaque cm. 58x44 Four à fonctions multiples - cm. 46x37x35h, temp: 50÷250°C, avec 1 grille cm.41x32,5 - Porte acier inoxydable • **ES** Cocina trifasica - Placa vitrocerámica, cristal cm. 58x44 Horno multifuncional - Cámara cm. 46x37x35h, temp: 50÷250°C, con 1 parilla cm.41x32,5 - Puerta ciega inox cm. 60x 60x 90h



⚡ 9,05 kW
400V~3N
230V~3
230V~
50/60 Hz

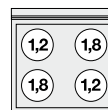

PT2/3-CFM66 PORTATEGLIE GN 2/3. PER CFM-66
06460023 **EN** Frame for oven plates GN 2/3, for CFM-66 • **DE** Auflangeschienen für Backbleche GN 2/3 für CFM-66 • **FR** Kit porte-plaques GN 2/3 pour CFM-66 • **ES** Portacazuelas GN2/3 para CFM-66

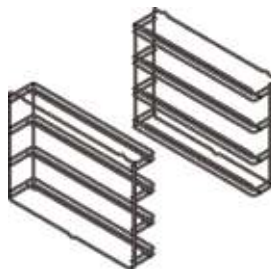

91,00
5 / 0,02

CF2-68G CUCINA A GAS 2 FUOCHI FORNO A GAS STATICO CON GRILL CM. 67X38X34H, TEMP: 125÷275°C, CON 1 GRIGLIA CM.65X36
06780851 **EN** Gas range - N. 2 burners - Gas static oven with grill cm. 67x38x34h, temp: 125÷275°C, with 1 grid cm.65x36 • **DE** Gasherd - N. 2 Kochstellen - Gas statischer Backofen mit Grill cm. 67x38x34h, temp: 125÷275°C, mit 1 Rost cm.65x36 • **FR** Forneau gaz - N. 2 feux vifs - Four a gaz statique avec grill cm. 67x38x34h, temp: 125÷275°C, avec 1 grille cm.65x36 • **ES** Cocina gas - N. 2 quemadores Horno a gas estático con asador cm. 67x38x34h, temp: 125÷275°C, con 1 parilla cm.65x36 cm. 80x 60x 90h



⚡ 21 kW
18.060 kcal/h

3.754,00
95 / 0,62

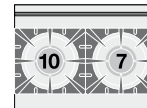

CF2-68GEM CUCINA MISTA 2 FUOCHI CON FORNO ELETTRICO STATICO CON GRILL CM. 67X38X34H, TEMP: 50÷250°C, CON 1 GRIGLIA CM.65X36
06790861 **EN** Combined range static oven - N. 2 burners Static oven cm. 67x38x34h, temp: 50÷250°C, with 1 grid cm.65x36 • **DE** Gemischtherd statischer Ofen - N. 2 Kochstellen Statistischer Ofen cm. 67x38x34h, temp: 50÷250°C, mit 1 Rost cm.65x36 • **FR** Cuisinière mixte gaz four estático - N. 2 feux vifs Four statique cm. 67x38x34h, temp: 50÷250°C, avec 1 grille cm.65x36 • **ES** Cocina mixta horno estático - N. 2 quemadores Horno estático cm. 67x38x34h, temp: 50÷250°C, con 1 parilla cm.65x36 cm. 80x 60x 90h



⚡ 17 kW
14.620 kcal/h

3.822,00
95 / 0,62

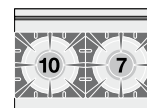

CUCINE A GAS CON FORNO ELETTRICO

MOD. _____
COD. _____

DESCRIZIONE/DESCRIPTION/BEZEICHNUNG/DESCRIPTION/DESCRIPCIÓN
DIMENSIONI/DIMENSIONS/ABMESSUNGEN/DIMENSIONS/DIMENSIONES

POTENZA/POWER/LEISTUNG/PUISSANCE/POTENCIA
VOLTAGGIO/VOLTAGE/SPANNUNG/VOLTAGE/VOLTAJE

⚡ kW _____
kcal/h _____
⚡ kW _____
V~ _____
Hz _____

PREZZO/PRICE
PREIS/PRIX/PRECIO
KG / M³



CFM2-68GEM CUCINA MISTA 2 FUOCHI CON FORNO ELETTRICO
06790862 **MULTIFUNZIONE CM. 64X37X35H, TEMP: 50÷250°C, CON 1 GRIGLIA CM.53X32,5 GN1/1 - PORTA VETRO**
EN Combined range - N. 2 burners Multifunction electric oven cm. 64x37x35h, temp: 50÷250°C, with 1 grid cm.53x32,5 GN1/1 - Glass door • **DE** Gemischtherd - N. 2 Kochstellen Multifunktions-Elektroofen cm. 64x37x35h, temp: 50÷250°C, mit 1 Rost cm.53x32,5 GN1/1 - Glastür • **FR** Cuisinière mixte - N. 2 feux vifs Four électrique à fonctions multiples cm. 64x37x35h, temp: 50÷250°C, avec 1 grille cm.53x32,5 GN1/1 - Porte acier inoxydable • **ES** Cocina mixta - N. 2 quemadores Horno eléctrico multifuncional cm. 64x37x35h, temp: 50÷250°C, con 1 parilla cm.53x32,5 GN1/1 - Puerta ciega inox
cm. 80x 60x 90h



⚡ 17 kW _____ **4.195,00**
14.620 kcal/h 96 / 0,62
⚡ 3,05 kW _____
230V~ _____
50/60 Hz _____

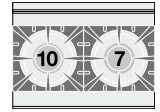

CFM2-68GEM CUCINA MISTA 2 FUOCHI CON FORNO ELETTRICO
06790863 **MULTIFUNZIONE CM. 64X37X35H, TEMP: 50÷250°C, CON 1 GRIGLIA CM.53X32,5 GN1/1 - PORTA CIEGA INOX**
EN Combined range - N. 2 burners Multifunction electric oven cm. 64x37x35h, temp: 50÷250°C, with 1 grid cm.53x32,5 GN1/1 - Stainless steel door • **DE** Gemischtherd - N. 2 Kochstellen Multifunktions-Elektroofen cm. 64x37x35h, temp: 50÷250°C, mit 1 Rost cm.53x32,5 GN1/1 - Edelstahltür • **FR** Cuisinière mixte - N. 2 feux vifs Four électrique à fonctions multiples cm. 64x37x35h, temp: 50÷250°C, avec 1 grille cm.53x32,5 GN1/1 - Porte acier inoxydable • **ES** Cocina mixta - N. 2 quemadores Horno eléctrico multifuncional cm. 64x37x35h, temp: 50÷250°C, con 1 parilla cm.53x32,5 GN1/1 - Puerta ciega inox
cm. 80x 60x 90h



⚡ 17 kW _____ **4.195,00**
14.620 kcal/h 96 / 0,62
⚡ 3,05 kW _____
230V~ _____
50/60 Hz _____

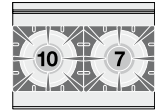

CF3-612GV CUCINA A GAS 3 FUOCHI FORNO A GAS STATICO CON GRILL CM. 67X38X34H, TEMP: 125÷275°C, CON 1 GRIGLIA CM.65X36, VANO NEUTRO CON PORTA.
06781251 **EN** Gas range - N. 3 burners - Gas static oven with grill cm. 67x38x34h, temp: 125÷275°C, with 1 grid cm.65x36 - Neutral cabinet with door • **DE** Gasherd - N. 3 Kochstellen - Gas statischer Backofen mit Grill cm. 67x38x34h, temp: 125÷275°C, mit 1 Rost cm.65x36 - Neutrales Schrankelement mit Tür • **FR** Forneau gaz - N. 3 feux vifs - Four a gaz statique avec grill cm. 67x38x34h, temp: 125÷275°C, avec 1 grille cm.65x36 - Element neutre avec porte • **ES** Cocina gas - N. 3 quemadores Horno a gas estático con asador cm. 67x38x34h, temp: 125÷275°C, con 1 parilla cm.65x36 - Armario neutro con puerta equipado
cm. 120x 60x 90h



⚡ 31 kW _____ **4.600,00**
26.660 kcal/h 102 / 0,92

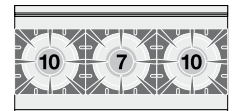

CF3-612GEMV CUCINA MISTA 3 FUOCHI CON FORNO ELETTRICO STATICO CON GRILL CM. 67X38X34H, TEMP: 50÷250°C, CON 1 GRIGLIA CM.65X36, VANO NEUTRO CON PORTA
06791261 **EN** Combined range static oven - N. 3 burners Static oven cm. 67x38x34h, temp: 50÷250°C, with 1 grid cm.65x36 - Neutral cabinet with door • **DE** Gemischtherd statischer Ofen - N. 3 Kochstellen Statischer Ofen cm. 67x38x34h, temp: 50÷250°C, mit 1 Rost cm.65x36 - Neutrales Schrankelement mit Tür • **FR** Cuisinière mixte gaz four estático - N. 3 feux vifs Four statique cm. 67x38x34h, temp: 50÷250°C, avec 1 grille cm.65x36 - Element neutre avec porte • **ES** Cocina mixta horno estático - N. 3 quemadores Horno estático cm. 67x38x34h, temp: 50÷250°C, con 1 parilla cm.65x36 - Armario neutro con puerta equipado
cm. 120x 60x 90h



⚡ 27 kW _____ **4.683,00**
23.220 kcal/h 102 / 0,92
⚡ 3,05 kW _____
230V~ _____
50/60 Hz _____

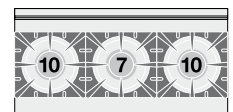

CFM3-612GEMV CUCINA MISTA 3 FUOCHI CON FORNO ELETTRICO MULTIFUNZIONE CM. 64X37X35H, TEMP: 50÷250°C, CON 1 GRIGLIA CM.53X32,5 GN1/1 - PORTA VETRO - VANO NEUTRO CON PORTA
06791262 **EN** Combined range - N. 3 burners Multifunction electric oven cm. 64x37x35h, temp: 50÷250°C, with 1 grid cm.53x32,5 GN1/1 - Glass door - Neutral cabinet with door • **DE** Gemischtherd - N. 3 Kochstellen Multifunktions-Elektroofen cm. 64x37x35h, temp: 50÷250°C, mit 1 Rost cm.53x32,5 GN1/1 - Glastür - Neutrales Schrankelement mit Tür • **FR** Cuisinière mixte - N. 3 feux vifs Four électrique à fonctions multiples cm. 64x37x35h, temp: 50÷250°C, avec 1 grille cm.53x32,5 GN1/1 - Porte acier inoxydable - Element neutre avec porte • **ES** Cocina mixta - N. 3 quemadores Horno eléctrico multifuncional cm. 64x37x35h, temp: 50÷250°C, con 1 parilla cm.53x32,5 GN1/1 - Puerta ciega inox - Armario neutro con puerta equipado
cm. 120x 60x 90h



⚡ 27 kW _____ **5.031,00**
23.220 kcal/h 103 / 0,92
⚡ 3,05 kW _____
230V~ _____
50/60 Hz _____

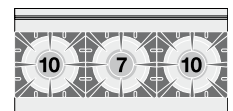

CUCINE A GAS CON FORNO ELETTRICO

MOD. _____
COD. _____

DESCRIZIONE/DESCRIPTION/BEZEICHNUNG/DESCRIPTION/DESCRIPCIÓN
DIMENSIONI/DIMENSIONS/ABMESSUNGEN/DIMENSIONS/DIMENSIONES

POTENZA/POWER/LEISTUNG/PUISSANCE/POTENCIA
VOLTAGGIO/VOLTAGE/SPANNUNG/VOLTAGE/VOLTAJE

⚡ kW _____
kcal/h _____
⚡ kw _____
V~ _____
Hz _____

PREZZO/PRICE
PREIS/PRIX/PRECIO
KG / M³



**CFM3-612GEMV CUCINA MISTA 3 FUOCHI CON FORNO ELETTRICO
MULTIFUNZIONE CM. 64X37X35H, TEMP: 50÷250°C, CON 1
GRIGLIA CM.53X32,5 GN1/1 - PORTA CIECA INOX - VANO
NEUTRO CON PORTA**

06791263

EN Combined range - N. 3 burners Multifunction electric oven cm. 64x37x35h, temp: 50÷250°C, with 1 grid cm.53x32,5 GN1/1 - Stainless steel door - Neutral cabinet with door • **DE** Gemischtherd - N. 3 Kochstellen Multifunktions-Elektroofen cm. 64x37x35h, temp: 50÷250°C, mit 1 Rost cm.53x32,5 GN1/1 - Edelstahltür - Neutrales Schrankelement mit Tür • **FR** Cuisinière mixte - N. 3 feux vifs Four électrique à fonctions multiples cm. 64x37x35h, temp: 50÷250°C, avec 1 grille cm.53x32,5 GN1/1 - Porte acier inoxydable - Element neutre avec porte • **ES** Cocina mixta - N. 3 quemadores Horno eléctrico multifuncional cm. 64x37x35h, temp: 50÷250°C, con 1 parrilla cm.53x32,5 GN1/1 - Puerta ciega inox - Armario neutro con puerta equipado
cm. 120x 60x 90h



⚡ 27 kW _____ **5.031,00**
23.220 kcal/h _____ 103 / 0,92

⚡ 3,05 kW _____
230V~ _____
50/60 Hz _____

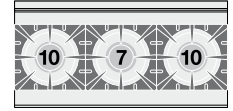

**CPT-64ET CUOCIPASTA TRIFASE LT. 17 VASCA CM. 31X33,5X22H.
RUBINETTO SCARICO (CESTI ESCLUSI)**

16100430

EN Pasta cooker threephase 17 lts. Tank cm. 31x33,5x22h. Drain-tap (BASKETS EXCLUDED) • **DE** Nudelkocher dreiphasig lt.17 Becken cm. 31x33,5x22h. Ablasshahn (KORB AUSGESCHLOSSEN) • **FR** Cuiseur à pâtes triphase lt.17 Cuve cm. 31x33,5x22h. Robinet de vidange (PANIERS EXCLUS) • **ES** Cucee pasta trifásico lt.17 Cuba cm. 31x33,5x22h. Grifo descarga (CESTAS EXCLUIDAS)
cm. 40x 60x 28h



⚡ 4,1 kW _____ **1.779,00**
400V~3N _____ 27 / 0,19
230V~ _____
50/60 Hz _____

COMBINAZIONI

- Combinations / • Zusammenstellungen
- Combinaisons / • Combinación múltiple



**CPT-66ET CUOCIPASTA TRIFASE LT. 25 VASCA CM. 51X31X22H.
RUBINETTO SCARICO (CESTI ESCLUSI)**

16100630

EN Pasta cooker threephase 25 lts. Tank cm. 51x31x22h. Drain-tap (BASKETS EXCLUDED) • **DE** Nudelkocher dreiphasig lt.25 Becken cm. 51x31x22h. Ablasshahn (KORB AUSGESCHLOSSEN) • **FR** Cuiseur à pâtes triphase lt.25 Cuve cm. 51x31x22h. Robinet de vidange (PANIERS EXCLUS) • **ES** Cucee pasta trifásico lt.25 Cuba cm. 51x31x22h. Grifo descarga (CESTAS EXCLUIDAS)
cm. 60x 60x 28h



⚡ 6,25 kW _____ **1.976,00**
400V~3N _____ 42 / 0,28
50/60 Hz _____

COMBINAZIONI

- Combinations / • Zusammenstellungen
- Combinaisons / • Combinación múltiple



**CPT-64G CUOCIPASTA A GAS CAPACITA' LT. 13 VASCA CM.
31X33,5X18H. RUBINETTO SCARICO (CESTI ESCLUSI)**

16270450

EN Gas pasta cookers Tank capacity 13 lts. Tank cm. 31x33,5x18h. Drain-tap (BASKETS EXCLUDED) • **DE** Gas -Nudelkocher Beckeninhalte lt.13 Becken cm. 31x33,5x18h. Ablasshahn (KORB AUSGESCHLOSSEN) • **FR** Cuiseur à pâtes gaz Cuve lt.13 Cuve cm. 31x33,5x18h. Robinet de vidange (PANIERS EXCLUS) • **ES** Cucee pasta gas Cuba 13 lt. Cuba cm. 31x33,5x18h. Grifo descarga (CESTAS EXCLUIDAS)
cm. 40x 60x 28h



⚡ 6 kW _____ **1.806,00**
5.160 kcal/h _____ 30 / 0,19

COMBINAZIONI

- Combinations / • Zusammenstellungen
- Combinaisons / • Combinación múltiple



CUOCIPASTA A GAS - TOP

MOD. _____
COD. _____

DESCRIZIONE/DESCRIPTION/BEZEICHNUNG/DESCRIPTION/DESCRIPCIÓN
DIMENSIONI/DIMENSIONS/ABMESSUNGEN/DIMENSIONS/DIMENSIONES

POTENZA/POWER/LEISTUNG/PUISSANCE/POTENCIA
VOLTAGGIO/VOLTAGE/SPANNUNG/VOLTAGE/VOLTAJE

⚡ kW kcal/h
⚡ kW kcal/h
V~ Hz

PREZZO/PRICE
PREIS/PRIX/PRECIO
KG / M³



CPT-66G
16270650

CUOCIPASTA A GAS CAPACITA' LT. 19 VASCA CM. 51X31X18H. RUBINETTO SCARICO (CESTI ESCLUSI)

EN Gas pasta cookers Tank capacity 19 lts. Tank cm. 51x31x18h. Drain-tap (BASKETS EXCLUDED) • **DE** Gas -Nudelkocher Beckeninhalte lt. 19 Becken cm. 51x31x18h. Ablasshahn (KORB AUSGESCHLOSSEN) • **FR** Cuiseur à pâtes gaz Cuve lt.19 Cuve cm. 51x31x18h. Robinet de vidange (PANIERS EXCLUS) • **ES** Cucece pasta gas Cuba 19 lt. Cuba cm. 51x31x18h. Grifo descarga (CESTAS EXCLUIDAS)
cm. 60x 60x 28h



⚡ 9 kW
7.740 kcal/h
2.126,00
45 / 0,28

COMBINAZIONI

- Combinations / • Zusammenstellungen
- Combinaisons / • Combinación múltiple



CP-66ET
06100630

CUOCIPASTA TRIFASE LT. 40 VASCA CM. 51X30,7X32,7H. RUBINETTO CARICO ACQUA, SFIORATORE + SCARICO A PAVIMENTO (CESTI ESCLUSI)

EN Pasta cooker threephase 40 lts. - Tank cm. 51x30,7x32,7h. Water loading tap + overflow device and floor draining (BASKETS EXCLUDED) • **DE** Nudelkocher dreiphasig lt. 40 - Becken cm. 51x30,7x32,7h. Wasserlauf-Hahn + Überlauf-Vorrichtung und Ablauf am Boden (KORB AUSGESCHLOSSEN) • **FR** Cuiseur a pâtes triphase lt. 40 - Cuve cm. 51x30,7x32,7h. Robinet d'arrivée d'eau trop plein + système de vidange au sol (PANIERS EXCLUS) • **ES** Cucece pasta trifásico lt. 40 - Cuba cm. 51x30,7x32,7h. Grifo carga agua + vertedero + descarga a pavimento (CESTAS EXCLUIDAS)
cm. 60x 60x 90h



⚡ 13,5 kW
400V~3N
50/60 Hz
3.443,00
81 / 0,47

COMBINAZIONI

- Combinations / • Zusammenstellungen
- Combinaisons / • Combinación múltiple



CPA-66ET
06100635

CUOCIPASTA TRIFASE LT. 40 VASCA CM. 51X30,7X32,7H. CARICO ACQUA AUTOMATICO CON SENSORE DI LIVELLO - SFIORATORE + SCARICO A PAVIMENTO (CESTI ESCLUSI)

EN Pasta cooker threephase 40 lts. - Tank cm. 51x30,7x32,7h. - Automatic Water loading with level sensor - overflow device and floor draining (BASKETS EXCLUDED) • **DE** Nudelkocher dreiphasig lt. 40 - Becken cm. 51x30,7x32,7h. Automatische Wasser Beladung mit Niveauregulierung + Überlauf-Vorrichtung und Ablauf am Boden (KORB AUSGESCHLOSSEN) • **FR** Cuiseur a pâtes triphase lt. 40 - Cuve cm. 51x30,7x32,7h. Chargement automatique de l'eau avec sensor de niveau, trop plein Système de vidange au sol (PANIERS EXCLUS) • **ES** Cucece pasta trifásico lt. 40 - Cuba cm. 51x30,7x32,7h. Carga automática de agua con sensor de nivel + vertedero + descarga a pavimento. (CESTAS EXCLUIDAS)
cm. 60x 60x 90h



⚡ 13,5 kW
400V~3N
50/60 Hz
3.912,00
82 / 0,47

COMBINAZIONI

- Combinations / • Zusammenstellungen
- Combinaisons / • Combinación múltiple



CUOCIPASTA A GAS

MOD. _____
COD. _____

DESCRIZIONE/DESCRIPTION/BEZEICHNUNG/DESCRIPTION/DESCRIPCIÓN
DIMENSIONI/DIMENSIONS/ABMESSUNGEN/DIMENSIONS/DIMENSIONES

POTENZA/POWER/LEISTUNG/PUISSANCE/POTENCIA
VOLTAGGIO/VOLTAGE/SPANNUNG/VOLTAGE/VOLTAJE

⚡ $\frac{\text{kW}}{\text{kcal/h}}$ ⚡ $\frac{\text{kW}}{\text{V~}}$
Hz

PREZZO/PRICE
PREIS/PRIX/PRECIO
KG / M³



CP-66G
06270650

**CUOCIPASTA GAS LT. 40 VASCA CM. 51X30,7X32,7H.
RUBINETTO CARICO ACQUA, SFIORATORE + SCARICO A
PAVIMENTO (CESTI ESCLUSI)**

EN Gas pasta cooker on cabinet Tank capacity 40 lts. cm. 51x30,7x32,7h. Water loading tap + overflow device and floor draining (BASKETS EXCLUDED) • **DE** Gas-Nudelkocher Standgerät - Inhalt lt. 40 cm. 51x30,7x32,7h. Wasserlauf-Hahn + Überlauf-Vorrichtung und Ablauf am Boden (KORB AUSGESCHLOSSEN) • **FR** Cuiseur a pates sur coffre gaz - Cuve lt. 40 cm. 51x30,7x32,7h. Robinet d'arrivée d'eau trop plein + système de vidange au sol (PANIERS EXCLUS) • **ES** Cuece pasta gas - Cuba 40 lt. cm. 51x30,7x32,7h. Grifo carga agua + vertedero + descarga a pavimento (CESTAS EXCLUIDAS)
cm. 60x 60x 90h



⚡ $\frac{13,95 \text{ kW}}{11.997 \text{ kcal/h}}$ **3.834,00**
84 / 0,47
⚡ $\frac{0,02 \text{ KW}}{230\text{V~}}$
50/60 Hz

COMBINAZIONI

- Combinations / • Zusammenstellungen
- Combinaisons / • Combinación múltiple



CPA-66G
06270655

**CUOCIPASTA GAS LT. 40 VASCA CM. 51X30,7X32,7H.
CARICO ACQUA AUTOMATICO CON SENSORE DI LIVELLO -
SFIORATORE + SCARICO A PAVIMENTO (CESTI ESCLUSI)**

EN Gas pasta cooker on cabinet Tank capacity 40 lts. cm. 51x30,7x32,7h. Automatic Water loading with level sensor - overflow device and floor draining (BASKETS EXCLUDED) • **DE** Gas-Nudelkocher Standgerät - Inhalt lt. 40 cm. 51x30,7x32,7h. Automatische Wasser Beladung mit Niveauregulierung + Überlauf-Vorrichtung und Ablauf am Boden (KORB AUSGESCHLOSSEN) • **FR** Cuiseur a pates sur coffre gaz - Cuve lt. 40 cm. 51x30,7x32,7h. Chargement automatique de l'eau avec sensor de niveau, trop plein Système de vidange au sol (PANIERS EXCLUS) • **ES** Cuece pasta gas - Cuba 40 lt. cm. 51x30,7x32,7h. Carga automática de agua con sensor de nivel + vertedero + descarga a pavimento. (CESTAS EXCLUIDAS)
cm. 60x 60x 90h



⚡ $\frac{13,95 \text{ kW}}{11.997 \text{ kcal/h}}$ **4.099,00**
85 / 0,47
⚡ $\frac{0,035 \text{ KW}}{230\text{V~}}$
50/60 Hz

COMBINAZIONI

- Combinations / • Zusammenstellungen
- Combinaisons / • Combinación múltiple



CWKT-64ET
16080431

**GRIGLIA CONTACT - COTTURA DIRETTA SU RESISTENZA IN
ACCIAIO INOX CM. 27X35 RIBALTABILE**

EN CONTACT Grill threephase - Stainless steel grill cm. 27x35 • **DE** Wurstbrater dreiphasig KONTAKT - Einstellbarer Rost aus Nirosta cm. 27x35 • **FR** Grillade triphase CONTACT - Grille inox cm 27x35 • **ES** Parrilla trifásico CONTACT - Parrilla de acero inox regulable cm 27x35
cm. 40x 60x 28h



⚡ $\frac{3,36 \text{ kW}}{400\text{V~}3\text{N}}$ **2.602,00**
50/60 Hz 35 / 0,19

CWKT-68ET
16080831

**GRIGLIA CONTACT - COTTURA DIRETTA SU RESISTENZA IN
ACCIAIO INOX CM. 55X35 RIBALTABILE**

EN CONTACT Grill threephase - Stainless steel grill cm. 55x35 • **DE** Wurstbrater dreiphasig KONTAKT - Einstellbarer Rost aus Nirosta cm. 55x35 • **FR** Grillade triphase CONTACT - Grille inox cm 55x35 • **ES** Parrilla trifásico CONTACT - Parrilla de acero inox regulable cm 55x35
cm. 80x 60x 28h

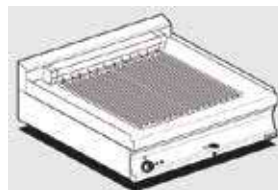

⚡ $\frac{6,72 \text{ kW}}{400\text{V~}3\text{N}}$ **3.496,00**
50/60 Hz 50 / 0,37

GRIGLIE ELETTRICHE - TOP

MOD. _____
COD. _____

DESCRIZIONE/DESCRIPTION/BEZEICHNUNG/DESCRIPTION/DESCRIPCIÓN
DIMENSIONI/DIMENSIONS/ABMESSUNGEN/DIMENSIONS/DIMENSIONES

POTENZA/POWER/LEISTUNG/PUISSANCE/POTENCIA
VOLTAGGIO/VOLTAGE/SPANNUNG/VOLTAGE/VOLTAJE

⚡ kW
kcal/h

⚡ kw
V~
Hz

PREZZO/PRICE
PREIS/PRIX/PRECIO
KG / M³



CWT-64ET
16080430

GRIGLIA ELETTRICA TRIFASE GRIGLIA IN ACCIAIO INOX CM. 38X42,5 REGOLABILE

EN Grill threephase - Stainless steel grill cm. 38x42,5 • **DE** Wurstbrater dreiphasig Einstellbarer Rost aus Nirosta cm. 38x42,5 • **FR** Grillade Triphase - Grille inox cm. 38x42,5 • **ES** Parrilla trifásico Parrilla de acero inox regulable cm. 38x42,5
cm. 40x 60x 28h



⚡ 4,8 kW
400V~3N
230V~3
50/60 Hz

1.830,00
36 / 0,19

CWT-66ET
16080630

GRIGLIA ELETTRICA TRIFASE GRIGLIA IN ACCIAIO INOX CM. 58X42,5 REGOLABILE

EN Grill threephase - Stainless steel grill cm. 58x42,5 • **DE** Wurstbrater dreiphasig Einstellbarer Rost aus Nirosta cm. 58x42,5 • **FR** Grillade Triphase - Grille inox cm. 58x42,5 • **ES** Parrilla trifásico Parrilla de acero inox regulable cm. 58x42,5
cm. 60x 60x 28h



⚡ 6,3 kW
400V~3N
230V~3
50/60 Hz

2.081,00
48 / 0,28

CWT-68ET
16080830

GRIGLIA ELETTRICA TRIFASE N. 2 GRIGLIE IN ACCIAIO INOX CM. 38X42,5 REGOLABILI 2 ZONE DI COTTURA

EN Grill threephase - N. 2 Stainless steel grill cm. 38x42,5 2 cooking areas • **DE** Wurstbrater dreiphasig - N. 2 einstellbarer Rost aus Nirosta cm. 38x42,5 - 2 Heizzonen • **FR** Grillade Triphase - N. 2 grilles réglables en acier inox cm. 38x42,5 - 2 zones de cuisson • **ES** Parrilla trifásico - N. 2 Parrillas de acero inox regulable cm. 38x42,5 - 2 zonas de cocción
cm. 80x 60x 28h



⚡ 9,6 kW
400V~3N
230V~3
50/60 Hz

2.831,00
52 / 0,37

CWT-64G
16250450

GRIGLIA A GAS-PIETRALAVICA GRIGLIA IN ACCIAIO INOX CM. 38X42,5 REGOLABILE

EN Charcoal grill gas - Stainless steel grill cm. 38x42,5 • **DE** Gas-Lavasteingrill - Einstellbarer Rost aus Nirosta cm. 38x42,5 • **FR** Grille à gaz en pierre de lave - Grille inox cm. 38x42,5 • **ES** Parrilla a gas piedra lávica Parrilla de acero inox regulable cm. 38x42,5
cm. 40x 60x 28h



⚡ 5,8 kW
4.988 kcal/h

1.912,00
41 / 0,19

CWT-66G
16250650

GRIGLIA A GAS-PIETRALAVICA GRIGLIA IN ACCIAIO INOX CM. 58X42,5 REGOLABILE

EN Charcoal grill gas - Stainless steel grill cm. 58x42,5 • **DE** Gas-Lavasteingrill - Einstellbarer Rost aus Nirosta cm. 58x42,5 • **FR** Grille à gaz en pierre de lave - Grille inox cm. 58x42,5 • **ES** Parrilla a gas piedra lávica Parrilla de acero inox regulable cm. 58x42,5
cm. 60x 60x 28h



⚡ 8,9 kW
7.654 kcal/h

2.291,00
58 / 0,28

CWT-68G
16250850

GRIGLIA A GAS-PIETRALAVICA N. 2 GRIGLIE IN ACCIAIO INOX CM. 38X42,5 REGOLABILI - 2 ZONE DI COTTURA

EN Charcoal grill gas N. 2 Stainless steel grill cm. 38x42,5 - 2 cooking areas • **DE** Gas-Lavasteingrill N. 2 einstellbarer Rost aus Nirosta cm. 38x42,5 - Heizzonen • **FR** Grille à gaz en pierre de lave N. 2 grilles réglables en acier inox cm. 38x42,5 - 2 zones de cuisson • **ES** Parrilla a gas piedra lávica N. 2 Parrillas de acero inox regulable cm. 38x42,5 - 2 zonas de cocción
cm. 80x 60x 28h



⚡ 11,6 kW
9.976 kcal/h

3.079,00
62 / 0,37

FRIGGITRICI ELETTRICHE - TOP

MOD. _____
COD. _____

DESCRIZIONE/DESCRIPTION/BEZEICHNUNG/DESCRIPTION/DESCRIPCIÓN
DIMENSIONI/DIMENSIONS/ABMESSUNGEN/DIMENSIONS/DIMENSIONES

POTENZA/POWER/LEISTUNG/PUISSANCE/POTENCIA
VOLTAGGIO/VOLTAGE/SPANNUNG/VOLTAGE/VOLTAJE

⚡ kcal/h
⚡ kW
V~
Hz

PREZZO/PRICE
PREIS/PRIX/PRECIO
KG / M³



F10T-63EM
16090310

**FRIGGITRICE ELETTRICA MONOFASE - VASCA LT. 10 CM.
22X35X23H CON FILTRO E COPERCHIO - CESTO CM.
20X30X10H PRODUZIONE PATATE 8 KG/H**

EN Fryer singlephase - Tank capacity 10 Lst. cm. 22x35x23h - Sieve and lid for pan - Basket cm. 20x30x10h - Production 8 kg/hr • **DE** Friteuse einphasig - Beckeninhalte lt. 10 cm. 22x35x23h - Einlegesieb und Deckel für Becken - Korb cm. 20x30x10h Pommes frites: 8 kg/pro Stunde • **FR** Friteuse monophasé - Cuve lt. 10 cm. 22x35x23h - Filtre, couvercle pour cuve - Panier 20x30x10h Production de pommes frites: 8 kg/h • **ES** Freidora monofásica - Cuba 10 lt cm. 22x35x23h - Filtro y tapa para cuba - Cesta cm. 20x30x10h Producción patatas 8 kg/h
cm. 30x 60x 28h



⚡ 3,65 kW
230V~
50/60 Hz
1.220,00
20 / 0,15

F10T-63ET
16090330

**FRIGGITRICE ELETTRICA TRIFASE - VASCA LT. 10 CM.
22X35X23H CON FILTRO E COPERCHIO - CESTO CM.
20X30X10H PRODUZIONE PATATE 10 KG/H**

EN Fryer threephase - Tank capacity 10 Lst. cm. 22x35x23h - Sieve and lid for pan - Basket cm. 20x30x10h - Production 10 kg/hr • **DE** Friteuse dreiphasing - Beckeninhalte lt. 10 cm. 22x35x23h - Einlegesieb und Deckel für Becken - Korb cm. 20x30x10h - Pommes frites: 10 kg/pro Stunde • **FR** Friteuse triphase - Cuve lt. 10 cm. 22x35x23h - Filtre, couvercle pour cuve - Panier 20x30x10h Production de pommes frites: 10 kg/h • **ES** Freidora trifásica - Cuba 10 lt cm. 22x35x23h - Filtro y tapa para cuba - Cesta cm. 20x30x10h Producción patatas 10 kg/h
cm. 30x 60x 28h

⚡ 7,15 kW
400V~3N
230V~3
50/60 Hz
1.413,00
21 / 0,15

F2/10T-66ET
16090630

**FRIGGITRICE ELETTRICA TRIFASE - VASCHE LT. 10+10 CM.
22X35X23H CON FILTRO E COPERCHIO - N. 2 CESTI CM.
20X30X10H PRODUZIONE PATATE 20 KG/H**

EN Fryer threephase - Tank capacity 10+10 Lst. cm. 22x35x23h - Sieve and lid for pan - N. 2 baskets cm. 20x30x10h - Production 20 kg/hr • **DE** Friteuse dreiphasing - Beckeninhalte lt. 10+10cm. 22x35x23h - Einlegesieb und Deckel für Becken - N. 2 Korbe cm. 20x30x10h - Pommes frites: 20 kg/pro Stunde • **FR** Friteuse triphase - Cuves lt. 10+10 cm. 22x35x23h - Filtre, couvercle pour cuve - N. 2 paniers 20x30x10h Production de pommes frites: 20 kg/h • **ES** Freidora trifásica - Cuba 10+10 lt. cm. 22x35x23h - Filtro y tapa para cuba - N. 2 cestas cm. 20x30x10h Producción patatas 20 kg/h
cm. 60x 60x 28h



⚡ 14,3 kW
400V~3N
230V~3
50/60 Hz
2.500,00
37 / 0,28

F2/10T-66EM
16090610

**FRIGGITRICE ELETTRICA MONOFASE - VACHE LT. 10+10 CM.
22X35X23H CON FILTRO E COPERCHIO - N. 2 CESTI CM.
20X30X10H PRODUZIONE PATATE 16 KG/H**

EN Fryer singlephase - Tank capacity 10+10 Lst. cm. 22x35x23h - Sieve and lid for pan - N. 2 baskets cm. 20x30x10h Production 16 kg/hr • **DE** Friteuse einphasig - Beckeninhalte lt. 10+10cm. 22x35x23h - Einlegesieb und Deckel für Becken - N. 2 Korbe cm. 20x30x10h Pommes frites: 16 kg/pro Stunde • **FR** Friteuse monophasé - Cuves lt. 10+10 cm. 22x35x23h - Filtre, couvercle pour cuve - N. 2 paniers 20x30x10h Production de pommes frites: 16 kg/h • **ES** Freidora monofásica - Cuba 10+10 lt. cm. 22x35x23h - Filtro y tapa para cuba - N. 2 cestas cm. 20x30x10h Producción patatas 16 kg/h
cm. 60x 60x 28h

⚡ 7,3 kW
230V~
50/60 Hz
2.119,00
34 / 0,28

F8T-63G
16260350

**FRIGGITRICE A GAS - VASCA LT. 8 CM. 22X27,5X22H - CON
FILTRO E COPERCHIO - CESTO 20X24X9H - PRODUZIONE
PATATE: 8 KG/H**

EN Gas fryer - Tank capacity 8 lts. cm. 22x27,5x22h - Basket cm. 20x24x9h - Production: 8kg/h • **DE** Gas-einzelfriteuse - Beckeninhalte lt. 8 cm. 22x27,5x22h - Korb cm. 20x24x9h - Pommes frites: 8 kg/pro Stunde • **FR** Friteuse gaz - Cuve lt. 8 cm. 22x27,5x22h - Panier 20x24x9h Production de pommes frites: 8 kg/h • **ES** Freidora gas - Cuba 8 lt. cm. 22x27,5x22h - Cesta cm. 20x24x9h Producción patatas: 8 kg/h
cm. 30x 60x 28h



⚡ 6 kW
5.160 kcal/h
1.691,00
23 / 0,15

FRIGGITRICI A GAS - TOP

MOD. _____
COD. _____

DESCRIZIONE/DESCRIPTION/BEZEICHNUNG/DESCRIPTION/DESCRIPCIÓN
DIMENSIONI/DIMENSIONS/ABMESSUNGEN/DIMENSIONS/DIMENSIONES

POTENZA/POWER/LEISTUNG/PUISSANCE/POTENCIA
VOLTAGGIO/VOLTAGE/SPANNUNG/VOLTAGE/VOLTAJE

⚡ kW
kcal/h

PREZZO/PRICE
PREIS/PRIX/PRECIO
KG / M³



F2/8T-66G
16260650

FRIGGITRICE A GAS - VASCHE LT. 8+8 CM. 22X27,5X22H - CON FILTRO E COPERCHIO - N. 2 CESTI 20X24X9H - PRODUZIONE PATATE: 16 KG/H

EN Gas fryer - Tank capacity 8+8 lts. cm. 22x27,5x22h - N. 2 baskets cm. 20x24x9h Production: 16 kg/h • **DE** Gas-einzelfriteuse - Beckeninhalt lt. 8+8 cm. 22x27,5x22h - N. 2 Korbe cm. 20x24x9h Pommes frites: 16 kg/pro Stunde • **FR** Friteuse gaz - Cuve lt. 8+8 cm. 22x27,5x22h - N. 2 paniers 20x24x9h - Production de pommes frites: 16 kg/h • **ES** Freidora gas - Cuba 8+8 lt. cm. 22x27,5x22h - N. 2 cestas cm. 20x24x9h Producción patatas: 16 kg/h
cm. 60x 60x 28h



⚡ 12 kW
10.320 kcal/h **2.936,00**
41 / 0,28

F13-64ET
06090430

FRIGGITRICE TRIFASE LT. 13 VASCA CM. 24X35X32H - 1 CESTO CM. 21X30X12H - FILTRO E COPERCHIO VASCA. BACINELLA RACCOGLIOLIO CON FILTRO. - PRODUZIONE PATATE: 10 KG/H

EN Fryer threephase 13 lts - Bowl cm. 24x35x32h - 1 basket cm. 21x30x12h. Sieve and lid for pan. - Drip tray with sieve. Production: 10 kg/h • **DE** Friteuse dreiphasig lt. 13 - Becken cm. 24x35x32h - 1 Korb cm. 21x30x12h. Einlegesieb und Deckel für Becken. - Fettauffangschale mit Sieb. Pommes frites: 10 kg/h • **FR** Friteuse triphase lt. 13 - Cuve cm. 24x35x32h - 1 Panier cm. 21x30x12h. Filtre, couvercle pour cuve. - Bac de récupération de l'huile avec filtre. Production de pommes frites: 10 kg/h • **ES** Freidoras trifásico 13 lt. - Cuba cm. 24x35x32h - 1 cesta cm. 21x30x12h. Filtro y tapa para cuba. Bandeja recoge aceite con filtro. Prod. patatas: 10 Kg/h
cm. 40x 60x 90h



⚡ 10,95 kW
400V~3N
50/60 Hz **2.939,00**
52 / 0,37

F13-64G
06260450

FRIGGITRICE GAS LT. 13 VASCA CM. 32,5X31,5X36H - 1 CESTO CM. 30X27,5X12H - FILTRO E COPERCHIO VASCA. BACINELLA RACCOGLIOLIO CON FILTRO. - PRODUZIONE PATATE: 10 KG/H

EN Gas fryer 13 lts - Bowl cm. 32,5x31,5x36h - 1 basket cm. 30x27,5x12h. Sieve and lid for pan. - Drip tray with sieve. Production: 10 kg/h • **DE** Gas-Friteuse lt. 13 - Becken cm. 32,5x31,5x36h - 1 Korb cm. 30x27,5x12h. Einlegesieb und Deckel für Becken. - Fettauffangschale mit Sieb. Pommes frites: 10 kg/h • **FR** Friteuse a gaz lt. 13 - Cuve cm. 32,5x31,5x36h - 1 Panier cm. 30x27,5x12h. Filtre, couvercle pour cuve. - Bac de récupération de l'huile avec filtre. Production de pommes frites: 10 kg/h • **ES** Freidoras a gas 13 lt. - Cuba cm. 32,5x31,5x36h - 1 cesta cm. 30x27,5x12h. Filtro y tapa para cuba. Bandeja recoge aceite con filtro. Prod. patatas: 10 Kg/h
cm. 40x 60x 90h



⚡ 10,5 kW
9.020 kcal/h **2.698,00**
60 / 0,37

FTLT-64ET
16060431

FRY-TOP ELETTRICO LISCIO, PIASTRA CM.39,5X45
EN Electric Fry-top smooth griddle, plate cm.39,5x45 • **DE** Griddleplatte elektrische glatt, platte cm.39,5x45 • **FR** Plaque électriques lisse, plaque cm.39,5x45 • **ES** Fry-top eléctrico liso, plancha cm.39,5x45
cm. 40x 60x 28h



⚡ 4,5 kW
400V~3N
230V~3
50/60 Hz **1.312,00**
49 / 0,19

FTLT-64ETS
16060434

FRY-TOP ELETTRICO LISCIO CROMATO SUPERCHROME (MOCA APPROVED), PIASTRA CM.39,5X45
EN Electric Fry-top smooth chromed griddle SUPERCHROME (Moca Approved), plate cm.39,5x45 • **DE** Griddleplatte elektrische glatt hartverchromt SUPERCHROME (Moca Approved), platte cm.39,5x45 • **FR** Plaque électriques lisse chromée SUPERCHROME (Moca Approved), plaque cm.39,5x45 • **ES** Fry-top eléctrico liso cromado SUPERCHROME (Moca Approved), plancha cm.39,5x45
cm. 40x 60x 28h

⚡ 4,5 kW
400V~3N
230V~3
50/60 Hz **1.801,00**
49 / 0,19

FTLT-64ETSS
16060430

FRY-TOP ELETTRICO LISCIO CROMO LUCIDO, PIASTRA CM.39,5X45
EN Electric Fry-top smooth POLISHED CHROME, plate cm.39,5x45 • **DE** Griddleplatte elektrische glatt POLIERTEM CHROM, platte cm.39,5x45 • **FR** Plaque électriques lisse CHROME POLI, plaque cm.39,5x45 • **ES** Fry-top eléctrico liso CROMO PULIDO, plancha cm.39,5x45
cm. 40x 60x 28h

⚡ 4,5 kW
400V~3N
230V~3
50/60 Hz **1.801,00**
49 / 0,19

FRY-TOP ELETTRICI - TOP

MOD. _____
COD. _____

DESCRIZIONE/DESCRIPTION/BEZEICHNUNG/DESCRIPTION/DESCRIPCIÓN
DIMENSIONI/DIMENSIONS/ABMESSUNGEN/DIMENSIONS/DIMENSIONES

POTENZA/POWER/LEISTUNG/PUISSANCE/POTENCIA
VOLTAGGIO/VOLTAGE/SPANNUNG/VOLTAGE/VOLTAJE

⚡ kW kcal/h
⚡ kw V~ Hz

PREZZO/PRICE
PREIS/PRIX/PRECIO
KG / M³



FTRT-64ET
16060433

FRY-TOP ELETTRICO RIGATO, PIASTRA CM.39,5X45
EN Electric Fry-top grooved griddle, plate cm.39,5x45 • **DE** Griddleplatte elektrische gerillt, platte cm.39,5x45 • **FR** Plaque électriques nervurée, plaque cm.39,5x45 • **ES** Fry-top eléctrico estriado, plancha cm.39,5x45
cm. 40x 60x 28h

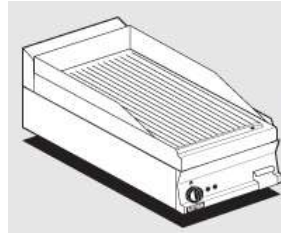

⚡ 4,5 kW **1.507,00**
400V~3N 49 / 0,19
230V~3
50/60 Hz



FTRT-64ETS
16060436

FRY-TOP ELETTRICO RIGATO CROMATO SUPERCHROME (MOCA APPROVED), PIASTRA CM.39,5X45
EN Electric Fry-top grooved chromed griddle SUPERCHROME (Moca Approved), plate cm.39,5x45 • **DE** Griddleplatte elektrische gerillt hartverchromt SUPERCHROME (Moca Approved), platte cm.39,5x45 • **FR** Plaque électriques nervurée chromée SUPERCHROME (Moca Approved), plaque cm.39,5x45 • **ES** Fry-top eléctrico estriado cromado SUPERCHROME (Moca Approved), plancha cm.39,5x45
cm. 40x 60x 28h

⚡ 4,5 kW **1.974,00**
400V~3N 49 / 0,19
230V~3
50/60 Hz



FTLT-66ET
16060631

FRY-TOP ELETTRICO LISCIO, PIASTRA CM.59,5X45 - 2 ZONE DI COTTURA
EN Electric Fry-top smooth griddle, plate cm.59,5x45 - 2 cooking areas • **DE** Griddleplatte elektrische glatt, platte cm.59,5x45 - 2 Heizzonen • **FR** Plaque électriques lisse, plaque cm.59,5x45 - 2 zones de cuisson • **ES** Fry-top eléctrico liso, plancha cm.59,5x45 - 2 zonas de cocción
cm. 60x 60x 28h



⚡ 6,75 kW **1.722,00**
400V~3N 66 / 0,28
230V~3
50/60 Hz

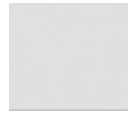

FTLT-66ETS
16060634

FRY-TOP ELETTRICO LISCIO CROMATO SUPERCHROME (MOCA APPROVED), PIASTRA CM.59,5X45 - 2 ZONE DI COTTURA
EN Electric Fry-top smooth chromed griddle SUPERCHROME (Moca Approved), plate cm.59,5x45 - 2 cooking areas • **DE** Griddleplatte elektrische glatt hartverchromt SUPERCHROME (Moca Approved), platte cm.59,5x45 - 2 Heizzonen • **FR** Plaque électriques lisse chromée SUPERCHROME (Moca Approved), plaque cm.59,5x45 - 2 zones de cuisson • **ES** Fry-top eléctrico liso cromado SUPERCHROME (Moca Approved), plancha cm.59,5x45 - 2 zonas de cocción
cm. 60x 60x 28h

⚡ 6,75 kW **2.330,00**
400V~3N 66 / 0,28
230V~3
50/60 Hz



FTLT-66ETSS
16060630

FRY-TOP ELETTRICO LISCIO CROMO LUCIDO, PIASTRA CM.59,5X45 - 2 ZONE DI COTTURA
EN Electric Fry-top smooth POLISHED CHROME, plate cm.59,5x45 - 2 cooking areas • **DE** Griddleplatte elektrische glatt POLIERTEM CHROM, platte cm.59,5x45 - 2 Heizzonen • **FR** Plaque électriques lisse CHROME POLI, plaque cm.59,5x45 - 2 zones de cuisson • **ES** Fry-top eléctrico liso CROMO PULIDO, plancha cm.59,5x45 - 2 zonas de cocción
cm. 60x 60x 28h

⚡ 6,75 kW **2.330,00**
400V~3N 66 / 0,28
230V~3
50/60 Hz

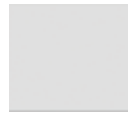

FTLRT-66ET
16060632

FRY-TOP ELETTRICO 1/2 RIGATO + 1/2 LISCIO, PIASTRA CM.59,5X45 - 2 ZONE DI COTTURA
EN Electric Fry-top 1/2 grooved + 1/2 smooth, plate cm.59,5x45 - 2 cooking areas • **DE** Griddleplatte elektrische 1/2 gerillt + 1/2 glatt, platte cm.59,5x45 - 2 Heizzonen • **FR** Plaque électriques 1/2 nervurée + 1/2 lisse, plaque cm.59,5x45 - 2 zones de cuisson • **ES** Fry-top eléctrico 1/2 estriado + 1/2 liso, plancha cm.59,5x45 - 2 zonas de cocción
cm. 60x 60x 28h

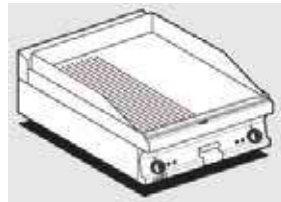

⚡ 6,75 kW **1.875,00**
400V~3N 66 / 0,28
230V~3
50/60 Hz



FTLRT-66ETS
16060635

FRY-TOP ELETTRICO 1/2 RIGATO + 1/2 LISCIO CROMATO SUPERCHROME (MOCA APPROVED), PIASTRA CM.59,5X45 - 2 ZONE DI COTTURA
EN Electric Fry-top 1/2 grooved + 1/2 smooth chromed griddle SUPERCHROME (Moca Approved), plate cm.59,5x45 - 2 cooking areas • **DE** Griddleplatte elektrische 1/2 gerillt + 1/2 glatt hartverchromt SUPERCHROME (Moca Approved), platte cm.59,5x45 - 2 Heizzonen • **FR** Plaque électriques 1/2 nervurée + 1/2 lisse chromée SUPERCHROME (Moca Approved), plaque cm.59,5x45 - 2 zones de cuisson • **ES** Fry-top eléctrico 1/2 estriado + 1/2 liso cromado SUPERCHROME (Moca Approved), plancha cm.59,5x45 - 2 zonas de cocción
cm. 60x 60x 28h

⚡ 6,75 kW **2.491,00**
400V~3N 66 / 0,28
230V~3
50/60 Hz



FRY-TOP ELETTRICI - TOP

MOD. _____
COD. _____

DESCRIZIONE/DESCRIPTION/BEZEICHNUNG/DESCRIPTION/DESCRIPCIÓN
DIMENSIONI/DIMENSIONS/ABMESSUNGEN/DIMENSIONS/DIMENSIONES

POTENZA/POWER/LEISTUNG/PUISSANCE/POTENCIA
VOLTAGGIO/VOLTAGE/SPANNUNG/VOLTAGE/VOLTAJE

⚡ kW kcal/h
⚡ kW V~ Hz

PREZZO/PRICE
PREIS/PRIX/PRECIO
KG / M³



FTRT-66ET
16060633

FRY-TOP ELETTRICO RIGATO, PIASTRA CM.59,5X45 - 2 ZONE DI COTTURA

EN Electric Fry-top grooved griddle, plate cm.59,5x45 - 2 cooking areas
• **DE** Griddleplatte elektrische gerillt, platte cm.59,5x45 - 2 Heizzonen
• **FR** Plaque électriques nervurée, plaque cm.59,5x45 - 2 zones de cuisson
• **ES** Fry-top eléctrico estriado, plancha cm.59,5x45 - 2 zonas de cocción
cm. 60x 60x 28h



⚡ 6,75 kW **2.050,00**
400V~3N 66 / 0,28
230V~3
50/60 Hz



FTRT-66ETS
16060636

FRY-TOP ELETTRICO RIGATO CROMATO SUPERCHROME (MOCA APPROVED), PIASTRA CM.59,5X45 - 2 ZONE DI COTTURA

EN Electric Fry-top grooved chromed griddle SUPERCHROME (Moca Approved), plate cm.59,5x45 - 2 cooking areas
• **DE** Griddleplatte elektrische gerillt hartverchromt SUPERCHROME (Moca Approved), platte cm.59,5x45 - 2 Heizzonen
• **FR** Plaque électriques nervurée chromée SUPERCHROME (Moca Approved), plaque cm.59,5x45 - 2 zones de cuisson
• **ES** Fry-top eléctrico estriado cromado SUPERCHROME (Moca Approved), plancha cm.59,5x45 - 2 zonas de cocción
cm. 60x 60x 28h

⚡ 6,75 kW **2.659,00**
400V~3N 66 / 0,28
230V~3
50/60 Hz



FTLT-68ET
16060831

FRY-TOP ELETTRICO LISCIO, PIASTRA CM.79,5X45 - 2 ZONE DI COTTURA

EN Electric Fry-top smooth griddle, plate cm.79,5x45 - 2 cooking areas
• **DE** Griddleplatte elektrische glatt, platte cm.79,5x45 - 2 Heizzonen
• **FR** Plaque électriques lisse, plaque cm.79,5x45 - 2 zones de cuisson
• **ES** Fry-top eléctrico liso, plancha cm.79,5x45 - 2 zonas de cocción
cm. 80x 60x 28h

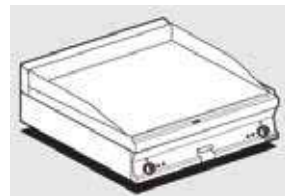

⚡ 9 kW **2.537,00**
400V~3N 81 / 0,37
230V~3
50/60 Hz

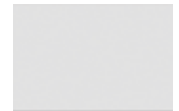

FTLT-68ETS
16060834

FRY-TOP ELETTRICO LISCIO CROMATO SUPERCHROME (MOCA APPROVED), PIASTRA CM.79,5X45 - 2 ZONE DI COTTURA

EN Electric Fry-top smooth chromed griddle SUPERCHROME (Moca Approved), plate cm.79,5x45 - 2 cooking areas
• **DE** Griddleplatte elektrische glatt hartverchromt SUPERCHROME (Moca Approved), platte cm.79,5x45 - 2 Heizzonen
• **FR** Plaque électriques lisse chromée SUPERCHROME (Moca Approved), plaque cm.79,5x45 - 2 zones de cuisson
• **ES** Fry-top eléctrico liso cromado SUPERCHROME (Moca Approved), plancha cm.79,5x45 - 2 zonas de cocción
cm. 80x 60x 28h

⚡ 9 kW **3.111,00**
400V~3N 81 / 0,37
230V~3
50/60 Hz

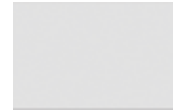

FTLT-68ETSS
16060830

FRY-TOP ELETTRICO LISCIO CROMO LUCIDO, PIASTRA CM.79,5X45 - 2 ZONE DI COTTURA

EN Electric Fry-top smooth POLISHED CHROME, plate cm.79,5x45 - 2 cooking areas
• **DE** Griddleplatte elektrische glatt POLIERTEM CHROM, platte cm.79,5x45 - 2 Heizzonen
• **FR** Plaque électriques lisse CHROME POLI, plaque cm.79,5x45 - 2 zones de cuisson
• **ES** Fry-top eléctrico liso CROMO PULIDO, plancha cm.79,5x45 - 2 zonas de cocción
cm. 80x 60x 28h

⚡ 9 kW **3.111,00**
400V~3N 81 / 0,37
230V~3
50/60 Hz

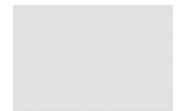

FRY-TOP ELETTRICI - TOP

MOD. _____
COD. _____

DESCRIZIONE/DESCRIPTION/BEZEICHNUNG/DESCRIPTION/DESCRIPCIÓN
DIMENSIONI/DIMENSIONS/ABMESSUNGEN/DIMENSIONS/DIMENSIONES

POTENZA/POWER/LEISTUNG/PUISSANCE/POTENCIA
VOLTAGGIO/VOLTAGE/SPANNUNG/VOLTAGE/VOLTAJE

⚡ kW kcal/h
⚡ kW V~ Hz

PREZZO/PRICE
PREIS/PRIX/PRECIO
KG / M³



FTLRT-68ET **FRY-TOP ELETTRICO 1/2 RIGATO + 1/2 LISCIO, PIASTRA**
16060832 **CM.79,5X45 - 2 ZONE DI COTTURA**
EN Electric Fry-top 1/2 grooved + 1/2 smooth, plate cm.79,5x45 - 2 cooking areas • **DE** Griddleplatte elektrische 1/2 gerillt + 1/2 glatt, platte cm.79,5x45 - 2 Heizzonen • **FR** Plaque électriques 1/2 nervurée + 1/2 lisse, plaque cm.79,5x45 - 2 zones de cuisson • **ES** Fry-top eléctrico 1/2 estriado + 1/2 liso, plancha cm.79,5x45 - 2 zonas de cocción
cm. 80x 60x 28h



⚡ 9 kW **2.699,00**
400V~3N 81 / 0,37
230V~3
50/60 Hz



FTLRT-68ETS **FRY-TOP ELETTRICO 1/2 RIGATO + 1/2 LISCIO CROMATO**
16060835 **SUPERCHROME (MOCA APPROVED), PIASTRA CM.79,5X45 - 2 ZONE DI COTTURA**
EN Electric Fry-top 1/2 grooved + 1/2 smooth chromed griddle SUPERCHROME (Moca Approved), plate cm.79,5x45 - 2 cooking areas • **DE** Griddleplatte elektrische 1/2 gerillt + 1/2 glatt hartverchromt SUPERCHROME (Moca Approved), platte cm.79,5x45 - 2 Heizzonen • **FR** Plaque électriques 1/2 nervurée + 1/2 lisse chromée SUPERCHROME (Moca Approved), plaque cm.79,5x45 - 2 zones de cuisson • **ES** Fry-top eléctrico 1/2 estriado + 1/2 liso cromado SUPERCHROME (Moca Approved), plancha cm.79,5x45 - 2 zonas de cocción
cm. 80x 60x 28h

⚡ 9 kW **3.273,00**
400V~3N 81 / 0,37
230V~3
50/60 Hz



FTRT-68ET **FRY-TOP ELETTRICO RIGATO, PIASTRA CM.79,5X45 - 2 ZONE**
16060833 **DI COTTURA**
EN Electric Fry-top grooved griddle, plate cm.79,5x45 - 2 cooking areas • **DE** Griddleplatte elektrische gerillt, platte cm.79,5x45 - 2 Heizzonen • **FR** Plaque électriques nervurée, plaque cm.79,5x45 - 2 zones de cuisson • **ES** Fry-top eléctrico estriado, plancha cm.79,5x45 - 2 zonas de cocción
cm. 80x 60x 28h



⚡ 9 kW **2.858,00**
400V~3N 81 / 0,37
230V~3
50/60 Hz



FTRT-68ETS **FRY-TOP ELETTRICO RIGATO CROMATO SUPERCHROME**
16060836 **(MOCA APPROVED), PIASTRA CM.79,5X45 - 2 ZONE DI COTTURA**
EN Electric Fry-top grooved chromed griddle SUPERCHROME (Moca Approved), plate cm.79,5x45 - 2 cooking areas • **DE** Griddleplatte elektrische gerillt hartverchromt SUPERCHROME (Moca Approved), platte cm.79,5x45 - 2 Heizzonen • **FR** Plaque électriques nervurée chromée SUPERCHROME (Moca Approved), plaque cm.79,5x45 - 2 zones de cuisson • **ES** Fry-top eléctrico estriado cromado SUPERCHROME (Moca Approved), plancha cm.79,5x45 - 2 zonas de cocción
cm. 80x 60x 28h

⚡ 9 kW **3.437,00**
400V~3N 81 / 0,37
230V~3
50/60 Hz



FTLT-610ET **FRY-TOP ELETTRICO LISCIO, PIASTRA CM.99,5X45 - 2 ZONE**
16061031 **DI COTTURA**
EN Electric Fry-top smooth griddle, plate cm.99,5x45 - 2 cooking areas • **DE** Griddleplatte elektrische glatt, platte cm.99,5x45 - 2 Heizzonen • **FR** Plaque électriques lisse, plaque cm.99,5x45 - 2 zones de cuisson • **ES** Fry-top eléctrico liso, plancha cm.99,5x45 - 2 zonas de cocción
cm. 100x 60x 28h



⚡ 11,25 kW **2.887,00**
400V~3N 88 / 0,46
50/60 Hz



FTLT-610ETS **FRY-TOP ELETTRICO LISCIO CROMATO SUPERCHROME (MOCA**
16061034 **APPROVED), PIASTRA CM.99,5X45 - 2 ZONE DI COTTURA**
EN Electric Fry-top smooth chromed griddle SUPERCHROME (Moca Approved), plate cm.99,5x45 - 2 cooking areas • **DE** Griddleplatte elektrische glatt hartverchromt SUPERCHROME (Moca Approved), platte cm.99,5x45 - 2 Heizzonen • **FR** Plaque électriques lisse chromée SUPERCHROME (Moca Approved), plaque cm.99,5x45 - 2 zones de cuisson • **ES** Fry-top eléctrico liso cromado SUPERCHROME (Moca Approved), plancha cm.99,5x45 - 2 zonas de cocción
cm. 100x 60x 28h

⚡ 11,25 kW **3.438,00**
400V~3N 88 / 0,46
50/60 Hz



FRY-TOP ELETTRICI - TOP

MOD. _____
COD. _____

DESCRIZIONE/DESCRIPTION/BEZEICHNUNG/DESCRIPTION/DESCRIPCIÓN
DIMENSIONI/DIMENSIONS/ABMESSUNGEN/DIMENSIONS/DIMENSIONES

POTENZA/POWER/LEISTUNG/PUISSANCE/POTENCIA
VOLTAGGIO/VOLTAGE/SPANNUNG/VOLTAGE/VOLTAJE

⚡ 11,25 kW
400V~3N
50/60 Hz

PREZZO/PRICE
PREIS/PRIX/PRECIO
KG / M³



FTLT-610ETSS FRY-TOP ELETTRICO LISCIO CROMO LUCIDO, PIASTRA

16061030

CM.99,5X45 - 2 ZONE DI COTTURA

EN Electric Fry-top smooth POLISHED CHROME, plate cm.99,5x45 - 2 cooking areas • **DE** Griddleplatte elektrische glatt POLIERTEM CHROM, platte cm.99,5x45 - 2 Heizzonen • **FR** Plaque électriques lisse CHROME POLI, plaque cm.99,5x45 - 2 zones de cuisson • **ES** Fry-top eléctrico liso CROMO PULIDO, plancha cm.99,5x45 - 2 zonas de cocción
cm. 100x 60x 28h



⚡ 11,25 kW **3.438,00**
400V~3N 88 / 0,46
50/60 Hz

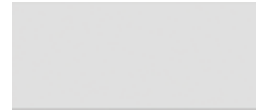

FTLRT-610ET FRY-TOP ELETTRICO 2/5 RIGATO + 3/5 LISCIO, PIASTRA

16061032

CM.99,5X45 - 2 ZONE DI COTTURA

EN Electric Fry-top 2/5 grooved + 3/5 smooth, plate cm.99,5x45 - 2 cooking areas • **DE** Griddleplatte elektrische 2/5 gerillt + 3/5 glatt, platte cm.99,5x45 - 2 Heizzonen • **FR** Plaque électriques 2/5 nervurée + 3/5 lisse, plaque cm.99,5x45 - 2 zones de cuisson • **ES** Fry-top eléctrico 2/5 estriado + 3/5 liso, plancha cm.99,5x45 - 2 zonas de cocción
cm. 100x 60x 28h



⚡ 11,25 kW **3.062,00**
400V~3N 88 / 0,46
50/60 Hz



FTLRT-610ETS FRY-TOP ELETTRICO 2/5 RIGATO + 3/5 LISCIO CROMATO SUPERCHROME (MOCA APPROVED), PIASTRA CM.99,5X45 - 2 ZONE DI COTTURA

16061035

EN Electric Fry-top 2/5 grooved + 3/5 smooth chromed griddle SUPERCHROME (Moca Approved), plate cm.99,5x45 - 2 cooking areas • **DE** Griddleplatte elektrische 2/5 gerillt + 3/5 glatt hartverchromt SUPERCHROME (Moca Approved), platte cm.99,5x45 - 2 Heizzonen • **FR** Plaque électriques 2/5 nervurée + 3/5 lisse chromée SUPERCHROME (Moca Approved), plaque cm.99,5x45 - 2 zones de cuisson • **ES** Fry-top eléctrico 2/5 estriado + 3/5 liso cromado SUPERCHROME (Moca Approved), plancha cm.99,5x45 - 2 zonas de cocción
cm. 100x 60x 28h

⚡ 11,25 kW **3.600,00**
400V~3N 88 / 0,46
50/60 Hz



FTRT-610ET FRY-TOP ELETTRICO RIGATO, PIASTRA CM.99,5X45 - 2 ZONE DI COTTURA

16061033

EN Electric Fry-top grooved griddle, plate cm.99,5x45 - 2 cooking areas • **DE** Griddleplatte elektrische gerillt, platte cm.99,5x45 - 2 Heizzonen • **FR** Plaque électriques nervurée, plaque cm.99,5x45 - 2 zones de cuisson • **ES** Fry-top eléctrico estriado, plancha cm.99,5x45 - 2 zonas de cocción
cm. 100x 60x 28h



⚡ 11,25 kW **3.235,00**
400V~3N 88 / 0,46
50/60 Hz



FTRT-610ETS FRY-TOP ELETTRICO RIGATO CROMATO SUPERCHROME (MOCA APPROVED), PIASTRA CM.99,5X45 - 2 ZONE DI COTTURA

16061036

EN Electric Fry-top grooved chromed griddle SUPERCHROME (Moca Approved), plate cm.99,5x45 - 2 cooking areas • **DE** Griddleplatte elektrische gerillt hartverchromt SUPERCHROME (Moca Approved), platte cm.99,5x45 - 2 Heizzonen • **FR** Plaque électriques nervurée chromée SUPERCHROME (Moca Approved), plaque cm.99,5x45 - 2 zones de cuisson • **ES** Fry-top eléctrico estriado cromado SUPERCHROME (Moca Approved), plancha cm.99,5x45 - 2 zonas de cocción
cm. 100x 60x 28h

⚡ 11,25 kW **3.778,00**
400V~3N 88 / 0,46
50/60 Hz



FRY-TOP A GAS - TOP

MOD. _____
COD. _____

DESCRIZIONE/DESCRIPTION/BEZEICHNUNG/DESCRIPTION/DESCRIPCIÓN
DIMENSIONI/DIMENSIONS/ABMESSUNGEN/DIMENSIONS/DIMENSIONES

POTENZA/POWER/LEISTUNG/PUISSANCE/POTENCIA
VOLTAGGIO/VOLTAGE/SPANNUNG/VOLTAGE/VOLTAJE

6 kW
5.160 kcal/h

PREZZO/PRICE
PREIS/PRIX/PRECIO
KG / M³



FTLT-64G
16230451

FRY-TOP GAS LISCIO, PIASTRA CM.39,5X45
EN Gas Fry-top smooth griddle, plate cm.39,5x45 • **DE** Gas-griddleplatte glatt, platte cm.39,5x45 • **FR** Plaque gaz lisse, plaque cm.39,5x45 • **ES** Fry-top gas liso, plancha cm.39,5x45
cm. 40x 60x 28h



6 kW
5.160 kcal/h

1.385,00
47 / 0,19

FTLT-64GS
16230454

FRY-TOP GAS LISCIO CROMATO SUPERCHROME (MOCA APPROVED), PIASTRA CM.39,5X45
EN Gas Fry-top smooth chromed griddle SUPERCHROME (Moca Approved), plate cm.39,5x45 • **DE** Gas-griddleplatte glatt hartverchromt SUPERCHROME (Moca Approved), platte cm.39,5x45 • **FR** Plaque gaz lisse chromée SUPERCHROME (Moca Approved), plaque cm.39,5x45 • **ES** Fry-top gas liso cromado SUPERCHROME (Moca Approved), plancha cm.39,5x45
cm. 40x 60x 28h

6 kW
5.160 kcal/h

1.839,00
47 / 0,19

FTLT-64GSS
16230450

FRY-TOP GAS LISCIO CROMO LUCIDO, PIASTRA CM.39,5X45
EN Gas Fry-top smooth POLISHED CHROME, plate cm.39,5x45 • **DE** Gas-griddleplatte glatt POLIERTEM CHROM, platte cm.39,5x45 • **FR** Plaque gaz lisse CHROME POLI, plaque cm.39,5x45 • **ES** Fry-top gas liso CROMO PULIDO, plancha cm.39,5x45
cm. 40x 60x 28h

6 kW
5.160 kcal/h

1.839,00
47 / 0,19

FVRT-64G
16230453

FRY-TOP GAS RIGATO, PIASTRA CM.39,5X45
EN Gas Fry-top grooved griddle, plate cm.39,5x45 • **DE** Gas-griddleplatte gerillt, platte cm.39,5x45 • **FR** Plaque gaz nervurée, plaque cm.39,5x45 • **ES** Fry-top gas estriado, plancha cm.39,5x45
cm. 40x 60x 28h

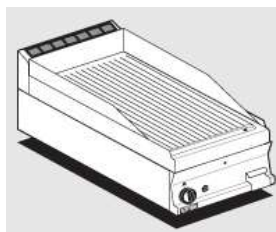

6 kW
5.160 kcal/h

1.514,00
47 / 0,19

FVRT-64GS
16230456

FRY-TOP GAS RIGATO CROMATO SUPERCHROME (MOCA APPROVED), PIASTRA CM.39,5X45
EN Gas Fry-top grooved chromed griddle SUPERCHROME (Moca Approved), plate cm.39,5x45 • **DE** Gas-griddleplatte gerillt hartverchromt SUPERCHROME (Moca Approved), platte cm.39,5x45 • **FR** Plaque gaz nervurée chromée SUPERCHROME (Moca Approved), plaque cm.39,5x45 • **ES** Fry-top gas estriado cromado SUPERCHROME (Moca Approved), plancha cm.39,5x45
cm. 40x 60x 28h

6 kW
5.160 kcal/h

2.028,00
47 / 0,19

FTLT-66G
16230651

FRY-TOP GAS LISCIO, PIASTRA CM.59,5X45 - 2 ZONE DI COTTURA
EN Gas Fry-top smooth griddle, plate cm.59,5x45 - 2 cooking areas • **DE** Gas-griddleplatte glatt, platte cm.59,5x45 - 2 Heizzonen • **FR** Plaque gaz lisse, plaque cm.59,5x45 - 2 zones de cuisson • **ES** Fry-top gas liso, plancha cm.59,5x45 - 2 zonas de cocción
cm. 60x 60x 28h



9 kW
7.740 kcal/h

1.973,00
65 / 0,28

FTLT-66GS
16230654

FRY-TOP GAS LISCIO CROMATO SUPERCHROME (MOCA APPROVED), PIASTRA CM.59,5X45 - 2 ZONE DI COTTURA
EN Gas Fry-top smooth chromed griddle SUPERCHROME (Moca Approved), plate cm.59,5x45 - 2 cooking areas • **DE** Gas-griddleplatte glatt hartverchromt SUPERCHROME (Moca Approved), platte cm.59,5x45 - 2 Heizzonen • **FR** Plaque gaz lisse chromée SUPERCHROME (Moca Approved), plaque cm.59,5x45 - 2 zones de cuisson • **ES** Fry-top gas liso cromado SUPERCHROME (Moca Approved), plancha cm.59,5x45 - 2 zonas de cocción
cm. 60x 60x 28h

9 kW
7.740 kcal/h

2.375,00
65 / 0,28

FTLT-66GSS
16230650

FRY-TOP GAS LISCIO CROMO LUCIDO, PIASTRA CM.59,5X45 - 2 ZONE DI COTTURA
EN Gas Fry-top smooth POLISHED CHROME, plate cm.59,5x45 - 2 cooking areas • **DE** Gas-griddleplatte glatt POLIERTEM CHROM, platte cm.59,5x45 - 2 Heizzonen • **FR** Plaque gaz lisse CHROME POLI, plaque cm.59,5x45 - 2 zones de cuisson • **ES** Fry-top gas liso CROMO PULIDO, plancha cm.59,5x45 - 2 zonas de cocción
cm. 60x 60x 28h

9 kW
7.740 kcal/h

2.375,00
65 / 0,28

FRY-TOP A GAS - TOP

MOD. _____
COD. _____

DESCRIZIONE/DESCRIPTION/BEZEICHNUNG/DESCRIPTION/DESCRIPCIÓN
DIMENSIONI/DIMENSIONS/ABMESSUNGEN/DIMENSIONS/DIMENSIONES

POTENZA/POWER/LEISTUNG/PUISSANCE/POTENCIA
VOLTAGGIO/VOLTAGE/SPANNUNG/VOLTAGE/VOLTAJE

9 kW
7.740 kcal/h

PREZZO/PRICE
PREIS/PRIX/PRECIO
KG / M³



FTLRT-66G
16230652

FRY-TOP GAS 1/2 RIGATO + 1/2 LISCIO, PIASTRA CM.59,5X45 - 2 ZONE DI COTTURA

EN Gas Fry-top 1/2 grooved + 1/2 smooth, plate cm.59,5x45 - 2 cooking areas • **DE** Gas-griddleplatte 1/2 gerillt + 1/2 glatt, platte cm.59,5x45 - 2 Heizzonen • **FR** Plaque gaz 1/2 nervurée + 1/2 lisse, plaque cm.59,5x45 - 2 zones de cuisson • **ES** Fry-top gas 1/2 estriado + 1/2 liso, plancha cm.59,5x45 - 2 zonas de cocción
cm. 60x 60x 28h



9 kW
7.740 kcal/h

2.120,00
65 / 0,28

FTLRT-66GS
16230655

FRY-TOP GAS 1/2 RIGATO + 1/2 LISCIO CROMATO SUPERCHROME (MOCA APPROVED), PIASTRA CM.59,5X45 - 2 ZONE DI COTTURA

EN Gas Fry-top 1/2 grooved + 1/2 smooth chromed griddle SUPERCHROME (Moca Approved), plate cm.59,5x45 - 2 cooking areas • **DE** Gas-griddleplatte 1/2 gerillt + 1/2 glatt hartverchromt SUPERCHROME (Moca Approved), platte cm.59,5x45 - 2 Heizzonen • **FR** Plaque gaz 1/2 nervurée + 1/2 lisse chromée SUPERCHROME (Moca Approved), plaque cm.59,5x45 - 2 zones de cuisson • **ES** Fry-top gas 1/2 estriado + 1/2 liso cromado SUPERCHROME (Moca Approved), plancha cm.59,5x45 - 2 zonas de cocción
cm. 60x 60x 28h

9 kW
7.740 kcal/h

2.431,00
65 / 0,28

FTRT-66G
16230653

FRY-TOP GAS RIGATO, PIASTRA CM.59,5X45 - 2 ZONE DI COTTURA

EN Gas Fry-top grooved griddle, plate cm.59,5x45 - 2 cooking areas • **DE** Gas-griddleplatte gerillt, platte cm.59,5x45 - 2 Heizzonen • **FR** Plaque gaz nervurée, plaque cm.59,5x45 - 2 zones de cuisson • **ES** Fry-top gas estriado, plancha cm.59,5x45 - 2 zonas de cocción
cm. 60x 60x 28h



9 kW
7.740 kcal/h

2.268,00
65 / 0,28

FTRT-66GS
16230656

FRY-TOP GAS RIGATO CROMATO SUPERCHROME (MOCA APPROVED), PIASTRA CM.59,5X45 - 2 ZONE DI COTTURA

EN Gas Fry-top grooved chromed griddle SUPERCHROME (Moca Approved), plate cm.59,5x45 - 2 cooking areas • **DE** Gas-griddleplatte gerillt hartverchromt SUPERCHROME (Moca Approved), platte cm.59,5x45 - 2 Heizzonen • **FR** Plaque gaz nervurée chromée SUPERCHROME (Moca Approved), plaque cm.59,5x45 - 2 zones de cuisson • **ES** Fry-top gas estriado cromado SUPERCHROME (Moca Approved), plancha cm.59,5x45 - 2 zonas de cocción
cm. 60x 60x 28h

9 kW
7.740 kcal/h

2.549,00
65 / 0,28

FTLT-68G
16230851

FRY-TOP GAS LISCIO, PIASTRA CM.79,5X45 - 2 ZONE DI COTTURA

EN Gas Fry-top smooth griddle, plate cm.79,5x45 - 2 cooking areas • **DE** Gas-griddleplatte glatt, platte cm.79,5x45 - 2 Heizzonen • **FR** Plaque gaz lisse, plaque cm.79,5x45 - 2 zones de cuisson • **ES** Fry-top gas liso, plancha cm.79,5x45 - 2 zonas de cocción
cm. 80x 60x 28h

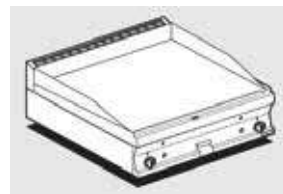

12 kW
10.320 kcal/h

2.728,00
83 / 0,37

FTLT-68GS
16230854

FRY-TOP GAS LISCIO CROMATO SUPERCHROME (MOCA APPROVED), PIASTRA CM.79,5X45 - 2 ZONE DI COTTURA

EN Gas Fry-top smooth chromed griddle SUPERCHROME (Moca Approved), plate cm.79,5x45 - 2 cooking areas • **DE** Gas-griddleplatte glatt hartverchromt SUPERCHROME (Moca Approved), platte cm.79,5x45 - 2 Heizzonen • **FR** Plaque gaz lisse chromée SUPERCHROME (Moca Approved), plaque cm.79,5x45 - 2 zones de cuisson • **ES** Fry-top gas liso cromado SUPERCHROME (Moca Approved), plancha cm.79,5x45 - 2 zonas de cocción
cm. 80x 60x 28h

12 kW
10.320 kcal/h

3.243,00
83 / 0,37

FTLT-68GSS
16230850

FRY-TOP GAS LISCIO CROMO LUCIDO, PIASTRA CM.79,5X45 - 2 ZONE DI COTTURA

EN Gas Fry-top smooth POLISHED CHROME, plate cm.79,5x45 - 2 cooking areas • **DE** Gas-griddleplatte glatt POLIERTEM CHROM, platte cm.79,5x45 - 2 Heizzonen • **FR** Plaque gaz lisse CHROME POLI, plaque cm.79,5x45 - 2 zones de cuisson • **ES** Fry-top gas liso CROMO PULIDO, plancha cm.79,5x45 - 2 zonas de cocción
cm. 80x 60x 28h

12 kW
10.320 kcal/h

3.243,00
83 / 0,37

FRY-TOP A GAS - TOP

MOD. _____
COD. _____

DESCRIZIONE/DESCRIPTION/BEZEICHNUNG/DESCRIPTION/DESCRIPCIÓN
DIMENSIONI/DIMENSIONS/ABMESSUNGEN/DIMENSIONS/DIMENSIONES

POTENZA/POWER/LEISTUNG/PUISSANCE/POTENCIA
VOLTAGGIO/VOLTAGE/SPANNUNG/VOLTAGE/VOLTAJE

12 kW
10.320 kcal/h

PREZZO/PRICE
PREIS/PRIX/PRECIO
KG / M³



FTLRT-68G
16230852

FRY-TOP GAS 1/2 RIGATO + 1/2 LISCIO, PIASTRA CM.79,5X45 - 2 ZONE DI COTTURA

EN Gas Fry-top 1/2 grooved + 1/2 smooth, plate cm.79,5x45 - 2 cooking areas • **DE** Gas-griddleplatte 1/2 gerillt + 1/2 glatt, platte cm.79,5x45 - 2 Heizzonen • **FR** Plaque gaz 1/2 nervurée + 1/2 lisse, plaque cm.79,5x45 - 2 zones de cuisson • **ES** Fry-top gas 1/2 estriado + 1/2 liso, plancha cm.79,5x45 - 2 zonas de cocción
cm. 80x 60x 28h



12 kW
10.320 kcal/h

2.827,00
83 / 0,37

FTLRT-68GS
16230855

FRY-TOP GAS 1/2 RIGATO + 1/2 LISCIO CROMATO SUPERCHROME (MOCA APPROVED), PIASTRA CM.79,5X45 - 2 ZONE DI COTTURA

EN Gas Fry-top 1/2 grooved + 1/2 smooth chromed griddle SUPERCHROME (Moca Approved), plate cm.79,5x45 - 2 cooking areas • **DE** Gas-griddleplatte 1/2 gerillt + 1/2 glatt hartverchromt SUPERCHROME (Moca Approved), platte cm.79,5x45 - 2 Heizzonen • **FR** Plaque gaz 1/2 nervurée + 1/2 lisse chromée SUPERCHROME (Moca Approved), plaque cm.79,5x45 - 2 zones de cuisson • **ES** Fry-top gas 1/2 estriado + 1/2 liso cromado SUPERCHROME (Moca Approved), plancha cm.79,5x45 - 2 zonas de cocción
cm. 80x 60x 28h

12 kW
10.320 kcal/h

3.321,00
83 / 0,37

FTRT-68G
16230853

FRY-TOP GAS RIGATO, PIASTRA CM.79,5X45 - 2 ZONE DI COTTURA

EN Gas Fry-top grooved griddle, plate cm.79,5x45 - 2 cooking areas • **DE** Gas-griddleplatte gerillt, platte cm.79,5x45 - 2 Heizzonen • **FR** Plaque gaz nervurée, plaque cm.79,5x45 - 2 zones de cuisson • **ES** Fry-top gas estriado, plancha cm.79,5x45 - 2 zonas de cocción
cm. 80x 60x 28h

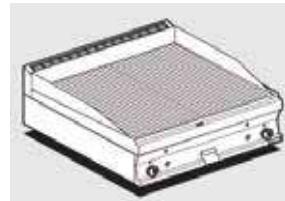

12 kW
10.320 kcal/h

3.007,00
83 / 0,37

FTRT-68GS
16230856

FRY-TOP GAS RIGATO CROMATO SUPERCHROME (MOCA APPROVED), PIASTRA CM.79,5X45 - 2 ZONE DI COTTURA

EN Gas Fry-top grooved chromed griddle SUPERCHROME (Moca Approved), plate cm.79,5x45 - 2 cooking areas • **DE** Gas-griddleplatte gerillt hartverchromt SUPERCHROME (Moca Approved), platte cm.79,5x45 - 2 Heizzonen • **FR** Plaque gaz nervurée chromée SUPERCHROME (Moca Approved), plaque cm.79,5x45 - 2 zones de cuisson • **ES** Fry-top gas estriado cromado SUPERCHROME (Moca Approved), plancha cm.79,5x45 - 2 zonas de cocción
cm. 80x 60x 28h

12 kW
10.320 kcal/h

3.499,00
83 / 0,37

FTLT-610G
16231051

FRY-TOP GAS LISCIO, PIASTRA CM.99,5X45 - 2 ZONE DI COTTURA

EN Gas Fry-top smooth griddle, plate cm.99,5x45 - 2 cooking areas • **DE** Gas-griddleplatte glatt, platte cm.99,5x45 - 2 Heizzonen • **FR** Plaque gaz lisse, plaque cm.99,5x45 - 2 zones de cuisson • **ES** Fry-top gas liso, plancha cm.99,5x45 - 2 zonas de cocción
cm. 100x 60x 28h



15 kW
12.900 kcal/h

3.122,00
89 / 0,46

FTLT-610GS
16231054

FRY-TOP GAS LISCIO CROMATO SUPERCHROME (MOCA APPROVED), PIASTRA CM.99,5X45 - 2 ZONE DI COTTURA

EN Gas Fry-top smooth chromed griddle SUPERCHROME (Moca Approved), plate cm.99,5x45 - 2 cooking areas • **DE** Gas-griddleplatte glatt hartverchromt SUPERCHROME (Moca Approved), platte cm.99,5x45 - 2 Heizzonen • **FR** Plaque gaz lisse chromée SUPERCHROME (Moca Approved), plaque cm.99,5x45 - 2 zones de cuisson • **ES** Fry-top gas liso cromado SUPERCHROME (Moca Approved), plancha cm.99,5x45 - 2 zonas de cocción
cm. 100x 60x 28h

15 kW
12.900 kcal/h

3.640,00
89 / 0,46

FTLT-610GSS
16231050

FRY-TOP GAS LISCIO CROMO LUCIDO, PIASTRA CM.99,5X45 - 2 ZONE DI COTTURA

EN Gas Fry-top smooth POLISHED CHROME, plate cm.99,5x45 - 2 cooking areas • **DE** Gas-griddleplatte glatt POLIERTEM CHROM, platte cm.99,5x45 - 2 Heizzonen • **FR** Plaque gaz lisse CHROME POLI, plaque cm.99,5x45 - 2 zones de cuisson • **ES** Fry-top gas liso CROMO PULIDO, plancha cm.99,5x45 - 2 zonas de cocción
cm. 100x 60x 28h

15 kW
12.900 kcal/h

3.640,00
89 / 0,46

FRY-TOP A GAS - TOP

MOD. _____
COD. _____

DESCRIZIONE/DESCRIPTION/BEZEICHNUNG/DESCRIPTION/DESCRIPCIÓN
DIMENSIONI/DIMENSIONS/ABMESSUNGEN/DIMENSIONS/DIMENSIONES

POTENZA/POWER/LEISTUNG/PUISSANCE/POTENCIA
VOLTAGGIO/VOLTAGE/SPANNUNG/VOLTAGE/VOLTAJE

⚡ $\frac{15 \text{ kW}}{12.900 \text{ kcal/h}}$
 $\frac{15 \text{ kW}}{12.900 \text{ kcal/h}}$

PREZZO/PRICE
PREIS/PRIX/PRECIO
KG / M³



FTLRT-610G FRY-TOP GAS 2/5 RIGATO + 3/5 LISCIO, PIASTRA
16231052 **CM.99,5X45 - 2 ZONE DI COTTURA**

EN Gas Fry-top 2/5 grooved + 3/5 smooth, plate cm.99,5x45 - 2 cooking areas • **DE** Gas-griddleplatte 2/5 gerillt + 3/5 glatt, platte cm.99,5x45 - 2 Heizzonen • **FR** Plaque gaz 2/5 nervurée + 3/5 lisse, plaque cm.99,5x45 - 2 zones de cuisson • **ES** Fry-top gas 2/5 estriado + 3/5 liso, plancha cm.99,5x45 - 2 zonas de cocción
cm. 100x 60x 28h



⚡ $\frac{15 \text{ kW}}{12.900 \text{ kcal/h}}$ **3.291,00**
89 / 0,46



FTLRT-610GS FRY-TOP GAS 2/5 RIGATO + 3/5 LISCIO CROMATO
16231055 **SUPERCHROME (MOCA APPROVED), PIASTRA CM.99,5X45 - 2 ZONE DI COTTURA**

EN Gas Fry-top 2/5 grooved + 3/5 smooth chromed griddle SUPERCHROME (Moca Approved), plate cm.99,5x45 - 2 cooking areas • **DE** Gas-griddleplatte 2/5 gerillt + 3/5 glatt hartverchromt SUPERCHROME (Moca Approved), platte cm.99,5x45 - 2 Heizzonen • **FR** Plaque gaz 2/5 nervurée + 3/5 lisse chromée SUPERCHROME (Moca Approved), plaque cm.99,5x45 - 2 zones de cuisson • **ES** Fry-top gas 2/5 estriado + 3/5 liso cromado SUPERCHROME (Moca Approved), plancha cm.99,5x45 - 2 zonas de cocción
cm. 100x 60x 28h

⚡ $\frac{15 \text{ kW}}{12.900 \text{ kcal/h}}$ **3.798,00**
89 / 0,46



FTRT-610G FRY-TOP GAS RIGATO, PIASTRA CM.99,5X45 - 2 ZONE DI
16231053 **COTTURA**

EN Gas Fry-top grooved griddle, plate cm.99,5x45 - 2 cooking areas • **DE** Gas-griddleplatte gerillt, platte cm.99,5x45 - 2 Heizzonen • **FR** Plaque gaz nervurée, plaque cm.99,5x45 - 2 zones de cuisson • **ES** Fry-top gas estriado, plancha cm.99,5x45 - 2 zonas de cocción
cm. 100x 60x 28h



⚡ $\frac{15 \text{ kW}}{12.900 \text{ kcal/h}}$ **3.594,00**
89 / 0,46



FTRT-610GS FRY-TOP GAS RIGATO CROMATO SUPERCHROME (MOCA
16231056 **APPROVED), PIASTRA CM.99,5X45 - 2 ZONE DI COTTURA**

EN Gas Fry-top grooved chromed griddle SUPERCHROME (Moca Approved), plate cm.99,5x45 - 2 cooking areas • **DE** Gas-griddleplatte gerillt hartverchromt SUPERCHROME (Moca Approved), platte cm.99,5x45 - 2 Heizzonen • **FR** Plaque gaz nervurée chromée SUPERCHROME (Moca Approved), plaque cm.99,5x45 - 2 zones de cuisson • **ES** Fry-top gas estriado cromado SUPERCHROME (Moca Approved), plancha cm.99,5x45 - 2 zonas de cocción
cm. 100x 60x 28h

⚡ $\frac{15 \text{ kW}}{12.900 \text{ kcal/h}}$ **3.957,00**
89 / 0,46



RSFT-63EM PIASTRA PER SANDWICH SOPRA FRYTOP ELETTRICI
16630317 **- PIASTRA CM. 29X40 (ATTENZIONE: PROFONDITA' MACCHINA +CM.10)**

EN Sandwiches plate above electric griddle - plate cm. 29x40 (ATTENTION: DEPTH MACHINE +cm.10) • **DE** Sandwiches Platte über Elektrische Griddle - platte cm. 29x40 (VORSICHT: TIEFE MACHINE +cm.10) • **FR** Plaque pour sandwichs au-dessus électrique fry-top - plaque cm. 29x40 (ATTENTION: PROFONDEUR MACHINE +cm.10) • **ES** Plancia para sándwiches sobre fry-top eléctrico - plancia cm. 29x40 (ATENCIÓN: PROFUNDIDAD MÁQUINA +cm.10)
cm. 32x 61x 41h



⚡ $\frac{2,9 \text{ KW}}{230V\sim}$ **1.329,00**
 $\frac{230V\sim}{50/60 \text{ Hz}}$ 20 / 0,21

PCT-63ET PIANO COTTURA TRIFASE N. 2 PIASTRE
16030330

EN Boiling unit - N. 2 plates • **DE** Kochplatte - N. 2 Kochplatten • **FR** Rechaud - N. 2 plaques • **ES** Sobre de cocción - N. 2 planchas
cm. 30x 60x 28h



⚡ $\frac{3 \text{ kW}}{400V\sim 2N}$ **801,00**
 $\frac{230V\sim 3}{230V\sim}$ 16 / 0,15
 $\frac{50/60 \text{ Hz}}$



PIANI COTTURA ELETTRICI - TOP

MOD. _____
COD. _____

DESCRIZIONE/DESCRIPTION/BEZEICHNUNG/DESCRIPTION/DESCRIPCIÓN
DIMENSIONI/DIMENSIONS/ABMESSUNGEN/DIMENSIONS/DIMENSIONES

POTENZA/POWER/LEISTUNG/PUISSANCE/POTENCIA
VOLTAGGIO/VOLTAGE/SPANNUNG/VOLTAGE/VOLTAJE

⚡ kW _____
kcal/h _____
V~ _____
Hz _____

PREZZO/PRICE
PREIS/PRIX/PRECIO
KG / M³



PCT-66ET
16030630

PIANO COTTURA TRIFASE N. 4 PIASTRE
EN Boiling unit - N. 4 plates • **DE** Kochplatte - N. 4 Kochplatten • **FR** Rechaud - N. 4 plaques • **ES** Sobre de cocción - N. 4 planchas
cm. 60x 60x 28h



⚡ 6 kW _____ **1.289,00**
400V~3N _____ 27 / 0,28
230V~3
230V~
50/60 Hz

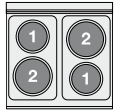

PCCT-63ET
16030332

PIANO COTTURA VETROCERAMICA TRIFASE - N. 2 ZONE - VETRO CM.25X47
EN Ceramic glass boiling unit - n. 2 zones - glass cm.25x47 • **DE** Ceran-Kochplatte dreiphasig - 2 zonen - Glas 25x47 cm • **FR** Plan de cuisson à vitrocéramique triphasé N. 2 zones - Verre cm.25x47 • **ES** Sobre de cocción trifásico vitrocerámica - 2 zonas - vidrio cm.35x57
cm. 30x 60x 28h



⚡ 3 kW _____ **1.786,00**
400V~2N _____ 19 / 0,15
230V~3
230V~
50/60 Hz

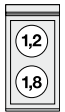

PCCT-66ET
16030632

PIANO COTTURA VETROCERAMICA TRIFASE - N. 4 ZONE - VETRO CM.55X47
EN Ceramic glass boiling unit - n. 4 zones - glass cm.55x47 • **DE** Ceran-Kochplatte dreiphasig - 4 zonen - Glas 55x47 cm • **FR** Plan de cuisson à vitrocéramique triphasé N. 4 zones - Verre cm.55x47 • **ES** Sobre de cocción trifásico vitrocerámica - 2 zonas - vidrio cm.35x57
cm. 60x 60x 28h



⚡ 6 kW _____ **3.047,00**
400V~3N _____ 26 / 0,28
230V~3
230V~
50/60 Hz

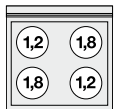

PCIT-64ET
16030433

PIANI COTTURA A INDUZIONE TRIFASE - VETRO CM 35X47 (NON POSIZIONARE SU FORNI O CASSETTIERE)
EN Three-phase induction cooking top - Plates cm 35x47 (do not place on ovens or drawers) • **DE** Induktions-Kochplatte dreiphasig cm 35x47 (nicht Platz auf Öfen oder Schubladen) • **FR** Plan de cuisson à induction triphasé - Verre cm. 35x47 (ne placez pas sur des fours ou des tiroirs) • **ES** Encimera inducción trifásica - Vidrio cm. 35x47 (No coloque en los hornos o en los cajones)
cm. 40x 60x 28h



⚡ 5 kW _____ **4.974,00**
400V~3 _____ 23 / 0,19
50/60 Hz

PIANI COTTURA A INDUZIONE - TOP

MOD. _____
COD. _____

DESCRIZIONE/DESCRIPTION/BEZEICHNUNG/DESCRIPTION/DESCRIPCIÓN
DIMENSIONI/DIMENSIONS/ABMESSUNGEN/DIMENSIONS/DIMENSIONES

POTENZA/POWER/LEISTUNG/PUISSANCE/POTENCIA
VOLTAGGIO/VOLTAGE/SPANNUNG/VOLTAGE/VOLTAJE

⚡ kW kcal/h
⚡ kw kcal/h
V~ Hz

PREZZO/PRICE
PREIS/PRIX/PRECIO
KG / M³



PCIWT-64ET PIANI COTTURA A INDUZIONE WOK 1 PIASTRA INDUZIONE
16030434 - VETRO Ø 30 CM (NON POSIZIONARE SU FORNI O CASSETTIERE)

EN Three-phase wok induction cooking top 1 glass induction plates Ø 30 cm (do not place on ovens or drawers) • **DE** Induktions-Kochplatte dreiphasig Wok 1 Glasinduktionsplatten Ø 30 cm (nicht Platz auf Öfen oder Schubladen) • **FR** Plan de cuisson à induction triphasé wok 1 plaques à induction - Verre Ø 30 cm (ne placez pas sur des fours ou des tiroirs) • **ES** Encimera inducción trifásica wok 1 placas inducción - Vidrio Ø 30 cm (No coloque en los hornos o en los cajones)
cm. 40x 60x 28h



⚡ 5 kW 5.154,00
400V~3 23 / 0,19
50/60 Hz

PCT-63G PIANO COTTURA A GAS, 2 FUOCHI
16210350 **EN** Gas heated boiling - 2 burners • **DE** Gas-Kochplatte - 2 Kochstellen
• **FR** Rechaud gaz - 2 feux vifs • **ES** Sobres de cocción gas - 2 quemadores
cm. 30x 60x 28h



⚡ 9 kW 1.145,00
7.740 kcal/h 20 / 0,15

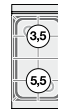

PCT-66G PIANO COTTURA A GAS, 4 FUOCHI
16210650 **EN** Gas heated boiling - 4 burners • **DE** Gas-Kochplatte - 4 Kochstellen
• **FR** Rechaud gaz - 4 feux vifs • **ES** Sobres de cocción gas - 4 quemadores
cm. 60x 60x 28h



⚡ 18 kW 1.800,00
15.480 kcal/h 31 / 0,28

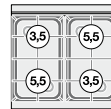

PCT-610G PIANO COTTURA A GAS, 6 FUOCHI
16211050 **EN** Gas heated boiling - 6 burners • **DE** Gas-Kochplatte - 6 Kochstellen
• **FR** Rechaud gaz - 6 feux vifs • **ES** Sobres de cocción gas - 6 quemadores
cm. 100x 60x 28h



⚡ 27 kW 2.897,00
23.220 kcal/h 63 / 0,46

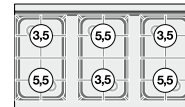

PCI1T-64G PIANO COTTURA A GAS, 1 FUOCO
16210451 **EN** Gas heated boiling - 1 burner • **DE** Gas-Kochplatte - 1 Kochstellen
• **FR** Rechaud gaz - 1 feux vifs • **ES** Sobres de cocción gas - 1 quemador
cm. 40x 60x 28h



⚡ 10 kW 1.108,00
8.600 kcal/h 23 / 0,19



PIANI COTTURA A GAS - TOP

MOD. _____
COD. _____

DESCRIZIONE/DESCRIPTION/BEZEICHNUNG/DESCRIPTION/DESCRIPCIÓN
DIMENSIONI/DIMENSIONS/ABMESSUNGEN/DIMENSIONS/DIMENSIONES

POTENZA/POWER/LEISTUNG/PUISSANCE/POTENCIA
VOLTAGGIO/VOLTAGE/SPANNUNG/VOLTAGE/VOLTAJE

⚡ kW kcal/h
⚡ kw V~ Hz

PREZZO/PRICE
PREIS/PRIX/PRECIO
KG / M³



PC2T-68G
16210851

PIANO COTTURA A GAS, 2 FUOCHI
EN Gas heated boiling - 2 burners • **DE** Gas-Kochplatte - 2 Kochstellen
• **FR** Rechaud gaz - 2 feux vifs • **ES** Sobres de cocción gas - 2 quemadores
cm. 80x 60x 28h



⚡ 17 kW
14.620 kcal/h

1.749,00
39 / 0,37

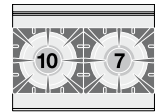

PC3T-612G
16211251

PIANO COTTURA A GAS, 3 FUOCHI
EN Gas heated boiling - 3 burners • **DE** Gas-Kochplatte - 3 Kochstellen
• **FR** Rechaud gaz - 3 feux vifs • **ES** Sobres de cocción gas - 3 quemadores
cm. 120x 60x 28h



⚡ 27 kW
23.220 kcal/h

2.559,00
54 / 0,55

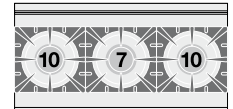

TP2T-64G
16290450

TUTTAPIASTRA A GAS PIASTRA CM 37X50
EN Solid top - Plate cm 37x50 • **DE** Kochplatte - Platte cm 37x50 • **FR**
Toute plaque - Plaque cm 37x50 • **ES** Placa de cocción - Placa cm 37x50
cm. 40x 60x 28h



⚡ 5,5 kW
4.730 kcal/h

1.898,00
54 / 0,19

TP4T-610G
16301050

TUTTA PIASTRA + 4 FUOCHI PIASTRA CM. 37X50
EN Solid top + 4 burners - Plate 37x50cm • **DE** Kochplatte + 4
Gaskochstellen - Platte 37x50 cm • **FR** Toute plaque + 4 brûleurs -
Plaque cm. 37x50 • **ES** Placa de cocción + 4 fuegos - Placa cm. 37x50
cm. 100x 60x 28h



⚡ 23,5 kW
20.210 kcal/h

4.053,00
103 / 0,46

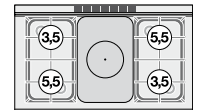

PLT-62
163010200

PIANO DI LAVORO
EN Worktop • **DE** Arbeitsplatte • **FR** Plan de travail • **ES** Sobre de
trabajo
cm. 20x 60x 28h

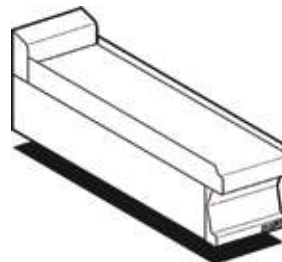

441,00
13 / 0,15

PLT-63
16010300

**PIANO DI LAVORO CON CASSETTO INOX CM.21X47X15H
INOX**
EN Worktop with inox drawer cm.21x47x15h inox • **DE** Arbeitsplatte
mit Schublade inox cm.21x47x15h inox • **FR** Plan de travail avec
 tiroir inox cm.21x47x15h inox • **ES** Sobre de trabajo con Cajón inox
cm.21x47x15h inox
cm. 30x 60x 28h



564,00
21 / 0,15

PIANI LAVORO - TOP

MOD. _____
COD. _____

DESCRIZIONE/DESCRIPTION/BEZEICHNUNG/DESCRIPTION/DESCRIPCIÓN
DIMENSIONI/DIMENSIONS/ABMESSUNGEN/DIMENSIONS/DIMENSIONES

POTENZA/POWER/LEISTUNG/PUISSANCE/POTENCIA
VOLTAGGIO/VOLTAGE/SPANNUNG/VOLTAGE/VOLTAJE

⚡ kW kcal/h
⚡ kw V~ Hz

PREZZO/PRICE
PREIS/PRIX/PRECIO
KG / M³



PLT-64
16010400

PIANO DI LAVORO CON CASSETTO INOX CM.31X47X15H INOX

EN Worktop with inox drawer cm.31x47x15h inox • **DE** Arbeitsplatte mit Schublade inox cm.31x47x15h inox • **FR** Plan de travail avec tiroir inox cm.31x47x15h inox • **ES** Sobre de trabajo con Cajón inox cm.31x47x15h inox
cm. 40x 60x 28h



594,00
22 / 0,19

PLT-66
16010600

PIANO DI LAVORO CON CASSETTO INOX CM.51X47X15H INOX

EN Worktop with inox drawer cm.51x47x15h inox • **DE** Arbeitsplatte mit Schublade inox cm.51x47x15h inox • **FR** Plan de travail avec tiroir inox cm.51x47x15h inox • **ES** Sobre de trabajo con Cajón inox cm.51x47x15h inox
cm. 60x 60x 28h



847,00
25 / 0,28

PLT-68
16010800

PIANO DI LAVORO CON CASSETTO INOX CM.71X47X15H INOX

EN Worktop with inox drawer cm.71x47x15h inox • **DE** Arbeitsplatte mit Schublade inox cm.71x47x15h inox • **FR** Plan de travail avec tiroir inox cm.71x47x15h inox • **ES** Sobre de trabajo con Cajón inox cm.71x47x15h inox
cm. 80x 60x 28h

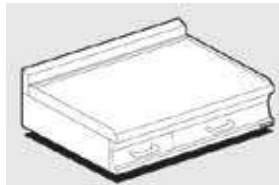

1.037,00
38 / 0,37

PLT-610
16011000

PIANO DI LAVORO CON 2 CASSETTI INOX, 1XCM.51X47X15H + 1XCM.31X47X15H

EN Worktop with 2 inox drawers, 1xcm.51x47x15h + 1xcm.31x47x15h • **DE** Arbeitsplatte mit 2 Schublade inox, 1xcm.51x47x15h + 1xcm.31x47x15h • **FR** Plan de travail avec 2 tiroirs inox, 1xcm.51x47x15h + 1xcm.31x47x15h • **ES** Sobre de trabajo con 2 Cajónes inox, 1xcm.51x47x15h + 1xcm.31x47x15h
cm. 100x 60x 28h

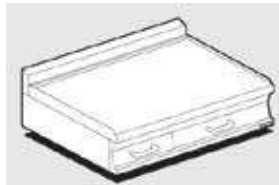

1.439,00
51 / 0,46

PLA-68
06010801

PIANO DI LAVORO AD ANGOLO SU MOBILE

EN Corner base with door • **DE** Eckschrank mit Tür • **FR** Placard d'angle avec porte • **ES** Base angular con puerta
cm.80÷80x 60x 90h



1.717,00
50 / 0,89

LAT-64
16020400

LAVELLO 1 VASCA RUBINETTO A LEVA - VASCA CM 29X35X14H

EN Sink unit - Lever type tap - Bowl cm 29x35x14h • **DE** Spülbecken - Einhebel-Mischbatterie Becken cm 29x35x14h • **FR** Bac-évier avec robinetterie - Bac cm 29x35x14h • **ES** Fregadero - Grifo a palanca - Pileta cm 29x35x14h
cm. 40x 60x 28h



967,00
20 / 0,19

LAT-68
16020800

LAVELLO 2 VASCHE CM 29X35X14H RUBINETTO A LEVA

EN Sink unit - Lever type tap - 2 Bowls cm 29x35x14h • **DE** Spülbecken - Einhebel-Mischbatterie 2 Becken cm 29x35x14h • **FR** Bac-évier avec robinetterie - 2 Bac cm 29x35x14h • **ES** Fregadero - Grifo a palanca - 2 Pileta cm 29x35x14h
cm. 80x 60x 28h



1.470,00
32 / 0,37

MOD. _____
COD. _____

DESCRIZIONE/DESCRIPTION/BEZEICHNUNG/DESCRIPTION/DESCRIPCIÓN
DIMENSIONI/DIMENSIONS/ABMESSUNGEN/DIMENSIONS/DIMENSIONES

POTENZA/POWER/LEISTUNG/PUISSANCE/POTENCIA
VOLTAGGIO/VOLTAGE/SPANNUNG/VOLTAGE/VOLTAJE

⚡ kW _____
kcal/h _____
⚡ kw _____
V~ _____
Hz _____

PREZZO/PRICE
PREIS/PRIX/PRECIO
KG / M³



LAT-610DX
16021000

**LAVELLO PREDISPOSTO - VASCA CM 29X35X14H DX
SGOCCIOLATOIO CM 60 SX - RUBINETTO A LEVA A NORME.**
EN Sink unit - R/h Bowl cm 29x35x14h - L/h Draining board cm 60
Suitable for dishwasher - Lever type tap. • **DE** Spülbecken - Becken
cm 29x35x14h rechts Abtropffläche cm 60 links - Vorbereitung für
Geschirrspülmaschine - Einhebel-Mischbatterie • **FR** Plan evier - Bac
à droite cm 29x35x14h Égouttoir à gauche cm 60 Prêdisposé pour
lave-vaisselle Robinetterie • **ES** Fregadero predispuesto - Pileta cm
29x35x14h derecho Escurridor 60 cm izq. - Grifo a palanca según
normativa
cm. 100x 60x 28h



1.331,00
36 / 0,46

LAT-610SX
16021001

**LAVELLO PREDISPOSTO - VASCA CM 29X35X14H SX
SGOCCIOLATOIO CM 60 DX - RUBINETTO A LEVA A NORME.**
EN Sink unit - L/h Bowl cm 29x35x14h - R/h Draining board cm 60
Suitable for dishwasher - Lever type tap. • **DE** Spülbecken - Becken
cm 29x35x14h links Abtropffläche cm 60 rechts - Vorbereitung für
Geschirrspülmaschine - Einhebel-Mischbatterie • **FR** Plan evier - Bac
à gauche cm 29x35x14h Égouttoir à droite cm 60 Prêdisposé pour
lave-vaisselle Robinetterie • **ES** Fregadero predispuesto - Pileta cm
29x35x14h izq. Escurridor 60 cm derecho - Grifo a palanca según
normativa
cm. 100x 60x 28h



1.331,00
36 / 0,46

LAA-68
06020801

LAVELLO AD ANGOLO SU MOBILE VASCA CM 50X40X20H
EN Corner base with sink and door Bowl cm 50x40x20h • **DE**
Eckschrank mit Spülbecken und mit Tür Becken cm 50x40x20h • **FR**
Placard d'angle avec porte et evier Cuve cm 50x40x20h • **ES** Con
fregadero y puerta cm. Cuba cm 50x40x20h
cm.80÷80x 60x 90h



1.984,00
50 / 0,89

MFM-68EM
06490812

**BASE CON FORNO ELETTRICO MULTIFUNZIONE CM.
46X37X35H, TEMP: 50÷250°C, CON 1 GRIGLIA CM.41X32,5
- PORTA VETRO (NON SOVRAPPORRE ELEMENTI AD
INDUZIONE)**
EN Stand with Multifunction electric oven cm. 46x37x35h, temp:
50÷250°C, with 1 grid cm.41x32,5 - Glass door (no induction top)
• **DE** unterbau mit Multifunktions-Elektroofen cm. 46x37x35h, temp:
50÷250°C, mit 1 Rost cm.41x32,5 - Glastür (nicht Induktions) • **FR**
placard avec Four électrique à fonctions multiples cm. 46x37x35h,
temp: 50÷250°C, avec 1 grille cm.41x32,5 - Porte vitrée (il faut pas
de induction) • **ES** mueble con Horno eléctrico multifuncional cm.
46x37x35h, temp: 50÷250°C, con 1 parilla cm.41x32,5 - Puerta vidrio
(no inducción)
cm. 80x 57,5x 57h



⚡ 3,05 kW _____ **2.733,00**
230V~ _____ 51 / 0,43
50/60 Hz

MFM-68EM
06490813

**BASE CON FORNO ELETTRICO MULTIFUNZIONE CM.
46X37X35H, TEMP: 50÷250°C, CON 1 GRIGLIA CM.41X32,5
- PORTA CIECA INOX (NON SOVRAPPORRE ELEMENTI AD
INDUZIONE)**
EN Stand with Multifunction electric oven cm. 46x37x35h, temp:
50÷250°C, with 1 grid cm.41x32,5 - Stainless steel door (no induction
top) • **DE** unterbau mit Multifunktions-Elektroofen cm. 46x37x35h, temp:
50÷250°C, mit 1 Rost cm.41x32,5 - Edelstahltür (nicht Induktions) • **FR**
placard avec Four électrique à fonctions multiples cm. 46x37x35h, temp:
50÷250°C, avec 1 grille cm.41x32,5 - Porte acier inoxydable (il faut
pas de induction) • **ES** mueble con Horno eléctrico multifuncional cm.
46x37x35h, temp: 50÷250°C, con 1 parilla cm.41x32,5 - Puerta ciega
inox (no inducción)
cm. 80x 57,5x 57h



⚡ 3,05 Kw _____ **2.733,00**
230V~ _____ 51 / 0,43
50/60 Hz

BASE CON FORNO ELETTRICO

MOD.
COD.

DESCRIZIONE/DESCRIPTION/BEZEICHNUNG/DESCRIPTION/DESCRIPCIÓN
DIMENSIONI/DIMENSIONS/ABMESSUNGEN/DIMENSIONS/DIMENSIONES

POTENZA/POWER/LEISTUNG/PUISSANCE/POTENCIA
VOLTAGGIO/VOLTAGE/SPANNUNG/VOLTAGE/VOLTAJE

⚡ kW kcal/h
230V~
50/60 Hz

PREZZO/PRICE
PREIS/PRIX/PRECIO
KG / M³



MFM-610EM BASE CON FORNO ELETTRICO MULTIFUNZIONE CM.
06491012 **64X37X35H, TEMP: 50÷250°C, CON 1 GRIGLIA CM.53X32,5 GN1/1 - PORTA VETRO (NON SOVRAPPORRE ELEMENTI AD INDUZIONE)**

EN Stand with Multifunction electric oven cm. 64x37x35h, temp: 50÷250°C, with 1 grid cm.53x32,5 GN1/1 - Glass door (no induction top) • **DE** unterbau mit Multifunktions-Elektroofen cm. 64x37x35h, temp: 50÷250°C, mit 1 Rost cm.53x32,5 GN1/1 - Glastür (nicht Induktions) • **FR** placard avec Four électrique à fonctions multiples cm. 64x37x35h, temp: 50÷250°C, avec 1 grille cm.53x32,5 GN1/1 - Porte vitrée (il faut pas de induction) • **ES** mueble con Horno eléctrico multifuncional cm. 64x37x35h, temp: 50÷250°C, con 1 parilla cm.53x32,5 GN1/1 - Puerta vidrio (no inducción)
cm. 100x 57,5x 57h



⚡ 3,05 kW **3.018,00**
230V~ 59 / 0,53
50/60 Hz

MFM-610EM BASE CON FORNO ELETTRICO MULTIFUNZIONE CM.
06491013 **64X37X35H, TEMP: 50÷250°C, CON 1 GRIGLIA CM.53X32,5 GN1/1 - PORTA CIECA INOX (NON SOVRAPPORRE ELEMENTI AD INDUZIONE)**

EN Stand with Multifunction electric oven cm. 64x37x35h, temp: 50÷250°C, with 1 grid cm.53x32,5 GN1/1 - Stainless steel door (no induction top) • **DE** unterbau mit Multifunktions-Elektroofen cm. 64x37x35h, temp: 50÷250°C, mit 1 Rost cm.53x32,5 GN1/1 - Edelstahltür (nicht Induktions) • **FR** placard avec Four électrique à fonctions multiples cm. 64x37x35h, temp: 50÷250°C, avec 1 grille cm.53x32,5 GN1/1 - Porte acier inoxydable (il faut pas de induction) • **ES** mueble con Horno eléctrico multifuncional cm. 64x37x35h, temp: 50÷250°C, con 1 parilla cm.53x32,5 GN1/1 - Puerta ciega inox (no inducción)
cm. 100x 57,5x 57h



⚡ 3,05 kW **3.018,00**
230V~ 59 / 0,53
50/60 Hz

CMF-68 COPERCHIO PER MFM-68E
06490800 **EN** Lid for MFM-68E • **DE** Berichterstattung für MFM-68E • **FR** Couvercle pour MFM-68E • **ES** cubertura para MFM-68E
cm. 80x 54x 2,8h



207,00
4 / 0,02

CMF-610 COPERCHIO PER MFM-610E
06491000 **EN** Lid for MFM-610E • **DE** Berichterstattung für MFM-610E • **FR** Couvercle pour MFM-610E • **ES** cubertura para MFM-610E
cm. 100x 54x 2,8h

266,00
5 / 0,03

MPI-64 BASE CON PORTA PER INDUZIONE
06410403 **EN** Stand with door for induction top • **DE** Unterbau für Induktions mit Tür • **FR** Placard pour induction avec porte • **ES** Mueble base para inducción con puerta
cm. 40x 51x 57h



628,00
18,5 / 0,19

M-62 BASE NEUTRA
06410200 **EN** Stand • **DE** Unterbau • **FR** Placard • **ES** Mueble base
cm. 20x 48,5x 57h



360,00
11 / 0,15

MOBILI BASE

MOD. _____
COD. _____

DESCRIZIONE/DESCRIPTION/BEZEICHNUNG/DESCRIPTION/DESCRIPCIÓN
DIMENSIONI/DIMENSIONS/ABMESSUNGEN/DIMENSIONS/DIMENSIONES

POTENZA/POWER/LEISTUNG/PUISSANCE/POTENCIA
VOLTAGGIO/VOLTAGE/SPANNUNG/VOLTAGE/VOLTAJE

↓ kW kcal/h
↗ kW V~ Hz

PREZZO/PRICE
PREIS/PRIX/PRECIO
KG / M³



M-63 06410300	BASE NEUTRA A GIORNO EN Open Stand • DE Offener Unterbau • FR Placard ouvert • ES Mueble base abierto cm. 30x 48,5x 57h		350,00 13 / 0,15
M-64 06410400	cm. 40x 48,5x 57h		392,00 15 / 0,19
M-66 06410600	cm. 60x 48,5x 57h		434,00 19 / 0,28
M-67 06410700	cm. 70x 48,5x 57h		476,00 20 / 0,37
M-68 06410800	cm. 80x 48,5x 57h		508,00 22 / 0,37
M-69 06410900	cm. 90x 48,5x 57h		634,00 25 / 0,53
M-610 06411000	cm. 100x 48,5x 57h		663,00 27 / 0,53
M-612 06411200	cm. 120x 48,5x 57h		708,00 32 / 0,55
S-63 06400300	CAVALLETTO BASE EN Stand • DE Untergestell • FR Piedement simple • ES Soporte base cm. 30x 48,5x 57h		407,00 18 / 0,15
S-64 06400400	cm. 40x 48,5x 57h		427,00 19 / 0,19
S-66 06400600	cm. 60x 48,5x 57h		441,00 23 / 0,28
S-68 06400800	cm. 80x 48,5x 57h		545,00 26 / 0,37
S-610 06401000	cm. 100x 48,5x 57h		594,00 29 / 0,46
PM-63/73/93-DX 08430302	PORTA 300 DESTRA EN Right door 300 • DE Rechte tür 300 • FR Porte droite 300 • ES Puerta derecha 300 cm. 29,5x 2,5x 47,5h		197,00 3 / 0,01

MOD.
COD.

DESCRIZIONE/DESCRIPTION/BEZEICHNUNG/DESCRIPTION/DESCRIPCIÓN
DIMENSIONI/DIMENSIONS/ABMESSUNGEN/DIMENSIONS/DIMENSIONES

POTENZA/POWER/LEISTUNG/PUISSANCE/POTENCIA
VOLTAGGIO/VOLTAGE/SPANNUNG/VOLTAGE/VOLTAJE

⚡ kW
kcal/h

⚡ kw
V~
Hz

PREZZO/PRICE
PREIS/PRIX/PRECIO
KG / M³



PM-64/74/94-DX PORTA 400 DESTRA
08430402 **EN** Right door 400 • **DE** Rechte tür 400 • **FR** Porte droite 400 • **ES**
Puerta derecha 400
cm. 39,5x 2,5x 47,5h



204,00
3.5 / 0,02

PM-63/73/93-SX PORTA 300 SINISTRA
08430303 **EN** Left door 300 • **DE** Linke tür 300 • **FR** Porte gauche 300 • **ES**
Puerta izquierda 300
cm. 29,5x 2,5x 47,5h



197,00
3 / 0,01

PM-64/74/94-SX PORTA 400 SINISTRA
08430403 **EN** Left door 400 • **DE** Linke tür 400 • **FR** Porte gauche 400 • **ES**
Puerta izquierda 400
cm. 39,5x 2,5x 47,5h

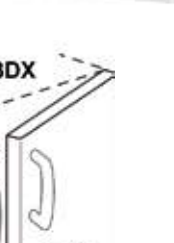

204,00
3.5 / 0,02

M-610 =PM-64SX+PM-63SX+PM-63DX

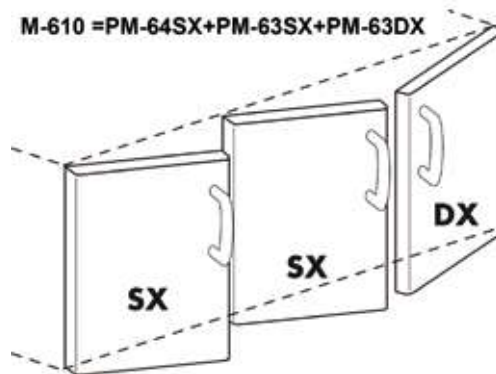

C-63 CASSETTIERA 300/400/600 - N. 2 CASSETTI CON VASCA
06440320 **INOX GUIDE TELESCOPICHE**
EN Drawer set 300/400/600 - N. 2 drawers with inox pans, telescopic guides • **DE** Schubladen 300/400/600 - N. 2 Schubladen mit chromnickelstahl Telescopeinführungen • **FR** Tiroirs pour meuble de 300/400/600 - N. 2 tiroirs avec cuve inox, Guides télescopiques • **ES** Cajonera 300/400/600 - N. 2 cajones con cuba de acero inox, Guías telescópicas
cm. 29,5x 51x 47,5h



687,00
8 / 0,15

C-64 **cm. 39,5x 51x 47,5h**
06440420

709,00
9 / 0,19

C-66 **cm. 59,5x 51x 47,5h**
06440620



829,00
14 / 0,28

ACCESSORI

MOD.
COD.

DESCRIZIONE/DESCRIPTION/BEZEICHNUNG/DESCRIPTION/DESCRIPCIÓN
DIMENSIONI/DIMENSIONS/ABMESSUNGEN/DIMENSIONS/DIMENSIONES

POTENZA/POWER/LEISTUNG/PUISSANCE/POTENCIA
VOLTAGGIO/VOLTAGE/SPANNUNG/VOLTAGE/VOLTAJE

⚡ kW
kcal/h

⚡ kw
V~
Hz

PREZZO/PRICE
PREIS/PRIX/PRECIO
KG / M³



R-63
06450300

RIPIANO 300
EN Shelf 300 • **DE** Zwischenboden 300 • **FR** Etagère 300 • **ES**
Estante 300
cm. 25x 48x 2h

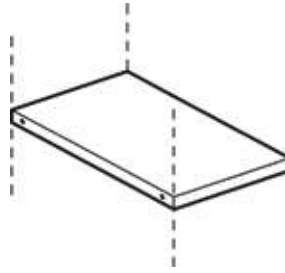

83,00
1,5 / 0,01

R-64
06450400

RIPIANO 400
EN Shelf 400 • **DE** Abstellbrett 400 • **FR** Etagère 400 • **ES** Estante
400
cm. 35x 48x 2h

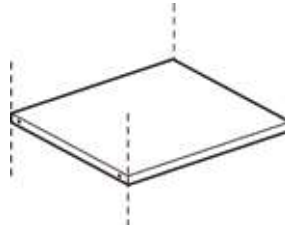

93,00
2,5 / 0,01

R-66
06450600

RIPIANO 600
EN Shelf 600 • **DE** Abstellbrett 600 • **FR** Etagère 600 • **ES** Estante
600
cm. 55x 48x 2h



105,00
3 / 0,01

544023800 RASCHIETTO PER PIASTRA RIGATA

EN Scraper for gooved plate • **DE** Schaber für gerillte Kochplatte • **FR**
Racloir pour plaque nervurée • **ES** Rasqueta para placa ranurada



64,00
/ 1,00

531040800 RASCHIETTO PER PIASTRA LISCIA AL CROMO LUCIDO

EN Scraper for smooth POLISHED CHROME plate • **DE** Schaber für
platte POLIERTEM CHROM Platte • **FR** Racloir pour plaque lisse au
CHROME POLI • **ES** Rasqueta para placa lisa de CROMO PULIDO



58,00
/ 1,00

531040900 KIT 10 LAME PER RASCHIETTO COD.531040800

EN 10 blades kit for scraper cod.531040800 • **DE** Kit 10 klingen
für Schaber cod.531040800 • **FR** Kit de 10 lames pour racloir
cod.531040800 • **ES** Kit de 10 cuchillas para rasqueta cod.531040800

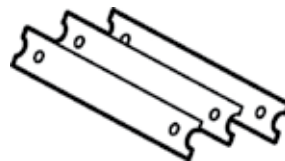

42,00
/ 0,00

T-FT
09580060

TAPPO PER FRY-TOP
EN stopper for Fry-top • **DE** Stopfen griddleplatte • **FR** bouchon pour
Plaque • **ES** tapón Fry-top
cm. 10x 2x 5h



248,00
/ 0,00

ACCESSORI FRY-TOP

MOD. _____
COD. _____





DESCRIZIONE/DESCRIPTION/BEZEICHNUNG/DESCRIPTION/DESCRIPCIÓN
DIMENSIONI/DIMENSIONS/ABMESSUNGEN/DIMENSIONS/DIMENSIONES

POTENZA/POWER/LEISTUNG/PUISSANCE/POTENCIA
VOLTAGGIO/VOLTAGE/SPANNUNG/VOLTAGE/VOLTAJE

⚡ kW kcal/h
⚡ kW V~ Hz

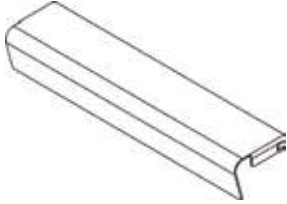
PREZZO/PRICE
PREIS/PRIX/PRECIO
KG / M³

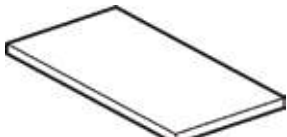

PFT-64 06620400	KIT PROTEZIONE FRONTALE PIANO FRY-TOP EN KIT front protection plan fry-top • DE Schutz-kit vorne Plan griddleplatte • FR KIT protection avant plan plaque • ES KIT de protección frontal plan de fry-top cm. 38x 8x 6h		127,00 / 0,00
PFT-66 06620600	cm. 58x 8x 6h		172,00 / 0,01
PFT-68 06620800	cm. 78x 8x 6h		216,00 / 0,01
PFT-610 06621000	cm. 98x 8x 6h		245,00 / 0,01
CG-60 06560000	COPRIGIUNTO EN Joint cover • DE Klemmsteg • FR Couvre-joint • ES Cubre junta cm. 0,7x 52x 1,2h		35,00 0.12 / 1,00
06550400	COPERCHIO BRF-64 EN Lid BRF-64 • DE Deckel BRF-64 • FR Couvercle BRF-64 • ES Tapa BRF-64 cm. 33x 45x 5h		139,00 / 0,02
06550600	COPERCHIO BRT-66 EN Lid BRF-66 • DE Deckel BRF-66 • FR Couvercle BRF-66 • ES Tapa BRF-66 cm. 51x 42x 3h		140,00 / 0,02
TG-63 06580300	TAGLIERE PLASTICA EN Plastic chopping-board • DE Schneidebrett • FR Plan de decoupe • ES Picador de plástico cm. 29x 52,5x 2,5h		128,00 4 / 0,01
TG-64 06580400	cm. 39x 52,5x 2,5h		140,00 6 / 0,01
TG-66 06580600	cm. 59x 52,5x 2,5h		234,00 9 / 0,01
TG-68 06580800	cm. 79x 52,5x 2,5h		275,00 11 / 0,02
PLF/62 06590421	PIASTRA LISCIA 2 FUOCHI EN Smooth griddle plate 2 burners • DE Fortkochplatte glatt 2 Kochstellen • FR Plaque lisse 2 feux • ES Plancha lisa 2 quemadores cm. 29x 50		228,00 15 / 0,01
PRF/62 06590423	PIASTRA RIGATA 2 FUOCHI EN Grooved griddle plate 2 burners • DE Fortkochplatte gerillt 2 Kochstellen • FR Plaque nervurée 2 feux • ES Plancha estriada 2 quemadores cm. 29x 50		334,00 15 / 0,01

ACCESSORI

MOD. _____
COD. _____

DESCRIZIONE/DESCRIPTION/BEZEICHNUNG/DESCRIPTION/DESCRIPCIÓN
DIMENSIONI/DIMENSIONS/ABMESSUNGEN/DIMENSIONS/DIMENSIONES

POTENZA/POWER/LEISTUNG/PUISSANCE/POTENCIA
VOLTAGGIO/VOLTAGE/SPANNUNG/VOLTAGE/VOLTAJE

⚡ kW kcal/h
⚡ kw V~ Hz

PREZZO/PRICE
PREIS/PRIX/PRECIO
KG / M³



533009100 GRIGLIA DI RIDUZIONE

EN Reduction • DE Reduzierstern • FR Grille de réduction • ES Rejilla de reducción
cm. 15x 15



22,00
0,2 / 0,00

533009200 GRIGLIA DI RIDUZIONE PER PC1/2/3T E CF2/3

EN Reduction PC1/2/3T & CF2/3 • DE Reduzierstern PC1/2/3T & CF2/3 • FR Grille de réduction PC1/2/3T & CF2/3 • ES Rejilla de reducción PC1/2/3T & CF2/3
cm. 25x 25

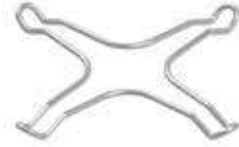

40,00
0.2 / 0,00

RV
08660410

RISCALDANTE VANO

EN Heater for cabinet • DE Heizer für Schrankelement • FR Réchauffeur pour armoire • ES elemento de calefacción para armario neutro
cm. 32x 48,5x 8h

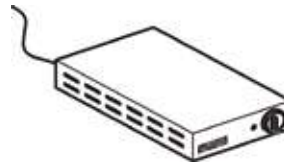

⚡ 0,75 kW
230V~
50/60 Hz

903,00
8 / 0,08

RRV-64
06450410

RIPIANO FORATO IN APPOGGIO PER RISCALDANTE (NO CF)

EN Perforated shelf for heater element mod.RV (NO CF) • DE regale Gelocht für Heizer mod.RV (NO CF) • FR Étagère perforées pour réchauffeur mod.RV (NO CF) • ES estante perforado para elemento de calefacción mod.RV (NO CF)
cm. 34x 46x 10h



312,00
4 / 0,02

RRV-66
06450601

cm. 54x 46x 10h

469,00
5 / 0,04

RRV-67
06450701

cm. 64x 46x 10h

590,00
6 / 0,04

RRV-68
06450801

cm. 74x 46x 10h

601,00
7 / 0,05

RRV-69
06450901

cm. 84x 46x 10h

756,00
8 / 0,06

RRV-610
06451001

cm. 94x 46x 10h

850,00
10 / 0,06

RRV-612
06451201

cm. 114x 46x 10h

1.012,00
12 / 0,08

KIT-WOK
09580040

KIT WOK - FIAMMA VERTICALE - SOLO SU BRUCIATORE DA 10 KW E GRIGLIE IN GHISA

EN KIT WOK - vertical flame - only for 10 kW burner and cast iron grills
• DE KIT WOK - vertikaler Flamme - nur 10 kW-Brenner und Roste aus Gusseisen • FR KIT WOK - verticale de la flamme - seulement 10 kW brûleur et grilles en fonte • ES KIT WOK - llama vertical - sólo 10 kW quemador y parrilas de hierro colado
cm. Ø 26x 16h



422,00
5 / 0,02

544439900 ANELLO PER WOK - SOLO PER GRIGLIE IN GHISA

EN Wok ring - only for cast iron grills • DE Wok Aufsatzring - nur für Roste aus Gusseisen • FR Anneau Wok - seulement pour grilles en fonte • ES Anillo Wok - solo para parrilas de hierro colado
cm. Ø22,5x 3,5h



157,00
2 / 0,00

ACCESSORI

MOD.
COD.

DESCRIZIONE/DESCRIPTION/BEZEICHNUNG/DESCRIPTION/DESCRIPCIÓN
DIMENSIONI/DIMENSIONS/ABMESSUNGEN/DIMENSIONS/DIMENSIONES

POTENZA/POWER/LEISTUNG/PUISSANCE/POTENCIA
VOLTAGGIO/VOLTAGE/SPANNUNG/VOLTAGE/VOLTAJE

⚡ kcal/h
⚡ kw
V~
Hz

PREZZO/PRICE
PREIS/PRIX/PRECIO
KG / M³



SIA-7/9
08480000

STAFFA INFERIORE UNIONE APPARECCHI
EN Lower bracket to join two items

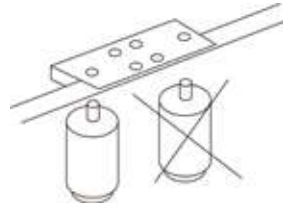

59,00
2 / 0,00

SR-100
50900001

SET 4 RUOTE Ø 100X30, 2 CON FRENO
EN Set of 4 wheels Ø 100x30, 2 with brake • **DE** 4 Rollen Satz Ø 100x30, 2 davon mit Feststellbremse • **FR** Kit 4 roues Ø 100x30, 2 avec frein • **ES** Equipo 4 ruedas Ø 100x30, 2 con frenos
cm. 12,7h

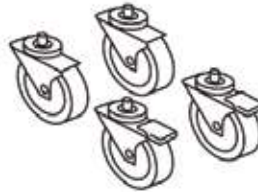

355,00
1 / 0,01

ZB
01410000

ZOCCOLATURA BASE
EN FRONT PLINTH • **DE** GRUNDSOCKEL • **FR** PLINTHE FRONTAL
• **ES** ZOCCOLOS BASE
€/m x cm. 15h



143,00
/

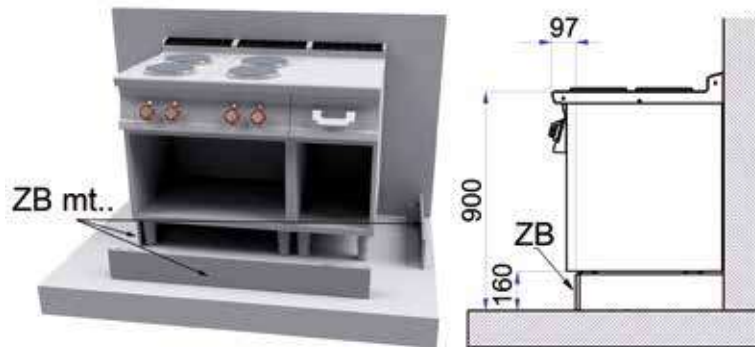

ZA
01410002

ZOCCOLATURA ANGOLO
EN CORNER PLINTH • **DE** EKE-SOCKEL • **FR** PLINTHE ANGLE • **ES** ZOCCOLOS ANGULAR
cm. 15h

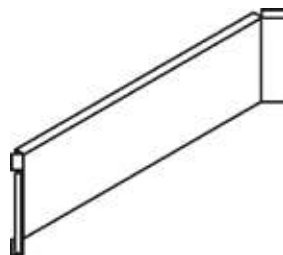

86,00
0.3 / 0,01

D-60
06470000

DIVISORIO - NECESSARIO PER APPLICARE CASSETTIERA C-64 SU MOBILE 70/80
EN Spacer - For installation of a C-64 on a stand 70/80 • **DE** Trennwand - Um ein C-64 an einem Unterschrank 70/80 einzubauen
• **FR** Separation - Pour l'installation de C-64 sur placard 70/80 • **ES** Divisorio - Necesario para aplicar cajoneras C-64 en Mueble 70/80
cm. 5x 48x 38h



152,00
2 / 0,02

ACCESSORI

MOD. _____
COD. _____

DESCRIZIONE/DESCRIPTION/BEZEICHNUNG/DESCRIPTION/DESCRIPCIÓN
DIMENSIONI/DIMENSIONS/ABMESSUNGEN/DIMENSIONS/DIMENSIONES

POTENZA/POWER/LEISTUNG/PUISSANCE/POTENCIA
VOLTAGGIO/VOLTAGE/SPANNUNG/VOLTAGE/VOLTAJE

⚡ kW kcal/h
⚡ kw V~ Hz

PREZZO/PRICE
PREIS/PRIX/PRECIO
KG / M³



PT-64
06460002

PORTATEGLIE VANO - 400 (GN2/3) - VANO 600 (GN1/1)
EN Frame for oven plates. 400 GN 2/3 - 600 GN 1/1 • **DE**
Auflangeschienen für Backbleche. 400 GN 2/3 - 600 GN 1/1 • **FR** Kit
porte-plaques. 400 GN 2/3 - 600 GN 1/1 • **ES** Portacazuelas. 400
GN 2/3 - 600 GN 1/1
cm. 2x 47x 30h

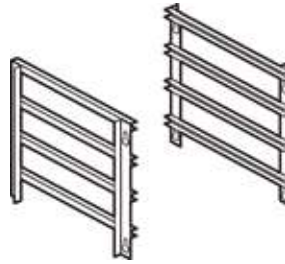

321,00
2,5 / 0,01

06570401

GRIGLIA TONDINO PER CW64 (SERIE 60)
EN Grid for CW-64 (60 line) • **DE** Gitter für CW-64 (60. Serie) • **FR**
Grille ronde pour CW-64 (serie 60) • **ES** Rejilla para CW-64 (serie 60)
cm. 38x 42



380,00
9 / 0,02

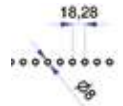

06570601

GRIGLIA TONDINO PER CW66 (SERIE 60)
EN Grid for CW-66 (60 line) • **DE** Gitter für CW-66 (60. Serie) • **FR**
Grille ronde pour CW-66 (serie 60) • **ES** Rejilla para CW-66 (serie 60)
cm. 58x 42



541,00
9 / 0,03

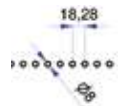

06570402

GRIGLIA TEGOLO V PER CW-64 (SERIE 60)
EN V TRAY for CW-64 (60 LINE) • **DE** V ROSTE FÜR CW-64 (60
LINIE) • **FR** V GRILLE POUR CW-64 (LIGNE 60) • **ES** V rejilla para
CW-64 (serie 60)
cm. 36x 43



259,00
9 / 0,02

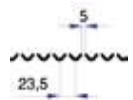

06570602

GRIGLIA TEGOLO V PER CW-66 (SERIE 60)
EN V TRAY for CW-66 (60 LINE) • **DE** V ROSTE FÜR CW-66 (60
LINIE) • **FR** V GRILLE POUR CW-66 (LIGNE 60) • **ES** V rejilla para
CW-66 (serie 60)
cm. 56x 43



374,00
9 / 0,03

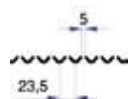

531017900

CESTO 1/3 PER CP-66
EN Basket 1/3 for CP-66 • **DE** Korb 1/3 für CP-66 • **FR** Panier 1/3
pour CP-66 • **ES** Cesta 1/3 para CP-66
cm. 16x 29x 20h

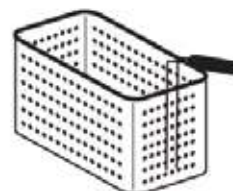

..179..

134,00
1,5 / 0,05

531064300

CESTO 1/4 PER CP-66
EN Basket 1/4 for CP-66 • **DE** Korb 1/4 für CP-66 • **FR** Panier 1/4
pour CP-66 • **ES** Cesta 1/4 para CP-66
cm. 11,5x 29x 20h

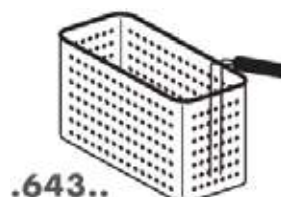

.643..

120,00
1,2 / 0,04

ACCESSORI CUOCIPASTA

MOD.
COD.

DESCRIZIONE/DESCRIPTION/BEZEICHNUNG/DESCRIPTION/DESCRIPCIÓN
DIMENSIONI/DIMENSIONS/ABMESSUNGEN/DIMENSIONS/DIMENSIONES

POTENZA/POWER/LEISTUNG/PUISSANCE/POTENCIA
VOLTAGGIO/VOLTAGE/SPANNUNG/VOLTAGE/VOLTAJE

⚡ kW kcal/h
⚡ kw V~ Hz

PREZZO/PRICE
PREIS/PRIX/PRECIO
KG / M³



531053900 CESTO 1/1 PER CP-66

EN Basket 1/1 for CP-66 • **DE** Korb 1/1 für CP-66 • **FR** Panier 1/1 pour CP-66 • **ES** Cesta 1/1 para CP-66
cm. 49x 29x 20h

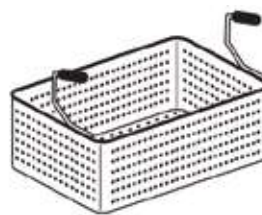

..539..

183,00
3,5 / 0,08

531018800 CESTO 1/2 PER CPT-64 - 1/3 PER CPT-66

EN Basket 1/2 for CPT-64 - 1/3 for CPT-66 • **DE** Korb 1/2 für CPT-64 - 1/3 für CPT-66 • **FR** Panier 1/2 pour CPT-64 - 1/3 pour CPT-66 • **ES** Cesta 1/2 para CPT-64 - 1/3 para CPT-66
cm. 14,5x 29x 15h

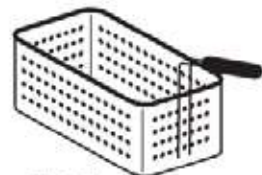

..188..

128,00
1,3 / 0,04

531053800 CESTO 1/4 PER CPT-66

EN Basket 1/4 for CPT-66 • **DE** Korb 1/4 für CPT-66 • **FR** Panier 1/4 pour CPT-66 • **ES** Cesta 1/4 para CPT-66
cm. 11,5x 29x 15h

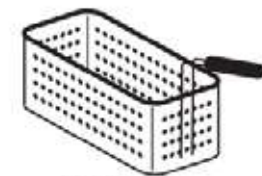

..538..

122,00
1,2 / 0,04

531040000 CESTO 1/1 PER CPT-66

EN Basket 1/1 for CPT-66 • **DE** Korb 1/1 für CPT-66 • **FR** Panier 1/1 pour CPT-66 • **ES** Cesta 1/1 para CPT-66
cm. 49x 29x 15h

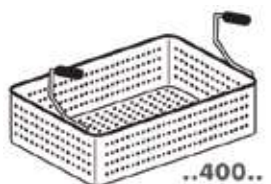

..400..

220,00
3,5 / 0,07

531048900 CESTO 1/6 PER CPT-64

EN Basket 1/6 for CPT-64 • **DE** Korb 1/6 für CPT-64 • **FR** Panier 1/6 pour CPT-64 • **ES** Cesta 1/6 para CPT-64
cm. 14x 10x 15h



80,00
1 / 0,01

531053700 CESTO 1/4 PER CPT-64

EN Basket 1/4 for CPT-64 • **DE** Korb 1/4 für CPT-64 • **FR** Panier 1/4 pour CPT-64 • **ES** Cesta 1/4 para CPT-64
cm. 14x 16x 15h

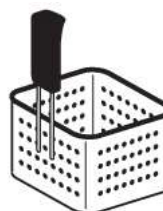

..537..

86,00
1 / 0,02

ACCESSORI CUOCIPASTA

MOD. _____
COD. _____

DESCRIZIONE/DESCRIPTION/BEZEICHNUNG/DESCRIPTION/DESCRIPCIÓN
DIMENSIONI/DIMENSIONS/ABMESSUNGEN/DIMENSIONS/DIMENSIONES

POTENZA/POWER/LEISTUNG/PUISSANCE/POTENCIA
VOLTAGGIO/VOLTAGE/SPANNUNG/VOLTAGE/VOLTAJE

⚡ kW kcal/h
⚡ kw V~ Hz

PREZZO/PRICE
PREIS/PRIX/PRECIO
KG / M³



531053500 CESTO 1/1 PER CPT-64

EN Basket 1/1 for CPT-64 • **DE** Korb 1/1 für CPT-64 • **FR** Panier 1/1 pour CPT-64 • **ES** Cesta 1/1 para CPT-64
cm. 29x 29x 15h

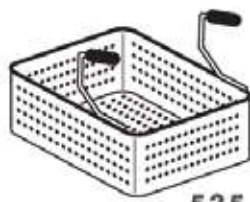

..535..

158,00
1,5 / 0,05

531071300 CESTO CON GANCIO 1/2 PER CPT-64 - 1/3 PER CPT-66

EN Basket with hook 1/2 for CPT-64 - 1/3 for CPT-66 • **DE** Korb mit Haken 1/2 für CPT-64 - 1/3 für CPT-66 • **FR** Panier avec crochet 1/2 pour CPT-64 - 1/3 pour CPT-66 • **ES** Cesta con gancho 1/2 para CPT-64 - 1/3 para CPT-66
cm. 13,5x 25,5x 15h

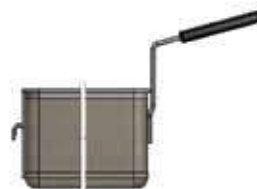

127,00
1,3 / 0,04

531071400 CESTO CON GANCIO 1/4 PER CPT-66

EN Basket with hook 1/4 for CPT-66 • **DE** Korb mit Haken 1/4 für CPT-66 • **FR** Panier avec crochet 1/4 pour CPT-66 • **ES** Cesta con gancho 1/4 para CPT-66
cm. 11x 25,5x 15h

120,00
1,2 / 0,03

531071200 CESTO CON GANCIO 1/3 PER CP-66

EN Basket with hook 1/3 for CP-66 • **DE** Korb mit Haken 1/3 für CP-66 • **FR** Panier avec crochet 1/3 pour CP-66 • **ES** Cesta con gancho 1/3 para CP-66
cm. 15x 26x 20h

146,00
1,5 / 0,05

531018700 CESTO CON GANCIO 1/4 PER CP-66

EN Basket with hook 1/4 for CP-66 • **DE** Korb mit Haken 1/4 für CP-66 • **FR** Panier avec crochet 1/4 pour CP-66 • **ES** Cesta con gancho 1/4 para CP-66
cm. 11x 26x 20h

121,00
1,2 / 0,04

531069400 GRIGLIA SUPPORTO CESTI CON GANCIO PER CP-66

EN support for baskets with hook for CP-66 • **DE** Unterstützung für Körbe mit Haken für CP-66 • **FR** soutien pour les paniers avec crochet pour CP-66 • **ES** soporte para cestas con gancho para CP-66
cm. 50x 29x 41h



181,00
4 / 0,09

531071800 GRIGLIA SUPPORTO CESTI CON GANCIO PER CPT-64

EN support for baskets with hook for CPT-64 • **DE** Unterstützung für Körbe mit Haken für CPT-64 • **FR** soutien pour les paniers avec crochet pour CPT-64 • **ES** soporte para cestas con gancho para CPT-64
cm. 30x 33x 25h



128,00
3 / 0,04

531071900 GRIGLIA SUPPORTO CESTI CON GANCIO PER CPT-66

EN support for baskets with hook for CPT-66 • **DE** Unterstützung für Körbe mit Haken für CPT-66 • **FR** soutien pour les paniers avec crochet pour CPT-66 • **ES** soporte para cestas con gancho para CPT-66
cm. 50x 30x 25h



166,00
3,5 / 0,06

ACCESSORI CUOCIPASTA

MOD.
COD.

DESCRIZIONE/DESCRIPTION/BEZEICHNUNG/DESCRIPTION/DESCRIPCIÓN
DIMENSIONI/DIMENSIONS/ABMESSUNGEN/DIMENSIONS/DIMENSIONES

POTENZA/POWER/LEISTUNG/PUISSANCE/POTENCIA
VOLTAGGIO/VOLTAGE/SPANNUNG/VOLTAGE/VOLTAJE

⚡ kW
kcal/h

⚡ kw
V~
Hz

PREZZO/PRICE
PREIS/PRIX/PRECIO
KG / M³



531013200 CESTO 1/2 PER F13-64E / F10T-63E

EN Basket 1/2 for F13-64E / F10T-63E • DE Korb 1/2 für F13-64E / F10T-63E • FR Panier 1/2 pour F13-64E / F10T-63E • ES Cesta 1/2 para F13-64E / F10T-63E
cm. 10x 30x 12h



58,00
0.7 / 0,03

531053300 CESTO 1/2 PER F13-64G

EN Basket 1/2 for F13-64G • DE Korb 1/2 für F13-64G • FR Panier 1/2 pour F13-64G • ES Cesta 1/2 para F13-64G
cm. 15x 27x 12h

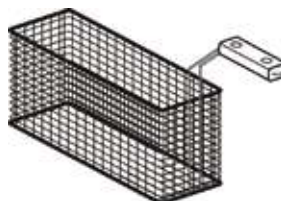

79,00
0.7 / 0,04

SA-62 SCHIENA POSTERIORE A VISTA PER APPARECCHI

06600200

EN Back cover • DE Rückenwand • FR Dos de finition • ES panel posterior
cm. 20x 1,5x 81h



104,00
2 / 0,01

SA-63

06600300

cm. 30x 1,5x 81h

118,00
3 / 0,01

SA-64

06600400

cm. 40x 1,5x 81h

135,00
3 / 0,01

SA-66

06600600

cm. 60x 1,5x 81h

196,00
4 / 0,02

SA-68

06600800

cm. 80x 1,5x 81h

229,00
5 / 0,02

SA-610

06601000

cm. 100x 1,5x 81h

285,00
6 / 0,03

SA-612

06601200

cm. 120x 1,5x 81h

344,00
7 / 0,03

SA-63FG SCHIENA POSTERIORE A VISTA PER FRIGGITRICI GAS

06600301

EN Back cover for Gas Fryer • DE Rückenwand für Gas-Friteuse • FR Dos de finition pour Friteuse a gaz • ES panel posterior para Freidoras a gas
cm. 30x 1,5x 90h

125,00
3 / 0,01

SA-66FG

06600601

cm. 60x 1,5x 90h

209,00
4 / 0,02

KIT-TOPM-SA KIT TAMPONAMENTI LATERALI PER SCHIENA POSTERIORE

08600001

EN Side KIT for back cover mounted on the TOP machine and Stand "M-.." • DE Seitliches KIT für Rückenwand montiert auf der TOP-Maschine und Unterbau "M-.." • FR KIT latéral pour Dos de finition monté sur la machine TOP et Placard "M-.." • ES KIT lateral para panel posteriore montado en la máquina TOP y Mueble base "M-.."

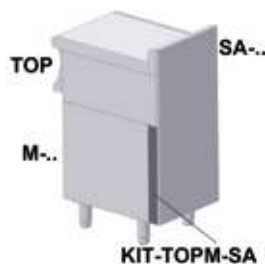

92,00
1 / 0,01

60

ACCESSORI

MOD.
COD.

DESCRIZIONE/DESCRIPTION/BEZEICHNUNG/DESCRIPTION/DESCRIPCIÓN
DIMENSIONI/DIMENSIONS/ABMESSUNGEN/DIMENSIONS/DIMENSIONES

POTENZA/POWER/LEISTUNG/PUISSANCE/POTENCIA
VOLTAGGIO/VOLTAGE/SPANNUNG/VOLTAGE/VOLTAJE

⚡ kW
kcal/h
⚡ kw
V~
Hz

PREZZO/PRICE
PREIS/PRIX/PRECIO
KG / M³



TMA-6SX
06540601

TESTATA 1 LATO SERIE 60 SINISTRA
EN Head 1 side S60 left • **DE** Abschluss element 1 seite S60 links • **FR** Element de jonction 1 coté S60 gauche • **ES** Embellecedor 1 lado S60 izquierda
cm. 0,2x 60



247,00
7 / 0,02

TMA-6DX
06540600

TESTATA 1 LATO SERIE 60 DESTRA
EN Head 1 side S60 right • **DE** Abschluss element 1 seite S60 recht • **FR** Element de jonction 1 coté S60 droit • **ES** Embellecedor 1 lado S60 derecha
cm. 0,2x 60



247,00
7 / 0,02

TMA-66
06546600

TESTATA 2 LATI SERIE 60
EN Head 2 sides S60 • **DE** Abschluss element seiten S60 • **FR** Element de jonction 2 cotés S60 • **ES** Embellecedor 2 lados S60
cm. 0,2x 120



494,00
14 / 0,04

TMA-67SX
06546701

TESTATA 2 LATI SERIE 60/70 SINISTRA
EN Head 2 sides S60/70 left • **DE** Abschluss element seiten S60/70 links • **FR** Element de jonction 2 cotés S60/70 gauche • **ES** Embellecedor 2 lados S60/70 izquierda
cm. 0,2x 130,5



505,00
15 / 0,04

TMA-67DX
06546700

TESTATA 2 LATI SERIE 60/70 DESTRA
EN Head 2 sides S60/70 right • **DE** Abschluss element seiten S60/70 recht • **FR** Element de jonction 2 cotés S60/70 droit • **ES** Embellecedor 2 lados S60/70 derecha
cm. 0,2x 130,5



505,00
15 / 0,04

TMA-69SX
06546901

TESTATA 2 LATI SERIE 60/90 SINISTRA
EN Head 2 sides S60/90 left • **DE** Abschluss element seiten S60/90 links • **FR** Element de jonction 2 cotés S60/90 gauche • **ES** Embellecedor 2 lados S60/90 izquierda
cm. 0,2x 150



532,00
16 / 0,04

ACCESSORI

MOD. _____
COD. _____

DESCRIZIONE/DESCRIPTION/BEZEICHNUNG/DESCRIPTION/DESCRIPCIÓN
DIMENSIONI/DIMENSIONS/ABMESSUNGEN/DIMENSIONS/DIMENSIONES

POTENZA/POWER/LEISTUNG/PUISSANCE/POTENCIA
VOLTAGGIO/VOLTAGE/SPANNUNG/VOLTAGE/VOLTAJE

⚡ kW kcal/h ⚡ kW V~ Hz

PREZZO/PRICE PREIS/PRIX/PRECIO
KG / M³



TMA-69DX
06546900

TESTATA 2 LATI SERIE 60/90 DESTRA

EN Head 2 sides S60/90 right • **DE** Abschluss element seiten S60/90 recht • **FR** Element de jonction 2 cotés S60/90 droit • **ES** Embellecedor 2 lados S60/90 derecha
cm. 0,2x 150



532,00
16 / 0,04

BCC
16000000

BLOCCO COTTURA CARRELLATO COMPOSTO DA: BRS-161, F10T-63ET, PLT-64, TG-64, FTLRT-66ET, PLT-63, HP-4, TS-6

EN Cooking unit on trolley - Made of: BRS-161, F10T-63ET, PLT-64, TG-64, FTLRT-66ET, PLT-63, HP-4, TS-6 • **DE** Kochvorrichtung mit Fahrbarem gestell Anbauteile: BRS-161, F10T-63ET, PLT-64, TG-64, FTLRT-66ET, PLT-63, HP-4, TS-6 • **FR** Bloc cuisson roulant - Elements de composition: BRS-161, F10T-63ET, PLT-64, TG-64, FTLRT-66ET, PLT63, HP-4, TS-6 • **ES** Bloque cocción con ruedas - Compuesto por: BRS-161, F10T-63ET, PLT-64, TG-64, FTLRT-66ET, PLT-63, HP-4, TS-6
cm. 220x 65x 110h



⚡ 15,48 kW **15.958,00**
400V~3N 260 / 2,29
230V~3
50 Hz

NOTE

NOTES / HINWEISE / NOTES / NOTAS

A series of horizontal dotted lines for writing notes.





Tabella					
MOD. SP	INT 1	INT 2	-	MOD. PP	INT 3
SP/630	276		-	PP-630 SX/DX	190
SP/640	376		-	PP-640 SX/DX	290
SP/645	426		-	PP-645 SX/DX	340
SP/650	476		-	PP-650 SX/DX	390
SP/670	676		-	PP-660/PPS-660	490
SP/6105	1026		-	PP-670	590
SP/6110	1076		-	PP-680	690
SP/6125	1226		-	PP-690/PPS-690	790
SP/6135	1326		-	PP-6100	890
SP-SK/660		576	-	PP-6105	940
SP-SK/680		776	-	PP-6110	990
SP-SK/690		876	-	PP-6120	1090
SP-SK/6100		976	-	PP-6125	1140
SP-SK/6120		1176	-	PP-6135	1240
SP-SK/6140		1376	-	PP-6150	1390
SP-SK/6150		1476	-		
SP-SK/6160		1576	-		
SP-SK/6180		1776	-		
SP-SK/6200		1976	-		

CASSETTIERE

MOD. _____
COD. _____

DESCRIZIONE/DESCRIPTION/BEZEICHNUNG/DESCRIPTION/DESCRIPCIÓN
DIMENSIONI/DIMENSIONS/ABMESSUNGEN/DIMENSIONS/DIMENSIONES

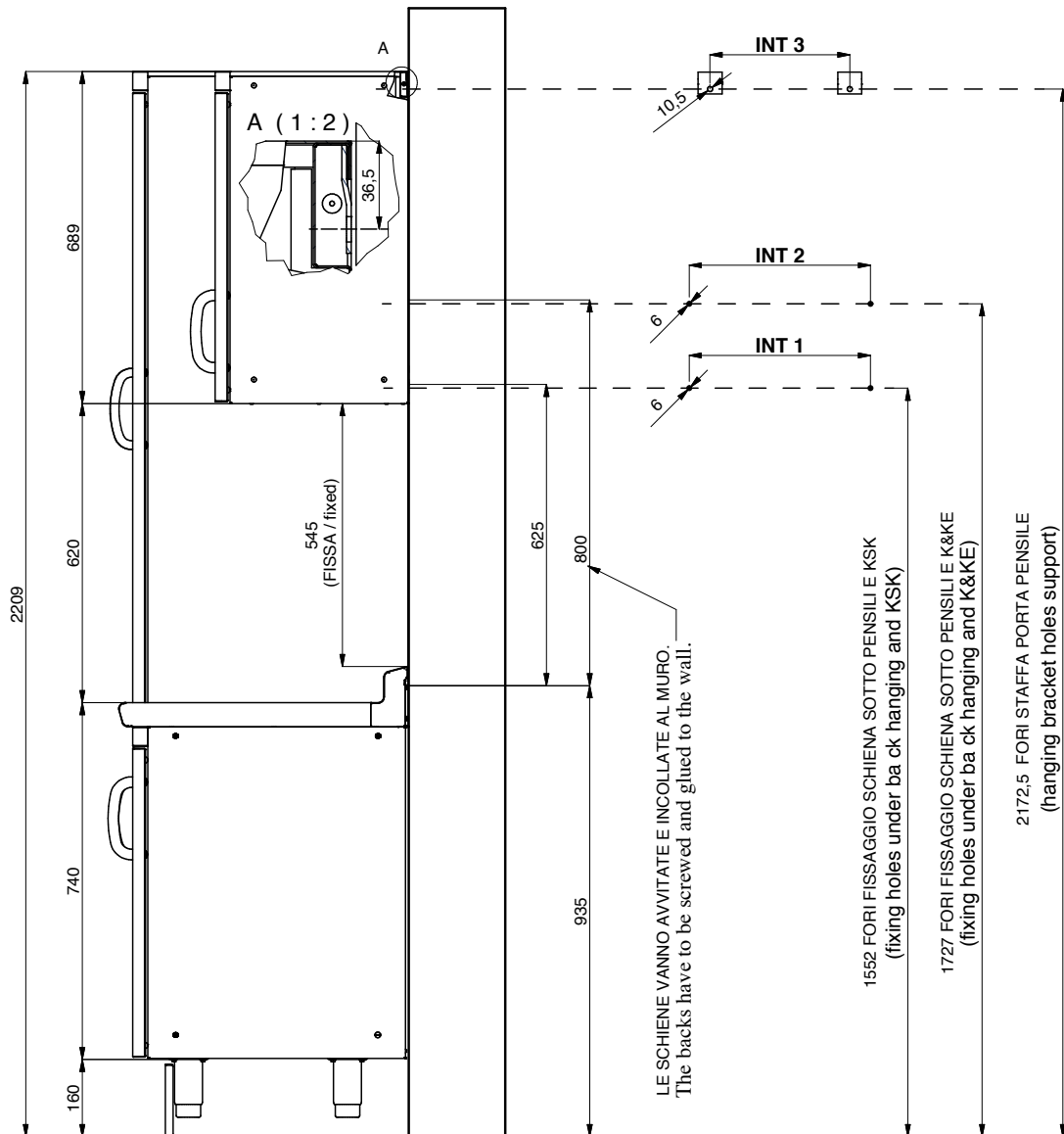
POTENZA/POWER/LEISTUNG/PUISSANCE/POTENCIA
VOLTAGGIO/VOLTAGE/SPANNUNG/VOLTAGE/VOLTAJE

↓ kW kcal/h
↗ kW V~ Hz

PREZZO/PRICE
PREIS/PRIX/PRECIO
KG / M³



BC1/660
01070601

1 CASSETTO CM.51,8X52X57,2
EN 1 DRAWER cm.51,8x52x57,2 • **DE** 1 SCHUBLADEN
cm.51,8x52x57,2 • **FR** 1 TIROIR cm.51,8x52x57,2 • **ES** 1 CAJONE
cm.51,8x52x57,2
cm. 60x 56,6x 81h

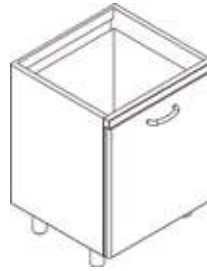

1.302,00
41 / 0,40

BC2/640
01070402

2 CASSETTI CM.31,8X52X25
EN 2 DRAWERS cm.31,8x52x25 • **DE** 2 SCHUBLADEN
cm.31,8x52x25 • **FR** 2 TIROIRS cm.31,8x52x25 • **ES** 2 CAJONES
cm.31,8x52x25
cm. 40x 56,6x 81h

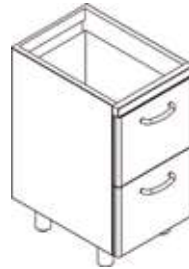

1.218,00
35 / 0,28

BC2/645
01070452

2 CASSETTI CM.36,8X52X25
EN 2 DRAWERS cm.36,8x52x25 • **DE** 2 SCHUBLADEN
cm.36,8x52x25 • **FR** 2 TIROIRS cm.36,8x52x25 • **ES** 2 CAJONES
cm.36,8x52x25
cm. 45x 56,6x 81h



1.344,00
37.5 / 0,31

BC2/650
01070502

2 CASSETTI CM.41,8X52X25
EN 2 DRAWERS cm.41,8x52x25 • **DE** 2 SCHUBLADEN
cm.41,8x52x25 • **FR** 2 TIROIRS cm.41,8x52x25 • **ES** 2 CAJONES
cm.41,8x52x25
cm. 50x 56,6x 81h



1.449,00
40 / 0,34

BC2/660
01070602

2 CASSETTI CM.51,8X52X25
EN 2 DRAWERS cm.51,8x52x25 • **DE** 2 SCHUBLADEN
cm.51,8x52x25 • **FR** 2 TIROIRS cm.51,8x52x25 • **ES** 2 CAJONES
cm.51,8x52x25
cm. 60x 56,6x 81h



1.542,00
44 / 0,40

BC3/640
01070403

3 CASSETTI CM.31,8X52X14,3
EN 3 DRAWERS cm.31,8x52x14,3 • **DE** 3 SCHUBLADEN
cm.31,8x52x14,3 • **FR** 3 TIROIRS cm.31,8x52x14,3 • **ES** 3 CAJONES
cm.31,8x52x14,3
cm. 40x 56,6x 81h



1.262,00
39 / 0,28

BC3/645
01070453

3 CASSETTI CM.36,8X52X14,3
EN 3 DRAWERS cm.36,8x52x14,3 • **DE** 3 SCHUBLADEN
cm.36,8x52x14,3 • **FR** 3 TIROIRS cm.36,8x52x14,3 • **ES** 3 CAJONES
cm.36,8x52x14,3
cm. 45x 56,6x 81h



1.522,00
41.5 / 0,31

BC3/650
01070503

3 CASSETTI CM.41,8X52X14,3
EN 3 DRAWERS cm.41,8x52x14,3 • **DE** 3 SCHUBLADEN
cm.41,8x52x14,3 • **FR** 3 TIROIRS cm.41,8x52x14,3 • **ES** 3 CAJONES
cm.41,8x52x14,3
cm. 50x 56,6x 81h



1.633,00
43 / 0,34

BC4/630
01070304

4 CASSETTI CM.21,8X52X8,9
EN 4 DRAWERS cm.21,8x52x8,9 • **DE** 4 SCHUBLADEN
cm.21,8x52x8,9 • **FR** 4 TIROIRS cm.21,8x52x8,9 • **ES** 4 CAJONES
cm.21,8x52x8,9
cm. 30x 56,6x 81h

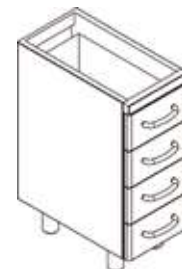

1.344,00
37 / 0,22

CASSETTIERE

MOD. _____
COD. _____

DESCRIZIONE/DESCRIPTION/BEZEICHNUNG/DESCRIPTION/DESCRIPCIÓN
DIMENSIONI/DIMENSIONS/ABMESSUNGEN/DIMENSIONS/DIMENSIONES

POTENZA/POWER/LEISTUNG/PUISSANCE/POTENCIA
VOLTAGGIO/VOLTAGE/SPANNUNG/VOLTAGE/VOLTAJE

⚡ kW kcal/h
⚡ kW V~ Hz

PREZZO/PRICE €
PREIS/PRIX/PRECIO €
KG / M³

BC4/640 4 CASSETTI CM.31,8X52X8,9
01070404 **EN** 4 DRAWERS cm.31,8x52x8,9 • **DE** 4 SCHUBLADEN cm.31,8x52x8,9 • **FR** 4 TIROIRS cm.31,8x52x8,9 • **ES** 4 CAJONES cm.31,8x52x8,9
cm. 40x 56,6x 81h



1.429,00
42 / 0,28

BC4/645 4 CASSETTI CM.36,8X52X8,9
01070454 **EN** 4 DRAWERS cm.36,8x52x8,9 • **DE** 4 SCHUBLADEN cm.36,8x52x8,9 • **FR** 4 TIROIRS cm.36,8x52x8,9 • **ES** 4 CAJONES cm.36,8x52x8,9
cm. 45x 56,6x 81h

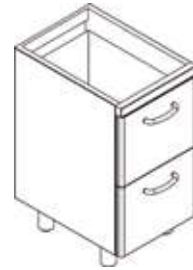

1.702,00
43.5 / 0,31

BC2B/640 2 BACINELLE INOX GN 1/1 H20
01080402 **EN** 2 CONTAINERS INOX GN 1/1 h20 • **DE** 2 BEHALTERN INOX GN 1/1 h20 • **FR** 2 BACS INOX GN 1/1 h20 • **ES** 2 CONTENEDORES INOX GN 1/1 h20
cm. 40x 56,6x 81h

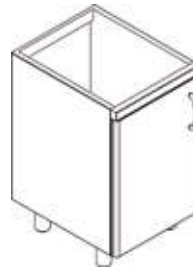

1.369,00
34 / 0,28

BP/630SX BASE CON PORTA E RIPIANO INTERMEDIO
01010301 **EN** STORAGE UNIT WITH DOOR AND MIDDLE SHELF • **DE** FLUGELTURELEMENT MIT ZWISCHENBORD • **FR** ELEMENT DE BASE AVEC PORTE ET ETAGERE INTERMEDIAIRE • **ES** BASE CON PUERTA Y ESTANTE INTERMEDIO
cm. 30x 56,6x 81h

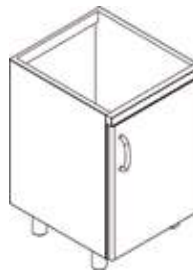

697,00
18 / 0,22

BP/640SX **cm. 40x 56,6x 81h**
01010401

713,00
21 / 0,28

BP/645SX **cm. 45x 56,6x 81h**
01010451

748,00
22.5 / 0,31

BP/650SX **cm. 50x 56,6x 81h**
01010501

758,00
24 / 0,34

BP/630DX **cm. 30x 56,6x 81h**
01010300



697,00
18 / 0,22

BP/640DX **cm. 40x 56,6x 81h**
01010400

713,00
21 / 0,28

BP/645DX **cm. 45x 56,6x 81h**
01010450

748,00
22.5 / 0,31

BP/650DX **cm. 50x 56,6x 81h**
01010500

758,00
24 / 0,34

BP/660 BASE CON PORTE, GUARNIZIONE E RIPIANO INTERMEDIO
01010600 **EN** STORAGE UNIT WITH DOORS , GASKET AND MIDDLE SHELF • **DE** FLUGELTURELEMENT MIT TURDICHTUNG UND ZWISCHENBORD • **FR** ELEMENT DE BASE AVEC PORTES , JOINT ET ETAGERE INTERMEDIAIRE • **ES** BASE CON PUERTAS, GUARNICION Y ESTANTE INTERMEDIO
cm. 60x 56,6x 81h



998,00
28 / 0,40

BP/670 **cm. 70x 56,6x 81h**
01010700

1.036,00
32 / 0,46

MOBILI BASE

MOD. _____
COD. _____





DESCRIZIONE/DESCRIPTION/BEZEICHNUNG/DESCRIPTION/DESCRIPCIÓN
DIMENSIONI/DIMENSIONS/ABMESSUNGEN/DIMENSIONS/DIMENSIONES

POTENZA/POWER/LEISTUNG/PUISSANCE/POTENCIA
VOLTAGGIO/VOLTAGE/SPANNUNG/VOLTAGE/VOLTAJE

↓ kW kcal/h
↑ kW V~ Hz

PREZZO/PRICE
PREIS/PRIX/PRECIO
KG / M³

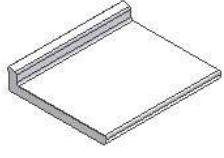
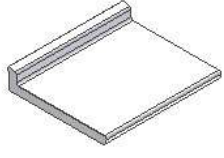

BP/680 01010800	cm. 80x 56,6x 81h		1.082,00 36 / 0,51
BP/690 01010900	cm. 90x 56,6x 81h		1.151,00 39 / 0,57
BP/6100 01011000	cm. 100x 56,6x 81h		1.210,00 42 / 0,63
BP/6105 01011050	BASE CON 3 PORTE, GUARNIZIONI E RIPIANO INTERMEDIO EN STORAGE UNIT WITH 3 DOORS , GASKETS AND MIDDLE SHELF • DE FLUGELTUELEMENT MIT 3 TUREN, TURDICHTUNGEN UND ZWISCHENBORD • FR ELEMENT DE BASE AVEC 3 PORTES , JOINTS ET ETAGERE INTERMEDIAIRE • ES BASE CON 3 PUERTAS, GUARNICION Y ESTANTE INTERMEDIO cm. 105x 56,6x 81h		
BP/6110 01011100	cm. 110x 56,6x 81h		1.469,00 45 / 0,69
BP/6120 01011200	cm. 120x 56,6x 81h		1.522,00 48 / 0,75
BP/6125 01011250	cm. 125x 56,6x 81h		1.550,00 49.5 / 0,78
BP/6135 01011350	cm. 135x 56,6x 81h		1.607,00 52.5 / 0,83
BP/6150 01011500	cm. 150x 56,6x 81h		1.693,00 57 / 0,92
BPA/680 01110801	BASE AD ANGOLO CON PORTA E RIPIANO INTERMEDIO EN CORNER STORAGE UNIT WITH DOOR AND MIDDLE SHELF • DE ECK-ELEMENT 90° MIT TUR UND ZWISCHENBORD • FR ELEMENT DE BASE D'ANGLE AVEC PORTE ET ETAGERE INTERMEDIAIRE • ES BASE ANGULAR CON PUERTA Y ENTANTE INTERMEDIO cm.80/80x 56,6x 81h		
PL/630 01310300	PIANO LAVORO CON ALZATINA E BORDO FRONTALE ARROTONDATO EN WORKTOP WITH RAISED AND REAR BORDER • DE OBERPLATTE MIT AUFKANTUNG HINTEN UND PROFILE ABGERUNDET. • FR PLAN DE TRAVAIL AVEC JOINT DE FINITION POSTERIEUR ET BORDE FRONTAL TOMBE' • ES SOBRE DE TRABAJO CON PETO TRASERO Y BORDE FRONTAL REDONDEADO cm. 30x 60x 5h		196,00 5,5 / 0,05
PL/640 01310400	cm. 40x 60x 5h		224,00 7,5 / 0,06
PL/645 01310450	cm. 45x 60x 5h		252,00 8,5 / 0,07
PL/650 01310500	cm. 50x 60x 5h		266,00 9 / 0,08
PL/660 01310600	cm. 60x 60x 5h		277,00 11 / 0,09

PIANI LAVORO

MOD. _____
COD. _____

DESCRIZIONE/DESCRIPTION/BEZEICHNUNG/DESCRIPTION/DESCRIPCIÓN
DIMENSIONI/DIMENSIONS/ABMESSUNGEN/DIMENSIONS/DIMENSIONES

POTENZA/POWER/LEISTUNG/PUISSANCE/POTENCIA
VOLTAGGIO/VOLTAGE/SPANNUNG/VOLTAGE/VOLTAJE

$\frac{kW}{kcal/h}$ $\frac{V}{Hz}$

PREZZO/PRICE
PREIS/PRIX/PRECIO
KG / M³



PL/670 01310700	cm. 70x 60x 5h		308,00 13 / 0,10
PL/675 01310750	cm. 75x 60x 5h		320,00 13,5 / 0,11
PL/680 01310800	cm. 80x 60x 5h		349,00 14,5 / 0,11
PL/690 01310900	cm. 90x 60x 5h		362,00 16,5 / 0,13
PL/6100 01311000	cm. 100x 60x 5h		377,00 18,5 / 0,14
PL/6105 01311050	cm. 105x 60x 5h		391,00 19,5 / 0,15
PL/6110 01311100	cm. 110x 60x 5h		405,00 20 / 0,15
PL/6120 01311200	cm. 120x 60x 5h		418,00 22 / 0,17
PL/6125 01311250	cm. 125x 60x 5h		434,00 23 / 0,17
PL/6130 01311300	cm. 130x 60x 5h		446,00 24 / 0,18
PL/6135 01311350	cm. 135x 60x 5h		461,00 24,5 / 0,19
PL/6140 01311400	cm. 140x 60x 5h		500,00 25,5 / 0,19
PL/6150 01311500	cm. 150x 60x 5h		531,00 27,5 / 0,21
PL/6160 01311600	cm. 160x 60x 5h		558,00 29,5 / 0,22
PL/6165 01311650	cm. 165x 60x 5h		586,00 30,5 / 0,23
PL/6180 01311800	cm. 180x 60x 5h		628,00 33 / 0,24
PL/6195 01311950	cm. 195x 60x 5h		683,00 35,5 / 0,26
PL/6200 01312000	cm. 200x 60x 5h		711,00 36,5 / 0,27
PL/6210 01312100	cm. 210x 60x 5h		738,00 38,5 / 0,28
PL/6220 01312200	cm. 220x 60x 5h	767,00 40,5 / 0,30	
PL/6225 01312250	cm. 225x 60x 5h	808,00 41,5 / 0,30	
PL/6240 01312400	cm. 240x 60x 5h	863,00 44 / 0,32	

PIANI LAVORO

MOD. _____
COD. _____

DESCRIZIONE/DESCRIPTION/BEZEICHNUNG/DESCRIPTION/DESCRIPCIÓN
DIMENSIONI/DIMENSIONS/ABMESSUNGEN/DIMENSIONS/DIMENSIONES

POTENZA/POWER/LEISTUNG/PUISSANCE/POTENCIA
VOLTAGGIO/VOLTAGE/SPANNUNG/VOLTAGE/VOLTAJE

⚡ kW kcal/h
⚡ kW V~ Hz

PREZZO/PRICE
PREIS/PRIX/PRECIO
KG / M³



PLA/680
01320800

PIANO LAVORO AD ANGOLO CON ALZATINA E BORDO FRONTALE ARROTONDATO

EN CORNER WORKTOP WITH RAISED AND REAR BORDER • **DE** OBERPLATTE ECK-ELEMENT 90° MIT 75mm AUFKANTUNG HINTEN UND PROFILE ABGERUNDET. • **FR** PLAN DE TRAVAIL D'ANGLE AVEC JOINT DE FINITION POSTERIEUR ET BORD FRONTAL TOMBE' • **ES** SOBRE DE TRABAJO ANGULAR CON PETO TRASERO Y BORDE FRONTAL REDONDEADO
cm.80/80x 60x 5h

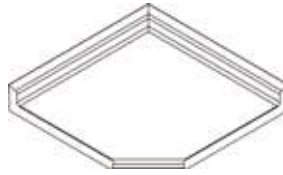

555,00
18 / 0,16

BPL/645SX
01030451

BASE PER LAVELLO CON PORTA

EN STORAGE UNIT FOR SINK WITH DOOR • **DE** FLUGELTURELEMENT FUR SPULBECKEN • **FR** ELEMENT DE BASE POUR EVIER AVEC PORTE • **ES** BASE PARA FREGADERO CON PUERTA
cm. 45x 56,6x 81h

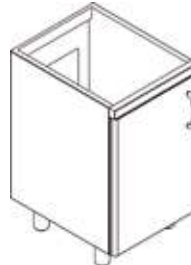

708,00
20.5 / 0,31

BPL/645DX **cm. 45x 56,6x 81h**
01030450

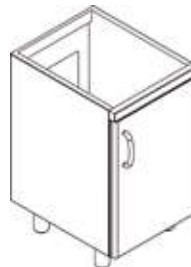

708,00
20.5 / 0,31

BPL/660
01030600

BASE PER LAVELLO CON PORTE

EN STORAGE UNIT FOR SINK WITH 2 DOORS • **DE** FLUGELTURELEMENT FUR SPULBECKEN • **FR** ELEMENT DE BASE POUR EVIER AVEC 2 PORTES • **ES** BASE PARA FREGADERO CON PUERTAS
cm. 60x 56,6x 81h



953,00
26 / 0,40

BPL/690 **cm. 90x 56,6x 81h**
01030900



1.082,00
37 / 0,57

BPL/6105
01031050

BASE PER LAVELLO CON 3 PORTE

EN STORAGE UNIT FOR SINK WITH 3 DOORS • **DE** FLUGELTURELEMENT FUR SPULBECKEN • **FR** ELEMENT DE BASE POUR EVIER AVEC 3 PORTES • **ES** BASE PARA FREGADERO CON 3 PUERTAS
cm. 105x 56,6x 81h



1.121,00
41.5 / 0,66

BPL/6120 **cm. 120x 56,6x 81h**
01031200



1.415,00
45 / 0,75

BPL/6135 **cm. 135x 56,6x 81h**
01031350



1.478,00
49.5 / 0,83

BPL/6150 **cm. 150x 56,6x 81h**
01031500

1.538,00
54 / 0,92

BPAL/680
01130800

BASE PER LAVELLO AD ANGOLO CON PORTA

EN CORNER STORAGE UNIT FOR SINK WITH DOOR • **DE** ECK-ELEMENT 90° FUR ECKSPULABDECKUNG MIT FLUGELTURE • **FR** ELEMENT DE BASE D'ANGLE POUR EVIER AVEC PORTE • **ES** BASE ANGULAR PARA FREGADERO CON PUERTA
cm.80/80x 56,6x 81h



1.395,00
37 / 0,70

MOD. _____
COD. _____

DESCRIZIONE/DESCRIPTION/BEZEICHNUNG/DESCRIPTION/DESCRIPCIÓN
DIMENSIONI/DIMENSIONS/ABMESSUNGEN/DIMENSIONS/DIMENSIONES

POTENZA/POWER/LEISTUNG/PUISSANCE/POTENCIA
VOLTAGGIO/VOLTAGE/SPANNUNG/VOLTAGE/VOLTAJE

⚡ kW kcal/h
⚡ kw V~ Hz

PREZZO/PRICE
PREIS/PRIX/PRECIO
KG / M³



L/645
01330450

1 VASCA CM.29X35X14H
EN 1 BOWL cm.29x35x14h • **DE** 1 BECKEN cm.29x35x14h • **FR** 1 BAC cm.29x35x14h • **ES** 1 CUBA cm.29x35x14h
cm. 45x 60x 5h

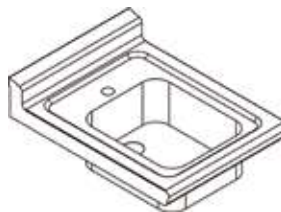

425,00
9.5 / 0,12

L/660
01330600

1 VASCA CM.34X39X19,5H
EN 1 BOWL cm.34x39x19,5h • **DE** 1 BECKEN cm.34x39x19,5h • **FR** 1 BAC cm.34x39x19,5h • **ES** 1 CUBA cm.34x39x19,5h
cm. 60x 60x 5h

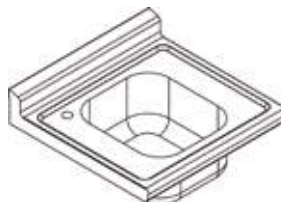

523,00
12 / 0,15

L/691 SX
01330902

1 VASCA SX CM.34X39X19,5H CON SGOCCIOLATOIO
EN 1 BOWL LEFT cm.34x39x19,5h WITH DRAINING BOARD • **DE** 1 BECKEN LINKS cm.34x39x19,5h MIT ABTROPFFLACHE • **FR** 1 BAC A GAUCHE cm.34x39x19,5h AVEC EGOUTTOIR • **ES** 1 CUBA A LA IZQ. cm.34x39x19,5h CON ESCURRIDOR
cm. 90x 60x 5h



635,00
18.5 / 0,22

L/691 DX
01330901

1 VASCA DX CM.34X39X19,5H CON SGOCCIOLATOIO
EN 1 BOWL RIGHT cm.34x39x19,5h WITH DRAINING BOARD • **DE** 1 BECKEN RECHT cm.34x39x19,5h MIT ABTROPFFLACHE • **FR** 1 BAC A DROITE cm.34x39x19,5h AVEC EGOUTTOIR • **ES** 1 CUBA A LA DERECHA cm.34x39x19,5h CON ESCURRIDOR
cm. 90x 60x 5h



635,00
18.5 / 0,22

L/692
01330905

2 VASCHE CM.34X39X19,5H
EN 2 BOWLS cm.34x39x19,5h • **DE** 2 BECKEN cm.34x39x19,5h • **FR** 2 BACS cm.34x39x19,5h • **ES** 2 CUBAS cm.34x39x19,5h
cm. 90x 60x 5h



772,00
18.5 / 0,22

L/6105SX
01331052

1 VASCA SX CM.34X39X19,5H CON SGOCCIOLATOIO
EN 1 BOWL LEFT cm.34x39x19,5h WITH DRAINING BOARD • **DE** 1 BECKEN LINKS cm.34x39x19,5h MIT ABTROPFFLACHE • **FR** 1 BAC A GAUCHE cm.34x39x19,5h AVEC EGOUTTOIR • **ES** 1 CUBA A LA IZQ. cm.34x39x19,5h CON ESCURRIDOR
cm. 105x 60x 5h



698,00
21,5 / 0,25

L/6105DX
01331051

1 VASCA DX CM.34X39X19,5H CON SGOCCIOLATOIO
EN 1 BOWL RIGHT cm.34x39x19,5h WITH DRAINING BOARD • **DE** 1 BECKEN RECHT cm.34x39x19,5h MIT ABTROPFFLACHE • **FR** 1 BAC A DROITE cm.34x39x19,5h AVEC EGOUTTOIR • **ES** 1 CUBA A LA DERECHA cm.34x39x19,5h CON ESCURRIDOR
cm. 105x 60x 5h



698,00
21,5 / 0,25

L/6121SX
01331202

1 VASCA SX CM.34X39X19,5H CON SGOCCIOLATOIO
EN 1 BOWL LEFT cm.34x39x19,5h WITH DRAINING BOARD • **DE** 1 BECKEN LINKS cm.34x39x19,5h MIT ABTROPFFLACHE • **FR** 1 BAC A GAUCHE cm.34x39x19,5h AVEC EGOUTTOIR • **ES** 1 CUBA A LA IZQ. cm.34x39x19,5h CON ESCURRIDOR
cm. 120x 60x 5h



769,00
24 / 0,28

MOD. _____
COD. _____

DESCRIZIONE/DESCRIPTION/BEZEICHNUNG/DESCRIPTION/DESCRIPCIÓN
DIMENSIONI/DIMENSIONS/ABMESSUNGEN/DIMENSIONS/DIMENSIONES

POTENZA/POWER/LEISTUNG/PUISSANCE/POTENCIA
VOLTAGGIO/VOLTAGE/SPANNUNG/VOLTAGE/VOLTAJE

⚡ kW kcal/h
⚡ kw V~ Hz

PREZZO/PRICE
PREIS/PRIX/PRECIO
KG / M³



L/6121DX
01331201

1 VASCA DX CM.34X39X19,5H CON SGOCCIOLATOIO
EN 1 BOWL RIGHT cm.34x39x19,5h WITH DRAINING BOARD • **DE**
1 BECKEN RECHT cm.34x39x19,5h MIT ABTROPFFLACHE • **FR** 1 BAC
A DROITE cm.34x39x19,5h AVEC EGOUTTOIR • **ES** 1 CUBA A LA
DERECHA cm.34x39x19,5h CON ESCURRIDOR
cm. 120x 60x 5h



769,00
24 / 0,28

L/6122SX
01331204

2 VASCHE SX CM.34X39X19,5H CON SGOCCIOLATOIO
EN 2 BOWLS LEFT cm.34x39x19,5h WITH DRAINING BOARD • **DE** 2
BECKEN LINKS cm.34x39x19,5h MIT ABTROPFFLACHE • **FR** 2 BACS A
GAUCHE cm.34x39x19,5h AVEC EGOUTTOIR • **ES** 2 CUBAS A LA IZQ.
cm.34x39x19,5h CON ESCURRIDOR
cm. 120x 60x 5h



912,00
25 / 0,28

L/6122DX
01331203

2 VASCHE DX CM.34X39X19,5H CON SGOCCIOLATOIO
EN 2 BOWLS RIGHT cm.34x39x19,5h WITH DRAINING BOARD • **DE** 2
BECKEN RECHT cm.34x39x19,5h MIT ABTROPFFLACHE • **FR** 2
BACS A DROITE cm.34x39x19,5h AVEC EGOUTTOIR • **ES** 2 CUBAS A
LA DERECHA cm.34x39x19,5h CON ESCURRIDOR
cm. 120x 60x 5h



912,00
25 / 0,28

L/6135SX
01331354

2 VASCHE SX CM.34X39X19,5H CON SGOCCIOLATOIO
EN 2 BOWLS LEFT cm.34x39x19,5h WITH DRAINING BOARD • **DE** 2
BECKEN LINKS cm.34x39x19,5h MIT ABTROPFFLACHE • **FR** 2 BACS A
GAUCHE cm.34x39x19,5h AVEC EGOUTTOIR • **ES** 2 CUBAS A LA IZQ.
cm.34x39x19,5h CON ESCURRIDOR
cm. 135x 60x 5h



978,00
28 / 0,32

L/6135DX
01331353

2 VASCHE DX CM.34X39X19,5H CON SGOCCIOLATOIO
EN 2 BOWLS RIGHT cm.34x39x19,5h WITH DRAINING BOARD • **DE** 2
BECKEN RECHT cm.34x39x19,5h MIT ABTROPFFLACHE • **FR** 2
BACS A DROITE cm.34x39x19,5h AVEC EGOUTTOIR • **ES** 2 CUBAS A
LA DERECHA cm.34x39x19,5h CON ESCURRIDOR
cm. 135x 60x 5h



978,00
28 / 0,32

L/6150SX
01331504

2 VASCHE SX CM.34X39X19,5H CON SGOCCIOLATOIO
EN 2 BOWLS LEFT cm.34x39x19,5h WITH DRAINING BOARD • **DE** 2
BECKEN LINKS cm.34x39x19,5h MIT ABTROPFFLACHE • **FR** 2 BACS A
GAUCHE cm.34x39x19,5h AVEC EGOUTTOIR • **ES** 2 CUBAS A LA IZQ.
cm.34x39x19,5h CON ESCURRIDOR
cm. 150x 60x 5h



1.054,00
30.5 / 0,35

L/6150DX
01331503

2 VASCHE DX CM.34X39X19,5H CON SGOCCIOLATOIO
EN 2 BOWLS RIGHT cm.34x39x19,5h WITH DRAINING BOARD • **DE** 2
BECKEN RECHT cm.34x39x19,5h MIT ABTROPFFLACHE • **FR** 2
BACS A DROITE cm.34x39x19,5h AVEC EGOUTTOIR • **ES** 2 CUBAS A
LA DERECHA cm.34x39x19,5h CON ESCURRIDOR
cm. 150x 60x 5h



1.054,00
30.5 / 0,35

LA/680
01340800

1 VASCA CM.50X40X20H
EN 1 BOWL cm.50x40x20h • **DE** 1 BECKEN cm.50x40x20h • **FR** 1
BAC cm.50x40x20h • **ES** 1 CUBA cm.50x40x20h
cm.80/80x 60x 5h

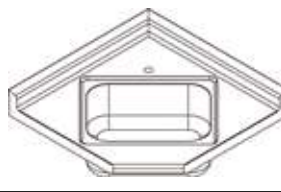

888,00
19 / 0,26

MOD. _____
COD. _____

DESCRIZIONE/DESCRIPTION/BEZEICHNUNG/DESCRIPTION/DESCRIPCIÓN
DIMENSIONI/DIMENSIONS/ABMESSUNGEN/DIMENSIONS/DIMENSIONES

POTENZA/POWER/LEISTUNG/PUISSANCE/POTENCIA
VOLTAGGIO/VOLTAGE/SPANNUNG/VOLTAGE/VOLTAJE

$\frac{kW}{kcal/h}$ $\frac{kW}{V \cdot Hz}$

PREZZO/PRICE
PREIS/PRIX/PRECIO
KG / M³



PP/630SX
01210301

PENSILE CON PORTA E RIPIANO INTERMEDIO
EN WALL UNIT WITH DOOR , AND MIDDLE SHELF • **DE**
WANDHANGESCHRANK MIT TUR , UND ZWISCHENBORD • **FR**
ARMOIRE SUSPENDUE AVEC PORTE ET ETAGERE INTERMEDIAIRE
• **ES** ARMARIO DE PARED CON PUERTA Y ESTANTE INTERMEDIO
cm. 30x 40x 69h

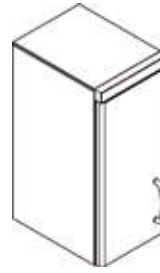

687,00
16 / 0,17

PP/640SX **cm. 40x 40x 69h**
01210401

PP/645SX **cm. 45x 40x 69h**
01210451

PP/650SX **cm. 50x 40x 69h**
01210501

PP/630DX **cm. 30x 40x 69h**
01210300

PP/640DX **cm. 40x 40x 69h**
01210400

PP/645DX **cm. 45x 40x 69h**
01210450

PP/650DX **cm. 50x 40x 69h**
01210500

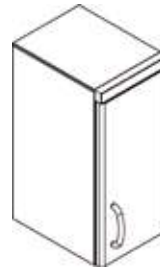

708,00
19 / 0,21

729,00
20.5 / 0,23

750,00
22 / 0,25

687,00
16 / 0,17

708,00
19 / 0,21

729,00
20.5 / 0,23

750,00
22 / 0,25

PP/660
01210600

PENSILE CON PORTE, GUARNIZIONE E RIPIANO INTERMEDIO
EN WALL UNIT WITH DOORS , GASKET AND MIDDLE SHELF • **DE**
WANDHANGESCHRANK MIT TUREN , TURDICHTUNGEN UND
ZWISCHENBORD • **FR** ARMOIRE SUSPENDUE AVEC PORTES, JOINT
DE PORTE ET ETAGERE INTERMEDIAIRE • **ES** ARMARIO DE PARED
CON PUERTAS, GUARNICION Y ESTANTE INTERMEDIO
cm. 60x 40x 69h

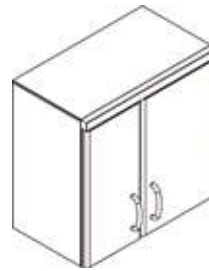

942,00
26 / 0,30

PP/670 **cm. 70x 40x 69h**
01210700

PP/680 **cm. 80x 40x 69h**
01210800

PP/690 **cm. 90x 40x 69h**
01210900

PP/6100 **cm. 100x 40x 69h**
01211000

979,00
29 / 0,34

1.018,00
33 / 0,38

1.076,00
36 / 0,43

1.118,00
39 / 0,47

MOD. _____
COD. _____





DESCRIZIONE/DESCRIPTION/BEZEICHNUNG/DESCRIPTION/DESCRIPCIÓN
DIMENSIONI/DIMENSIONS/ABMESSUNGEN/DIMENSIONS/DIMENSIONES

POTENZA/POWER/LEISTUNG/PUISSANCE/POTENCIA
VOLTAGGIO/VOLTAGE/SPANNUNG/VOLTAGE/VOLTAJE

⚡ kW kcal/h
⚡ kw V~ Hz

PREZZO/PRICE
PREIS/PRIX/PRECIO
KG / M³



PP/6105 01211050	PENSILE CON 3 PORTE, GUARNIZIONI E RIPIANO INTERMEDIO EN WALL UNIT WITH 3 DOORS , GASKET AND MIDDLE SHELF • DE WANDHANGESCHRANK MIT 3 TUREN , TURDICHTUNGEN UND ZWISCHENBORD • FR ARMOIRE SUSPENDUE AVEC 3 PORTES, JOINT DE PORTE ET ETAGERE INTERMEDIAIRE • ES ARMARIO DE PARED CON 3 PUERTAS, GUARNICION Y ESTANTE INTERMEDIO cm. 105x 40x 69h		1.341,00 40.5 / 0,49
PP/6110 01211100	cm. 110x 40x 69h		1.365,00 42 / 0,51
PP/6120 01211200	cm. 120x 40x 69h		1.406,00 45 / 0,56
PP/6125 01211250	cm. 125x 40x 69h		1.429,00 46.5 / 0,58
PP/6135 01211350	cm. 135x 40x 69h		1.507,00 49.5 / 0,62
PP/6150 01211500	cm. 150x 40x 69h		1.588,00 53 / 0,69
PPS/660 01230600	PENSILE SCOLAPIATTI CON PORTE, GUARNIZIONE E PORTAPIATTI EN WALL UNIT PLATE RACK WITH DOORS, GASKETS AND PLATE RACK • DE WANDHANGESCHRANK FUR TELLER MIT FLUGELTUREN UND TURDICHTUNGEN • FR ARMOIRE EGOUTTOIR SUSPENDUE AVEC PORTES JOINTS DE PORTE, GRILLE INTERMEDIAIRE PORTE-ASSIETTES • ES ARMARIO DE PARED ESCURRIDOR CON PUERTA Y GUARNICION cm. 60x 40x 69h		1.180,00 26 / 0,30
PPS/690 01230900	cm. 90x 40x 69h		1.293,00 34 / 0,43
PPA/680 01260801	PENSILE AD ANGOLO CON PORTA E RIPIANO INTERMEDIO EN CORNER WALL UNIT WITH DOOR AND MIDDLE SHELF • DE ECK-WANDHANGESCHRANK MIT FLUGELTURE UND ZWISCHENBORD • FR ARMOIRE D'ANGLE SUSPENDUE AVEC 2 PORTES ET ETAGERE INTERMEDIAIRE • ES ARMARIO ANGULAR DE PARED CON PUERTA Y ESTANTE INTERMEDIO cm.80/80x 40x 69h		1.571,00 38 / 0,70
PPV/630SX 01220301	PENSILE CON PORTA VETRO E RIPIANO INTERMEDIO EN WALL UNIT WITH GLASS DOOR AND MIDDLE SHELF • DE WANDHANGESCHRANK MIT GLASTUR UND ZWISCHENBORD • FR ARMOIRE SUSPENDUE AVEC PORTE VITREE ET ETAGERE INTERMEDIAIRE • ES ARMARIO DE PARED CON PUERTA VIDRIERA Y ESTANTE INTERMEDIO cm. 30x 40x 69h		760,00 16.5 / 0,17
PPV/645SX 01220451	cm. 45x 40x 69h		836,00 21 / 0,23



PPV/630DX cm. 30x 40x 69h
01220300

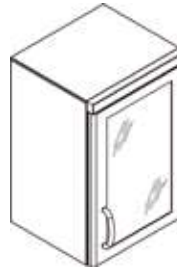

760,00
16.5 / 0,17

PPV/645DX cm. 45x 40x 69h
01220450

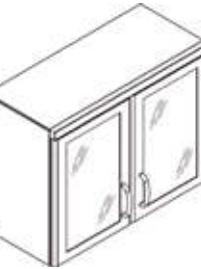

836,00
21 / 0,23

PPV/660 **PENSILE CON PORTE VETRO, GUARNIZIONE E RIPIANO INTERMEDIO**
01220600

EN WALL UNIT WITH GLASS DOORS, GASKET AND MIDDLE SHELF
• **DE** WANDHANGESCHRANK MIT 2 GLASTURE, TURDICHTUNG UND ZWISCHENBORD • **FR** ARMOIRE SUSPENDUE AVEC 2 PORTES VITREE , JOINT DE PORTE ET ETAGERE INTERMEDIAIRE • **ES** ARMARIO DE PARED CON PUERTAS VIDRIERA, GUARNICION Y ESTANTE INTERMEDIO
cm. 60x 40x 69h

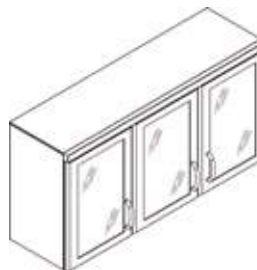

1.070,00
27 / 0,30

PPV/690 cm. 90x 40x 69h
01220900

1.279,00
37 / 0,43

PPV/6105 **PENSILE CON 3 PORTE VETRO, GUARNIZIONI E RIPIANO INTERMEDIO**
01221050

EN WALL UNIT WITH 3 GLASS DOORS, GASKETS AND MIDDLE SHELF
• **DE** WANDHANGESCHRANK MIT 3 GLASTURE, TURDICHTUNG UND ZWISCHENBORD • **FR** ARMOIRE SUSPENDUE AVEC 3 PORTES VITREE , JOINT DE PORTE ET ETAGERE INTERMEDIAIRE • **ES** ARMARIO DE PARED CON 3 PUERTAS VIDRIERA, GUARNICION Y ESTANTE INTERMEDIO
cm. 105x 40x 69h

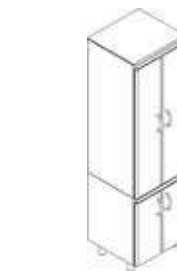

1.570,00
42 / 0,49

PPV/6135 cm. 135x 40x 69h
01221350

1.809,00
51 / 0,62

A/660 **ARMADIO CON PORTE, GUARNIZIONI E 4 RIPIANI INTERMEDI**
01160600

EN TWIN UNIT WITH DOORS, GASKET AND 4 MIDDLE SHELVES
• **DE** HOCHSCHRANK MIT TUREN, TURDICHTUNGEN UND 4 ZWISCHENBORDE • **FR** ARMOIRE A PORTES, JOINT DE PORTE ET 4 ETAGERES INTERMEDIAIRES • **ES** ARMARIO CON PUERTAS, GUARNICIONES Y 4 ESTANTES INTERMEDIOS
cm. 60x 60x 220h

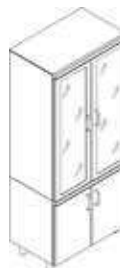

2.395,00
70 / 1,07

A/690 cm. 90x 60x 220h
01160900

2.875,00
99 / 1,52

AV/660 **ARMADIO CON PORTE VETRO, GUARNIZIONI E 4 RIPIANI INTERMEDI**
01170600

EN TWIN UNIT WITH GLASS DOORS, GASKETS AND 4 MIDDLE SHELVES • **DE** HOCHSCHRANK MIT 4 GLASTUREN, TURDICHTUNGEN UND 4 ZWISCHENBORDE • **FR** ARMOIRE AVEC PORTES VITREE, JOINTES DE PORTE ET 4 ETAGERES INTERMEDIAIRES • **ES** ARMARIO CON PUERTAS VIDRIERA, GUARNICIONES Y 4 ESTANTES INTERMEDIOS
cm. 60x 60x 220h

AV/690 cm. 90x 60x 220h
01170900

3.075,00
102 / 1,52

MOD. _____
COD. _____

DESCRIZIONE/DESCRIPTION/BEZEICHNUNG/DESCRIPTION/DESCRIPCIÓN
DIMENSIONI/DIMENSIONS/ABMESSUNGEN/DIMENSIONS/DIMENSIONES

POTENZA/POWER/LEISTUNG/PUISSANCE/POTENCIA
VOLTAGGIO/VOLTAGE/SPANNUNG/VOLTAGE/VOLTAJE

⚡ kW _____
kcal/h _____
⚡ kw _____
V~ _____
Hz _____

PREZZO/PRICE
PREIS/PRIX/PRECIO
KG / M³



KSK/660
01280600

CAPPA STILE CON PARETE E MENSOLA, ASPIRAZIONE AUTOFILTRANTE E CARBONI ATTIVI, 2 VELOCITA' E LUCE
EN SELF-FILTER EXTRACTOR HOOD WITH WALL AND BRACKET, ACTIVATED CHARCOAL, 2 SPEED MOTOR AND LIGHT. • **DE** SELBSTFILTRIERENDE ABZUGSHAUBE MIT KOHLEAKTIVFILTERN, 2-STUFEN GEBLASE, BELEUCHTUNG, WANDVERKLEIDUNG UND KONSOLLE. • **FR** HOTTE D'ASPIRATION DE STYLE AUTOFILTRANTE, AU CHARBON ACTIF, MOTEUR 2 VITESSES, LUMIERE, PAROIR ET ATAGERE • **ES** CAMPANA EXTRACTORA CON PARED Y REPISA, CON ASPIRACION AUTOFILTRANTE Y CARBONES ACTIVOS, 2 VELOCIDADES Y LUZ.
cm. 60x 60x 70h

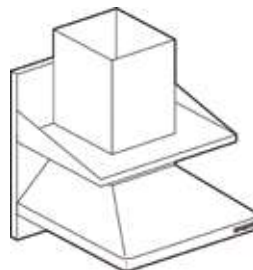

⚡ 0,22 KW _____ **1.485,00**
230V~ _____ 23 / 0,41
50 Hz _____

KSK/690
01280900

cm. 90x 60x 70h

⚡ 0,22 KW _____ **1.727,00**
230V~ _____ 32 / 0,60
50 Hz _____

KSK/6100
01281000

cm. 100x 60x 70h

⚡ 0,22 KW _____ **2.002,00**
230V~ _____ 33 / 0,67
50 Hz _____

SP/630
01400300

SCHIENA SOTTO PENSILI
EN SPLASH BACK FOR WALL UNIT • **DE** RUCKWAND FÜR HOCHSCHRANK • **FR** FINITION DOS POUR ARMOIRES SUSPENDUE • **ES** ESPALDA DEBAJO DE ARMADIO DE PARED
cm. 30x 0,2x 62,5h



79,00
1.3 / 0,00

SP/640
01400400

cm. 40x 0,2x 62,5h

104,00
1.8 / 0,01

SP/645
01400450

cm. 45x 0,2x 62,5h

118,00
2 / 0,01

SP/650
01400500

cm. 50x 0,2x 62,5h

129,00
2.2 / 0,01

SP/670
01400700

cm. 70x 0,2x 62,5h

166,00
3.1 / 0,01

SP-SK/680
01400800

cm. 80x 0,2x 80h

189,00
4.5 / 0,01

SP/6105
01401050

cm. 105x 0,2x 62,5h

246,00
4.6 / 0,01

SP/6110
01401100

cm. 110x 0,2x 62,5h

257,00
4.8 / 0,02

SP-SK/6120
01401200

cm. 120x 0,2x 80h

280,00
6.7 / 0,02

SP/6125
01401250

cm. 125x 0,2x 62,5h

293,00
5.5 / 0,02

SP/6135
01401350

cm. 135x 0,2x 62,5h

317,00
5.9 / 0,02

SP-SK/6150
01401500

cm. 150x 0,2x 80h

351,00
8.4 / 0,03

ACCESSORI

MOD. _____
COD. _____

DESCRIZIONE/DESCRIPTION/BEZEICHNUNG/DESCRIPTION/DESCRIPCIÓN
DIMENSIONI/DIMENSIONS/ABMESSUNGEN/DIMENSIONS/DIMENSIONES

POTENZA/POWER/LEISTUNG/PUISSANCE/POTENCIA
VOLTAGGIO/VOLTAGE/SPANNUNG/VOLTAGE/VOLTAJE

⚡ kW kcal/h
⚡ kW V~ Hz

PREZZO/PRICE
PREIS/PRIX/PRECIO
KG / M³



SP-SK/660
01400600

SCHIENA SOTTO PENSILI E CAPPE KSK
EN SPLASH BACK FOR WALL UNIT AND HOOD KSK • **DE**
RÜCKWAND FÜR HOCHSCHRANK UND HAUBE KSK • **FR** FINITION
DOS POUR ARMOIRES SUSPENDUE ET HOTTE KSK • **ES** ESPALDA
DEBAJO DE ARMADIO DE PARED Y CAMPANA KSK
cm. **60x 0,2x 80h**



141,00
3.4 / 0,01

SP-SK/690 cm. **90x 0,2x 80h**
01400900

209,00
5 / 0,02

SP-SK/6100 cm. **100x 0,2x 80h**
01401000

234,00
5.6 / 0,02

ZB
01410000

ZOCCOLATURA BASE
EN FRONT PLINTH • **DE** GRUNDSOCKEL • **FR** PLINTHE FRONTAL
• **ES** ZOCOLOS BASE
€/m x cm. **15h**

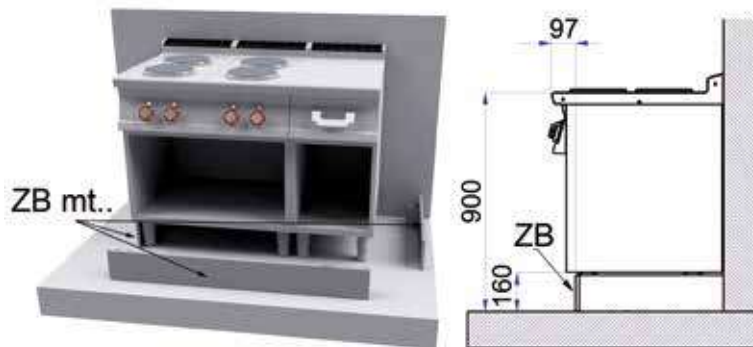

143,00
/

ZA
01410002

ZOCCOLATURA ANGOLO
EN CORNER PLINTH • **DE** EKE-SOCKEL • **FR** PLINTHE ANGLE • **ES**
ZOCOLOS ANGULAR
cm. **15h**

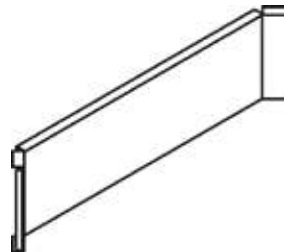

86,00
0.3 / 0,01

PC PP/630
01430300

PROTEZIONE CAVO FARETTO
EN CABLE PROTECTION OF SMALL LAMP • **DE** SCHUTZKABEL
VOM SCHEINWERFER • **FR** PROTECTION CABLE POUR LAMP • **ES**
PROTECCION CABLE PUNTO DE LUZ
cm. **30x 1,2x 2,9h**



22,00
/ 0,00

PC PP/640 cm. **40x 1,2x 2,9h**
01430400

27,00
/ 0,00

PC PP/645 cm. **45x 1,2x 2,9h**
01430450

30,00
/ 0,00

PC PP/650 cm. **50x 1,2x 2,9h**
01430500

32,00
/ 0,00

PC PP/660 cm. **60x 1,2x 2,9h**
01430600

42,00
/ 0,00

PC PP/670 cm. **70x 1,2x 2,9h**
01430700

45,00
/ 0,00

ACCESSORI

MOD. _____
COD. _____

DESCRIZIONE/DESCRIPTION/BEZEICHNUNG/DESCRIPTION/DESCRIPCIÓN
DIMENSIONI/DIMENSIONS/ABMESSUNGEN/DIMENSIONS/DIMENSIONES

POTENZA/POWER/LEISTUNG/PUISSANCE/POTENCIA
VOLTAGGIO/VOLTAGE/SPANNUNG/VOLTAGE/VOLTAJE

⚡ kW kcal/h ⚡ kw V~ Hz

PREZZO/PRICE PREIS/PRIX/PRECIO
KG / M³



PC PP/680 cm. 80x 1,2x 2,9h
01430800



53,00
/ 0,00

PC PP/690 cm. 90x 1,2x 2,9h
01430900

56,00
/ 0,00

PC PP/6100 cm. 100x 1,2x 2,9h
01431000

59,00
/ 0,00

PC PP/6105 cm. 105x 1,2x 2,9h
01431050

68,00
/ 0,00

PC PP/6110 cm. 110x 1,2x 2,9h
01431100

71,00
/ 0,00

PC PP/6120 cm. 120x 1,2x 2,9h
01431200

83,00
/ 0,00

PC PP/6125 cm. 125x 1,2x 2,9h
01431250

90,00
/ 0,00

PC PP/6135 cm. 135x 1,2x 2,9h
01431350

98,00
/ 0,00

PC PP/6150 cm. 150x 1,2x 2,9h
01431500

106,00
/ 0,00

KIT FARETTO **KIT FARETTO LED 1,3W L2000 (FARETTO,GHIERA,STAFFA)**
01420000 **EN** KIT SMALL LAMP LED 1,3W L2000 • **DE** KIT SCHEINWERFER LED 1,3W L2000 • **FR** KIT LAMPE LED 1,3W L2000 • **ES** PUNTO DE LUZ LED 1,3W L2000



⚡ 0,001 KW
12V~
50/60 Hz

157,00
/ 0,00

TRASFORMATORE **TRASFORMATORE 230V-12V MAX 6 INGRESSI LED**
01420001 **EN** TRANSFORMER 230V-12V MAX 6 LED • **DE** VERWANDLER 230V-12V MAX 6 LED • **FR** TRASFORMATEUR 230V-12V MAX 6 LED • **ES** TRANSFORMADOR DE CORRIENTE 230V-12V MAX 6 LED

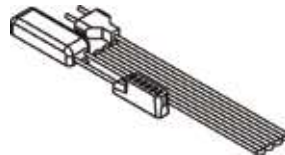

86,00
/ 0,00

PROLUNGA BT **PROLUNGA 12V L1500**
01420002 **EN** EXTENSION 12V-L1500 • **DE** FORTSATZT 12V L1500 • **FR** RALLONGE 12V L1500 • **ES** EXTENSIÓN 12V L1500



48,00
/ 1,00

EROS4 **GRUPPO RUBINETTO DOCCIA A LEVA**
_EROS004 **EN** TAP FOR SINK WITH SHOWER • **DE** MISCHBATTERIE • **FR** GROUPE ROBINET AVEC DOUCHE • **ES** GRUPO GRIFO CON DUCHA
cm. 27x 45h



245,00
2 / 0,01

ACCESSORI

MOD. _____
COD. _____

DESCRIZIONE/DESCRIPTION/BEZEICHNUNG/DESCRIPTION/DESCRIPCIÓN
DIMENSIONI/DIMENSIONS/ABMESSUNGEN/DIMENSIONS/DIMENSIONES

POTENZA/POWER/LEISTUNG/PUISSANCE/POTENCIA
VOLTAGGIO/VOLTAGE/SPANNUNG/VOLTAGE/VOLTAGE

$\frac{kW}{kcal/h}$ $\frac{V}{Hz}$

PREZZO/PRICE
PREIS/PRIX/PRECIO
KG / M³



GL
51262000

GRUPPO RUBINETTO A LEVA, A NORME IGENICHE
EN LEVER TAP FOR SINK IN ACCORDANCE WITH SANITARY
REGULATIONS • **DE** EINHEBEL-MISCHBATTERIE • **FR** GROUPE
ROBINET A LEVIER, AUX NORMES HYGIENIQUES • **ES** GRUPO GRIFO
CON PALANCA SEGUN NORMAS HIGIENICAS
cm. 21x 24h



108,00
1 / 0,00

SER
01440000

KIT SERRATURA CON CHIAVE PER PORTA
EN KIT LOCK WITH KEYS FOR DOOR • **DE** KIT SCHLOSS KT
SCHLUSSEL FUR TUR • **FR** SERRURE AVEC CLES POUR PORTE • **ES**
CERRADURA CON LLAVE PARA PUERTA



59,00
/

MAGIC PROF 65



BAGNOMARIA ELETTRICI

MOD. _____
COD. _____

DESCRIZIONE/DESCRIPTION/BEZEICHNUNG/DESCRIPTION/DESCRIPCIÓN
DIMENSIONI/DIMENSIONS/ABMESSUNGEN/DIMENSIONS/DIMENSIONES

POTENZA/POWER/LEISTUNG/PUISSANCE/POTENCIA
VOLTAGGIO/VOLTAGE/SPANNUNG/VOLTAGE/VOLTAJE

⚡ kW kcal/h
⚡ kw V~ Hz

PREZZO/PRICE
PREIS/PRIX/PRECIO
KG / M³



BM-4EM
07050410

BAGNOMARIA MONOFASE VASCA PER GN 1/1 H.15
EN Bain marie singlephase - Bowl for GN 1/1 h.15 • **DE** Wasserbäder einphasig - Becken GN 1/1 h.15 • **FR** Bain marie monophasé - Cuve GN 1/1 h.15 • **ES** Baño de maría monofásico - Cuba para GN 1/1 15h
cm. 40x 65x 29h



⚡ 2,1 kW 1.119,00
230V~ 21 / 0,18
50/60 Hz

BM-6EM
07050610

BAGNOMARIA MONOFASE VASCA PER 1 GN 1/1 + 2 GN 1/4 H.15
EN Bain marie singlephase - Bowl for 1 GN 1/1 + 2 GN 1/4 h.15
• **DE** Wasserbäder einphasig - Becken für 1 GN 1/1 + 2 GN 1/4 h.15
• **FR** Bain-marie monophasé - Cuve pour 1 GN 1/1 + 2 GN 1/4 h.15
• **ES** Baño de maría monofásico - Cuba para 1 GN 1/1 + 2 GN 1/4 15h
cm. 60x 65x 29h

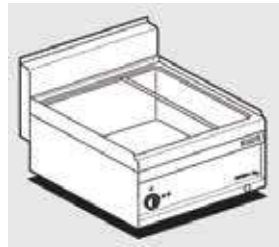

⚡ 3,15 kW 1.358,00
230V~ 27 / 0,27
50/60 Hz

BM-4G
07220450

BAGNOMARIA GAS - VASCA PER GN 1/1 H.15
EN Gas bain-marie - Bowl for GN 1/1 h.15 • **DE** Gas Wasserbad - Becken für GN 1/1 h.15 • **FR** Bain-marie gaz - Cuve pour GN 1/1 h.15
• **ES** Baño de maría gas - Cuba para GN 1/1 h.15
cm. 40x 65x 29h



⚡ 3,5 kW 1.441,00
3.010 kcal/h 27 / 0,18

BM-6G
07220650

BAGNOMARIA GAS VASCA PER GN 1/1 + 2 GN 1/4, H.15
EN Gas bain-marie - Bowl for GN 1/1 + 2 GN 1/4, h.15 • **DE** Gas Wasserbad - Becken für GN 1/1 + 2 GN 1/4, h.15 • **FR** Bain-marie gaz - Cuve pour GN 1/1 + 2 GN 1/4, h.15 • **ES** Baño de maría gas - Cuba para GN 1/1 + 2 GN 1/4, h.15
cm. 60x 65x 29h



⚡ 5 kW 1.861,00
4.300 kcal/h 33 / 0,27

BS-4EM
07040410

CONTENITORE CALDO MONOFASE VASCA CM. 30,5X51X16,5H CON FALSO FONDO FORATO.
EN Fry dump singlephase Bowl cm. 30,5x51x16,5h with perforated bottom. • **DE** Frittenwanne einphasig Becke cm. 30,5x51x16,5h mit gelochtem Bodenrost. • **FR** Silo à frites monophasé Cuve cm 30,5x51x16,5h avec double-fond perforé • **ES** Recipiente caliente monofásico Cuba cm. 30,5x51x16,5h con falso fondo agujereado
cm. 40x 65x 29h



⚡ 0,82 kW 1.043,00
230V~ 21.5 / 0,18
50/60 Hz

RI-4EM
07040411

RISCALDANTE INFRAROSSO MONOFASE
EN Infra-red heater singlephase • **DE** Infrarot-Strahler einphasig • **FR** Lampe chauffante à infrarouge monophasé • **ES** Calentador infrarrojo monofásico
cm. 39x 50x 37h



⚡ 0,33 kW 768,00
230V~ 8 / 0,10
50/60 Hz

PIANI COTTURA ELETTRICI

MOD. _____
COD. _____

DESCRIZIONE/DESCRIPTION/BEZEICHNUNG/DESCRIPTION/DESCRIPCIÓN
DIMENSIONI/DIMENSIONS/ABMESSUNGEN/DIMENSIONS/DIMENSIONES

POTENZA/POWER/LEISTUNG/PUISSANCE/POTENCIA
VOLTAGGIO/VOLTAGE/SPANNUNG/VOLTAGE/VOLTAJE

⚡ kW kcal/h
V~ Hz

PREZZO/PRICE
PREIS/PRIX/PRECIO
KG / M³



PC-4ET
07030430

PIANO COTTURA TRIFASE N. 2 PIASTRE
EN Boiling unit - N. 2 plates • **DE** Kochplatte - N. 2 Kochplatten • **FR** Rechaud - N. 2 plaques • **ES** Sobre de cocción - N. 2 planchas
cm. 40x 65x 29h



⚡ 4 kW 847,00
400V~2N 25.5 / 0,18
230V~3
230V~
50/60 Hz

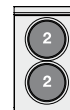

PC-6ET
07030630

PIANO COTTURA TRIFASE N. 4 PIASTRE
EN Boiling unit - N. 4 plates • **DE** Kochplatte - N. 4 Kochplatten • **FR** Rechaud - N. 4 plaques • **ES** Sobre de cocción - N. 4 planchas
cm. 60x 65x 29h



⚡ 7,5 kW 1.519,00
400V~3N 37 / 0,27
230V~3
230V~
50/60 Hz

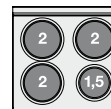

PC-4G
07210450

PIANO COTTURA GAS 2 FUOCHI
EN Gas heated boiling unit - 2 burners • **DE** Gas-Kochplatte - 2 Kochstellen • **FR** Rechaud gaz - 2 Feux vifs • **ES** Sobres de cocción gas - 2 quemadores
cm. 40x 65x 29h



⚡ 9 kW 1.228,00
7.740 kcal/h 44 / 0,18

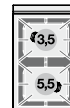

PC-8G
07210850

PIANO COTTURA GAS 4 FUOCHI
EN Gas heated boiling unit - 4 burners • **DE** Gas-Kochplatte - 4 Kochstellen • **FR** Rechaud gaz - 4 Feux vifs • **ES** Sobres de cocción gas - 4 quemadores
cm. 80x 65x 29h



⚡ 18 kW 1.885,00
15.480 kcal/h 60.5 / 0,35

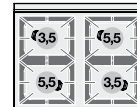

PCC-4ET
07110430

PIANO COTTURA VETROCERAMICA TRIFASE 2 PIASTRE - VETRO: CM. 36X52
EN Boiling unit ceramic glass threephase, 2 plates. Glass: cm. 36x52
• **DE** Kochplatte ceran-kochfläche dreiphasig, 2 Kochplatten. Kochfläche: cm. 36x52 • **FR** Rechaud triphase vitroceramique, 2 foyers. Vitre: cm. 36x52 • **ES** Sobres de cocción vitrocerámica trifásico, 2 planchas. Vidrio: 36x52 cm
cm. 40x 65x 29h



⚡ 3,6 kW 1.942,00
400V~2N 23.5 / 0,18
230V~3
230V~
50/60 Hz



PIANI COTTURA ELETTRICI

MOD. _____
COD. _____

DESCRIZIONE/DESCRIPTION/BEZEICHNUNG/DESCRIPTION/DESCRIPCIÓN
DIMENSIONI/DIMENSIONS/ABMESSUNGEN/DIMENSIONS/DIMENSIONES

POTENZA/POWER/LEISTUNG/PUISSANCE/POTENCIA
VOLTAGGIO/VOLTAGE/SPANNUNG/VOLTAGE/VOLTAJE

⚡ kW kcal/h
⚡ kW V~ Hz

PREZZO/PRICE
PREIS/PRIX/PRECIO
KG / M³



PCC-6ET
07110630

PIANO COTTURA VETROCERAMICA TRIFASE 4 PIASTRE - VETRO: CM. 56X52

EN Boiling unit ceramic glass threephase, 4 plates. Glass: cm. 56x52
• **DE** Kochplatte Ceran-Kochfläche dreiphasig, 4 Kochplatten.
Kochfläche: cm. 56x52 • **FR** Rechaud triphase vitrocéramique, 4 foyers.
Vitro: cm. 56x52 • **ES** Sobres de cocción vitrocerámica trifásico, 4
planchas. Vidrio: 56x52 cm
cm. 60x 65x 29h



⚡ 7,2 kW **2.933,00**
400V~3N 32 / 0,27
230V~3
230V~
50/60 Hz

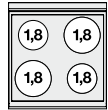

BR-6ET
07070630

BRASIERA TRIFASE - LT. 20 - VASCA CM. 50,5X41X10H

EN Bratt-pan threephase - Cap. 20 litres - Pan cm. 50,5x41x10h • **DE**
Bratpfanne dreiphasig lt. 20 - Becken cm. 50,5x41x10h • **FR** Sauteuse
triphase capacité 20 lt. Cuve cm. 50,5x41x10h • **ES** Sartén trifásica 20
lt. - Cuba cm. 50,5x41x10h
cm. 60x 65x 29h



⚡ 6 kW **1.883,00**
400V~3N 47 / 0,27
230V~3
50/60 Hz

BR-6G
07240650

BRASIERA GAS LT. 20 - VASCA CM. 50,5X41X10H

EN Gas bratt-pan - Capacity 20 litres - Pan cm. 50,5x41x10 h • **DE**
Gas Bratpfanne - lt. 20 - Becken cm. 50,5x41x10 h • **FR** Sauteuse
gaz - lt. 20 - Bac cm. 50,5x41x10h • **ES** Sartén gas - 20 l. - Cuba cm.
50,5x41x10h
cm. 60x 65x 29h



⚡ 6,9 kW **2.446,00**
5.930 kcal/h 46 / 0,27

CF4-8ET
07660830

CUCINA ELETTRICA CON 4 PIASTRE FORNO ELETTRICO MULTIFUNZIONE CAMERA CM. 64X37X35H, TEMP: 50÷250°C, CON 1 GRIGLIA CM.53X32,5 GN1/1 - PORTA VETRO

EN Range N. 4 plates Multifunction electric oven Chamber cm.
64x37x35h, temp: 50÷250°C ,with 1 grid cm.53x32,5 GN1/1 - Glass
door • **DE** Elektroherd N. 4 Kochplatten Multifunktions-Elektroofen cm.
64x37x35h, temp: 50÷250°C ,with 1 grid cm.53x32,5 GN1/1 - Glastür
• **FR** Cuisinière - N. 4 plaques Four électrique à fonctions multiples
cm. 64x37x35h, temp: 50÷250°C ,avec 1 grille cm.53x32,5 GN1/1 -
Porte vitrée • **ES** Cocina N. 4 planchas Horno eléctrico multifuncional
- Cámara cm. 64x37x35h, temp: 50÷250°C ,con 1 parilla cm.53x32,5
GN1/1 - Puerta vidrio
cm. 80x 65x 87h



⚡ 11,11 kW **3.528,00**
400V~3N 95 / 0,78
230V~3
50/60 Hz

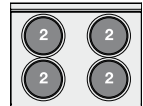

CF4-8ET
07660831

CUCINA ELETTRICA CON 4 PIASTRE FORNO ELETTRICO MULTIFUNZIONE CAMERA CM. 64X37X35H, TEMP: 50÷250°C, CON 1 GRIGLIA CM.53X32,5 GN1/1 - PORTA CIECA INOX

EN Range N. 4 plates Multifunction electric oven Chamber cm.
64x37x35h, temp: 50÷250°C ,with 1 grid cm.53x32,5 GN1/1 - Stainless
steel door • **DE** Elektroherd N. 4 Kochplatten Multifunktions-Elektroofen
cm. 64x37x35h, temp: 50÷250°C ,with 1 grid cm.53x32,5 GN1/1 -
Edelstahltür • **FR** Cuisinière - N. 4 plaques Four électrique à fonctions
multiples cm. 64x37x35h, temp: 50÷250°C ,avec 1 grille cm.53x32,5
GN1/1 - Porte acier inoxydable • **ES** Cocina N. 4 planchas Horno
eléctrico multifuncional - Cámara cm. 64x37x35h, temp: 50÷250°C ,con
1 parilla cm.53x32,5 GN1/1 - Puerta ciega inox
cm. 80x 65x 87h



⚡ 11,11 kW **3.528,00**
400V~3N 95 / 0,78
230V~3
50/60 Hz

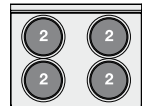

CUCINE ELETTRICHE

MOD. _____
COD. _____

DESCRIZIONE/DESCRIPTION/BEZEICHNUNG/DESCRIPTION/DESCRIPCIÓN
DIMENSIONI/DIMENSIONS/ABMESSUNGEN/DIMENSIONS/DIMENSIONES

POTENZA/POWER/LEISTUNG/PUISSANCE/POTENCIA
VOLTAGGIO/VOLTAGE/SPANNUNG/VOLTAGE/VOLTAJE

⚡ kW _____
kcal/h _____
V~ _____
Hz _____

PREZZO/PRICE
PREIS/PRIX/PRECIO
KG / M³



CF4-8ETS
07660832

CUCINA ELETTRICA CON N. 4 PIASTRE - FORNO ELETTRICO STATICO C/GRILL CM. 64X42X35H, TEMP: 50÷250°C, CON 1 GRIGLIA CM.53X32,5 GN1/1 - PORTA VETRO
EN Range N. 4 plates - Static oven with grill cm. 64x42x35h, temp: 50÷250°C ,with 1 grid cm.53x32,5 GN1/1 - Glass door • DE Elektroherd N. 4 Kochplatten Statischer Ofen mit Grill cm. 64x42x35h, temp: 50÷250°C ,with 1 grid cm.53x32,5 GN1/1 - Glastür • FR Cuisinière N. 4 plaques - Four statique avec grill cm. 64x42x35h, temp: 50÷250°C ,mit 1 Rost cm.53x32,5 GN1/1 - Porte vitrée • ES Cocina N. 4 planchas - Horno estático con asador cm. 64x42x35h, temp: 50÷250°C ,con 1 parilla cm.53x32,5 GN1/1 - Puerta vidrio
cm. 80x 65x 87h



⚡ 10,62 KW _____ **3.088,00**
400V~3N _____ 95 / 0,78
230V~3 _____
50/60 Hz _____

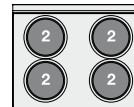

CF4-8ETS
07660833

CUCINA ELETTRICA CON N. 4 PIASTRE - FORNO ELETTRICO STATICO C/GRILL CM. 64X42X35H, TEMP: 50÷250°C, CON 1 GRIGLIA CM.53X32,5 GN1/1 - PORTA CIECA INOX
EN Range N. 4 plates - Static oven with grill cm. 64x42x35h, temp: 50÷250°C ,with 1 grid cm.53x32,5 GN1/1 - Stainless steel door • DE Elektroherd N. 4 Kochplatten Statischer Ofen mit Grill cm. 64x42x35h, temp: 50÷250°C ,with 1 grid cm.53x32,5 GN1/1 - Edelstahltür • FR Cuisinière N. 4 plaques - Four statique avec grill cm. 64x42x35h, temp: 50÷250°C ,mit 1 Rost cm.53x32,5 GN1/1 - Porte acier inoxydable • ES Cocina N. 4 planchas - Horno estático con asador cm. 64x42x35h, temp: 50÷250°C ,con 1 parilla cm.53x32,5 GN1/1 - Puerta ciega inox
cm. 80x 65x 87h



⚡ 10,62 KW _____ **3.088,00**
400V~3N _____ 95 / 0,78
230V~3 _____
50/60 Hz _____

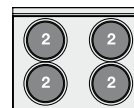

CF4-8G
07680850

CUCINA A GAS 4 FUOCHI FORNO A GAS STATICO CON GRILL CM. 64X39X35H, TEMP: 125÷275°C, CON 1 GRIGLIA CM.53X32,5 GN1/1 - PORTA VETRO
EN Gas range - N. 4 burners - Gas static oven with grill cm. 64x39x35h, temp: 125÷275°C, with 1 grid cm.53x32,5 GN1/1 - glass door • DE Gasherd - N. 4 Kochstellen - Gas Statischer Backofen mit grill cm. 64x39x35h, temp: 125÷275°C, mit 1 Rost cm.53x32,5 GN1/1 - Glastür • FR Cuisinière gaz - N. 4 feux vifs - Four gaz statique avec grill cm. 64x39x35h, temp: 125÷275°C, avec 1 grille cm.53x32,5 GN1/1 - Porte vitrée • ES Cocina gas - N. 4 quemadores - Horno gas estático con asador cm. 64x39x35h, temp: 125÷275°C, con 1 parilla cm.53x32,5 GN1/1 - Puerta vidrio
cm. 80x 65x 87h



⚡ 22 kW _____ **4.082,00**
18.920 kcal/h _____ 97 / 0,78
⚡ 0,03 kW _____
230V~ _____
50/60 Hz _____

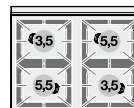

CF4-8G
07680851

CUCINA A GAS 4 FUOCHI FORNO A GAS STATICO CON GRILL CM. 64X39X35H, TEMP: 125÷275°C, CON 1 GRIGLIA CM.53X32,5 GN1/1 - PORTA CIECA INOX
EN Gas range - N. 4 burners - Gas static oven with grill cm. 64x39x35h, temp: 125÷275°C, with 1 grid cm.53x32,5 GN1/1 - Stainless steel door • DE Gasherd - N. 4 Kochstellen - Gas Statischer Backofen mit grill cm. 64x39x35h, temp: 125÷275°C, mit 1 Rost cm.53x32,5 GN1/1 - Edelstahltür/Porte acier inoxydable • FR Cuisinière gaz - N. 4 feux vifs - Four gaz statique avec grill cm. 64x39x35h, temp: 125÷275°C, avec 1 grille cm.53x32,5 GN1/1 - Porte acier inoxydable • ES Cocina gas - N. 4 quemadores - Horno gas estático con asador cm. 64x39x35h, temp: 125÷275°C, con 1 parilla cm.53x32,5 GN1/1 - Puerta ciega inox
cm. 80x 65x 87h



⚡ 22 kW _____ **4.082,00**
18.920 kcal/h _____ 97 / 0,78
⚡ 0,03 kW _____
230V~ _____
50/60 Hz _____

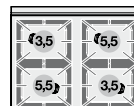

CF4-8GEM
07690860

CUCINA MISTA 4 FUOCHI CON FORNO ELETTRICO MULTIFUNZIONE - CAMERA CM. 64X37X35H, TEMP: 50÷250°C, CON 1 GRIGLIA CM.53X32,5 GN1/1 - PORTA VETRO
EN Combined range - N. 4 burners Multifunction oven - Chamber cm. 64x37x35h, temp: 50÷250°C ,with 1 grid cm.53x32,5 GN1/1 - Glass door • DE Gemischtherd - N. 4 Kochstellen Multifunktions-Ofen cm. 64x37x35h, temp: 50÷250°C ,with 1 grid cm.53x32,5 GN1/1 - Glastür • FR Cuisinière mixte - N. 4 feux vifs Four à fonctions multiples cm. 64x37x35h, temp: 50÷250°C ,avec 1 grille cm.53x32,5 GN1/1 - Porte vitrée • ES Cocina mixta - N. 4 quemadores Horno multifuncional - Cámara cm. 64x37x35h, temp: 50÷250°C ,con 1 parilla cm.53x32,5 GN1/1 - Puerta vidrio
cm. 80x 65x 87h



⚡ 18 kW _____ **4.098,00**
15.480 kcal/h _____ 96 / 0,78
⚡ 3,11 kW _____
230V~ _____
50/60 Hz _____

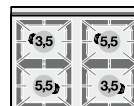

CUCINE A GAS CON FORNO ELETTRICO

MOD. _____
COD. _____

DESCRIZIONE/DESCRIPTION/BEZEICHNUNG/DESCRIPTION/DESCRIPCIÓN
DIMENSIONI/DIMENSIONS/ABMESSUNGEN/DIMENSIONS/DIMENSIONES

POTENZA/POWER/LEISTUNG/PUISSANCE/POTENCIA
VOLTAGGIO/VOLTAGE/SPANNUNG/VOLTAGE/VOLTAJE

⚡ 18 kW
15.480 kcal/h

PREZZO/PRICE
PREIS/PRIX/PRECIO
KG / M³



CF4-8GEM
07690861

**CUCINA MISTA 4 FUOCHI CON FORNO ELETTRICO
MULTIFUNZIONE - CAMERA CM. 64X37X35H, TEMP:
50÷250°C, CON 1 GRIGLIA CM.53X32,5 GN1/1 - PORTA
CIECA INOX**

EN Combined range - N. 4 burners Multifunction oven - Chamber cm. 64x37x35h, temp: 50÷250°C ,with 1 grid cm.53x32,5 GN1/1 - Stainless steel door • **DE** Gemischtherd - N. 4 Kochstellen Multifunktions-Ofen cm. 64x37x35h, temp: 50÷250°C ,with 1 grid cm.53x32,5 GN1/1 - Edelstahltür • **FR** Cuisinière mixte - N. 4 feux vifs Four à fonctions multiples cm. 64x37x35h, temp: 50÷250°C ,avec 1 grille cm.53x32,5 GN1/1 - Porte acier inoxydable • **ES** Cocina mixta - N. 4 quemadores Horno multifuncional - Cámara cm. 64x37x35h, temp: 50÷250°C ,con 1 parilla cm.53x32,5 GN1/1 - Puerta ciega inox
cm. 80x 65x 87h



⚡ 18 kW
15.480 kcal/h **4.098,00**
96 / 0,78

⚡ 3,11 kW
230V~
50/60 Hz

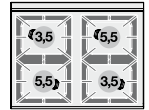

CF4-8GEMS
07690862

**CUCINA MISTA 4 FUOCHI CON FORNO ELETTRICO STATICO
C/GRILL CM. 64X42X35H, TEMP: 50÷250°C, CON 1 GRIGLIA
CM.53X32,5 GN1/1 - PORTA VETRO**

EN Combined range static oven - N. 4 burners Static oven with grill cm. 64x42x35h, temp: 50÷250°C ,with 1 grid cm.53x32,5 GN1/1 - Glass door • **DE** Gemischtherd statischer Ofen - N. 4 Kochstellen Statischer Ofen mit Grill cm. 64x42x35h, temp: 50÷250°C ,with 1 grid cm.53x32,5 GN1/1 - Glastür • **FR** Cuisinière mixte gaz four estático - N. 4 feux vifs Four statique avec grill cm. 64x42x35h, temp: 50÷250°C ,mit 1 Rost cm.53x32,5 GN1/1 - Porte vitrée • **ES** Cocina mixta horno estático - N. 4 quemadores Horno estático con asador cm. 64x42x35h, temp: 50÷250°C ,con 1 parilla cm.53x32,5 GN1/1 - Puerta vidrio
cm. 80x 65x 87h



⚡ 18 kW
15.480 kcal/h **3.851,00**
96 / 0,78

⚡ 2,62 kW
230V~
50/60 Hz

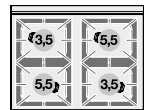

CF4-8GEMS
07690863

**CUCINA MISTA 4 FUOCHI CON FORNO ELETTRICO STATICO
C/GRILL CM. 64X42X35H, TEMP: 50÷250°C, CON 1 GRIGLIA
CM.53X32,5 GN1/1 - PORTA CIECA INOX**

EN Combined range static oven - N. 4 burners Static oven with grill cm. 64x42x35h, temp: 50÷250°C ,with 1 grid cm.53x32,5 GN1/1 - Stainless steel door • **DE** Gemischtherd statischer Ofen - N. 4 Kochstellen Statischer Ofen mit Grill cm. 64x42x35h, temp: 50÷250°C ,with 1 grid cm.53x32,5 GN1/1 - Edelstahltür • **FR** Cuisinière mixte gaz four estático - N. 4 feux vifs Four statique avec grill cm. 64x42x35h, temp: 50÷250°C ,mit 1 Rost cm.53x32,5 GN1/1 - Porte acier inoxydable • **ES** Cocina mixta horno estático - N. 4 quemadores Horno estático con asador cm. 64x42x35h, temp: 50÷250°C ,con 1 parilla cm.53x32,5 GN1/1 - Puerta ciega inox
cm. 80x 65x 87h



⚡ 18 kW
15.480 kcal/h **3.851,00**
96 / 0,78

⚡ 2,62 kW
230V~
50/60 Hz



CP-4ET
07100430

**CUOCIPASTA TRIFASE 17 LT. VASCA CM. 31X33,5X20H.
N. 2 CESTINI CM. 15X29X15H - ELETTROVALVOLA CARICO
ACQUA - RUBINETTO SCARICO + SFIORATORE.**

EN Pasta cooker threephase 17 lts. Tank cm. 31x33,5x20h. N. 2 baskets cm. 15x29x15h - Water loading electro-valve Drain-cock + overflow device • **DE** Nudelkocher dreiphasig 17 lt. Becken cm. 31x33,5x20h. Wasserlauf Elektroventil - Ablasshahn + Überlauf vorrichtung N. 2 Körbe cm. 15x29x15h • **FR** Cuiser à pates monophasé 17 lt. Cuve cm. 31x33,5x20h. N. 2 paniers cm. 15x29x15h - Soupape électrique d'arrivée d'eau Robinet de vidange + trop plein • **ES** Cuece pasta trifásico 17 lt. - Cuba cm 31x33,5x20h. N. 2 cestas cm. 15x29x15h Electroválvula carga agua - Grifo descarga + vertedero
cm. 40x 65x 29h



⚡ 4 kW
400V~2N **1.950,00**
27 / 0,18

230V~3
230V~
50/60 Hz

CP-6ET
07100630

**CUOCIPASTA TRIFASE 25 LT. VASCA CM. 51X30,5X20H.
N. 3 CESTINI CM. 15X29X15H - ELETTROVALVOLA CARICO
ACQUA - RUBINETTO SCARICO + SFIORATORE.**

EN Pasta cooker threephase 25 lts. Tank cm. 51x30,5x20h. N. 3 baskets cm. 15x29x15h - Water loading electro-valve Drain-cock + overflow device • **DE** Nudelkocher dreiphasig 25 lt. Becken cm. 51x30,5x20h. Wasserlauf Elektroventil - Ablasshahn + Überlauf vorrichtung N. 3 Körbe cm. 15x29x15h • **FR** Cuiser à pates monophasé 25 lt. Cuve cm. 51x30,5x20h. N. 3 paniers cm. 15x29x15h - Soupape électrique d'arrivée d'eau Robinet de vidange + trop plein • **ES** Cuece pasta trifásico 25 lt. - Cuba cm 51x30,5x20h. N. 3 cestas cm. 15x29x15h Electroválvula carga agua - Grifo descarga + vertedero
cm. 60x 65x 29h



⚡ 6 kW
400V~3N **2.717,00**
42 / 0,27

230V~3
50/60 Hz

CUOCIPASTA A GAS

MOD. _____
COD. _____

DESCRIZIONE/DESCRIPTION/BEZEICHNUNG/DESCRIPTION/DESCRIPCIÓN
DIMENSIONI/DIMENSIONS/ABMESSUNGEN/DIMENSIONS/DIMENSIONES

POTENZA/POWER/LEISTUNG/PUISSANCE/POTENCIA
VOLTAGGIO/VOLTAGE/SPANNUNG/VOLTAGE/VOLTAJE

$\frac{\text{kW}}{\text{kcal/h}}$ $\frac{\text{kW}}{\text{V-}}/\text{Hz}$

PREZZO/PRICE
PREIS/PRIX/PRECIO
KG / M³



CP-6G
07270650

CUOCIPASTA GAS - VASCA LT. 27 CM. 46X35X25H - N. 3 CESTI CM. 14,5X29X11H - RUBINETTO CARICO ACQUA + SFIORATORE

EN Gas pasta cooker - Tank capacity 27 lts. 46x35x25h N. 3 baskets cm. 14,5x29x11h Water loading cock + overflow device • **DE** Gas-Nudelkocher - Beckeninhalte lt. 27 cm. 46x35x25h N. 3 Körbe cm. 14,5x29x11h Wasserlauf Hahn + Überlaufvorrichtung • **FR** Cuiseur a pates gaz - Cuve lt. 27 46x35x25h - N. 3 paniers cm. 14,5x29x11h - Robinet d'arrivée d'eau + trop plein • **ES** Cuece pasta gas - Cuba 27 lt. cm. 46x35x25h - N. 3 cestas cm. 14,5x29x11h - Grifo carga agua + vertedero
cm. 60x 65x 29h



$\frac{14 \text{ kW}}{12.040 \text{ kcal/h}}$ **2.981,00**
47 / 0,27

CPM-6G
07270651

CUOCIPASTA GAS SU MOBILE - VASCA LT. 40 CM. 51X31X30H. N. 3 CESTI CM. 16X29X20H RUBINETTO CARICO ACQUA, SFIORATORE + SCARICO A PAVIMENTO

EN Gas pasta cooker on cabinet - Tank capacity 40 lts cm. 51x31x30h. N. 3 baskets cm. 16x29x20h Water loading, cock, overflow device and floor draining • **DE** Gas-Nudelkocher Standgerät - Inhalt lt. 40 cm. 51x31x30h. N. 3 Körbe cm. 16x29x20h Wasserlauf Hahn, Überlauf und Ablauf am Boden • **FR** Cuiseur a pates sur coffre gaz - Cuve lt. 40 cm. 51x31x30h - N. 3 paniers cm. 16x29x20h - Robinet d'arrivée d'eau, trop plein + système de vidange au sol • **ES** Cuece pasta gas en mueble - Cuba 40 lt. cm. 51x31x30h. N. 3 cestas cm. 16x29x20h - Grifo carga agua + vertedero + descarga a pavimento
cm. 60x 65x 87h



$\frac{13,5 \text{ kW}}{11.600 \text{ kcal/h}}$ **4.775,00**
84 / 0,59

CW-4ET
07080430

GRIGLIA ELETTRICA TRIFASE GRIGLIA IN ACCIAIO INOX CM. 38X47 REGOLABILE.

EN Electric grill threephase - Stainless steel adjustable grill cm. 38x47 • **DE** Elektro-Wurstbrater dreiphasig - Einstellbarer Rost aus Nirosta (cm. 38x47) • **FR** Grillade électrique triphase réglable - Grille inox cm 38x47 • **ES** Parrilla eléctrica trifásica - Parrilla de acero inox regulable 38x47 cm
cm. 40x 65x 29h



$\frac{6 \text{ kW}}{400\text{V}-3\text{N}}$ **1.897,00**
 $\frac{230\text{V}-3}{50/60 \text{ Hz}}$ 35.5 / 0,18

CW-6ET
07080630

GRIGLIA ELETTRICA TRIFASE N. 2 GRIGLIE IN ACCIAIO INOX CM. 28X47 REGOLABILI 2 ZONE DI COTTURA

EN Electric grill threephase - N. 2 adjustable stainless steel grills cm. 28x47 - 2 cooking areas • **DE** Elektro-Wurstbrater dreiphasig - Nr. 2 einstellbare Roste aus Nirosta (cm. 28x47) - 2 Heizzone • **FR** Grillade électrique triphase - N. 2 grilles inox réglable cm 28x47 - 2 zones de cuisson • **ES** Parrilla eléctrica trifásica - N. 2 parrillas de acero inox regulable 28x47 cm - 2 zonas de cocción
cm. 60x 65x 29h



$\frac{8 \text{ kW}}{400\text{V}-3\text{N}}$ **2.792,00**
 $\frac{230\text{V}-3}{50/60 \text{ Hz}}$ 48 / 0,27

CW-4G
07250450

GRIGLIA A GAS-PIETRALAVICA GRIGLIA IN ACCIAIO INOX CM. 38X47 REGOLABILE.

EN Charcoal grill gas - Stainless steel adjustable grill cm. 38x47 • **DE** Gas Lavasteingrill - Einstellbarer Rost aus Nirosta (cm. 38x47) • **FR** Grille a gaz en pierre de lave Grille réglable en acier inox cm. 38x47 • **ES** Parrilla a gas piedra lávica Parrilla de acero inox regulable 38x47 cm
cm. 40x 65x 29h



$\frac{6,5 \text{ kW}}{5.590 \text{ kcal/h}}$ **2.131,00**
41.5 / 0,18

CW-6G
07250650

GRIGLIA A GAS-PIETRALAVICA - N. 2 GRIGLIE IN ACCIAIO INOX CM. 28X47 REGOLABILI. 2 ZONE DI COTTURA

EN Charcoal grill gas - N. 2 Stainless steel adjustable grill cm. 28x47 - 2 cooking areas • **DE** Gas Lavasteingrill - Nr. 2 einstellbare Roste aus Nirosta (cm. 28x47) - 2 Heizzonen • **FR** Grille à gaz en pierre de lave - N. 2 grilles réglables en acier inox - cm. 28x47 - 2 zones de cuisson • **ES** Parrilla a gas piedra lávica - Parrilla de acero inox regulable 28x47 cm - 2 zonas de cocción
cm. 60x 65x 29h



$\frac{9,8 \text{ kW}}{8.420 \text{ kcal/h}}$ **3.155,00**
58.5 / 0,27

FRIGGITRICI ELETTRICHE

MOD. _____
COD. _____

DESCRIZIONE/DESCRIPTION/BEZEICHNUNG/DESCRIPTION/DESCRIPCIÓN
DIMENSIONI/DIMENSIONS/ABMESSUNGEN/DIMENSIONS/DIMENSIONES

POTENZA/POWER/LEISTUNG/PUISSANCE/POTENCIA
VOLTAGGIO/VOLTAGE/SPANNUNG/VOLTAGE/VOLTAJE

⚡ kcal/h ⚡ kW
V~ V~
Hz Hz

PREZZO/PRICE
PREIS/PRIX/PRECIO
KG / M³



FQ-4EM
07090410

FRIGGITRICE VASCA LT. 10 CM. 22X35X22H - CESTO CM. 20X30X10H PRODUZIONE PATATE 8 KG/H
EN Fryer - Tank capacity 10 lts. cm. 22x35x22h Basket cm. 20x30x10h - Production 8 kg/hr • **DE** Friteuse - Becken lt. 10 cm. 22x35x22h Körb cm. 20x30x10h - Pommes frites 8 kg/pro Stunde • **FR** Friteuse - Cuve 10 lt. cm. 22x35x22h - Panier cm 20x30x10h - Production de pommes frites 8 kg/h • **ES** Freidora - Cuba 10 lt. - cm. 22x35x22h Cesta cm. 20x30x10h - Producción patatas 8 Kg/h
cm. 40x 65x 29h



⚡ 3,65 kW **1.312,00**
230V~ 25.5 / 0,18
50/60 Hz

FQ-4ET
07090430

FRIGGITRICE TRIFASE VASCA LT. 10 CM. 22X35X22H - CESTO CM. 20X30X10H PRODUZIONE PATATE 10 KG/H
EN Fryer threephase - Tank capacity 10 lts. cm. 22x35x22h Basket cm. 20x30x10h - Production 10 kg/hr • **DE** Friteuse dreiphasig - Becken lt. 10 cm. 22x35x22h Körb cm. 20x30x10h - Pommes frites 10 kg/pro Stunde • **FR** Friteuse triphase - Cuve 10 lt. cm. 22x35x22h - Panier cm 20x30x10h - Production de pommes frites 10 Kg/h • **ES** Freidora trifásica - Cuba 10 lt. - cm. 22x35x22h Cesta cm. 20x30x10h - Producción patatas 10 Kg/h
cm. 40x 65x 29h

⚡ 7,15 kW **1.497,00**
400V~3N 26.5 / 0,18
230V~3
50/60 Hz

FQ-6EM
07090610

FRIGGITRICE 2 VASCHE LT. 10 CM. 22X35X22H - 2 CESTI CM. 20X30X10H PRODUZIONE PATATE 16 KG/H
EN Fryer - 2 Tanks capacity 10 lts. cm. 22x35x22h - 2 Baskets cm. 20x30x10h - Production 16 kg/hr • **DE** Friteuse - 2 Becken lt. 10 cm. 22x35x22h - 2 Körbe cm. 20x30x10h - Pommes frites 16 kg/pro Stunde • **FR** Friteuse - 2 Cuves 10 l. cm. 22x35x22h - 2 Paniers cm 20x30x10h - Production de pommes frites 16 kg/h • **ES** Freidora - 2 Cubas 10 l. cm. 22x35x22h - 2 Cestas cm 20x30x10h - Producción patatas 16 Kg/h
cm. 60x 65x 29h



⚡ 7,2 kW **2.635,00**
230V~ 39.5 / 0,27
50/60 Hz

FQ-6ET
07090630

FRIGGITRICE TRIFASE 2 VASCHE LT. 10 CM. 22X35X22H - 2 CESTI CM. 20X30X10H PRODUZIONE PATATE 20 KG/H
EN Fryer threephase - 2 Tanks capacity 10 lts. cm. 22x35x22h - 2 Baskets cm. 20x30x10h - Production 20 kg/hr • **DE** Friteuse dreiphasig - 2 Becken lt. 10 cm. 22x35x22h - 2 Körbe cm. 20x30x10h - Pommes frites 20 kg/pro Stunde • **FR** Friteuse triphase - 2 Cuves 10 l. cm. 22x35x22h - 2 Paniers cm 20x30x10h - Production de pommes frites 20 Kg/h • **ES** Freidora trifásica - 2 Cubas 10 l. cm. 22x35x22h - 2 Cestas cm 20x30x10h - Producción patatas 20 Kg/h
cm. 60x 65x 29h

⚡ 14,3 kW **2.779,00**
400V~3N 41.5 / 0,27
230V~3
50/60 Hz

FP-6ET
07091630

FRIGGITRICE VASCA LT. 23 CM. 50X35X22H - CESTO CM. 46X30X10H
EN Fryer - Tank capacity 23 lts. cm. 50x35x22h Basket cm. 46x30x10h • **DE** Friteuse - Becken lt. 23 cm. 50x35x22h Körb cm. 46x30x10h • **FR** Friteuse - Cuve 23 l. cm. 50x35x22h Panier cm 46x30x10h • **ES** Freidora - Cuba 23 l. cm. 50x35x22h Cesta cm. 46x30x10h
cm. 60x 65x 29h

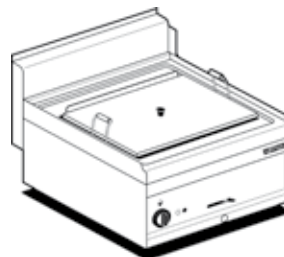

⚡ 14,3 kW **2.314,00**
400V~3N 40 / 0,27
50/60 Hz

FQ-4G
07260450

FRIGGITRICE GAS - VASCA LT. 10 CM. 22X35X25H CESTO CM. 20X30X10H - PRODUZIONE PATATE: 10 KG/H
EN Gas fryer - Tank capacity 10 lts. cm. 22x35x25h Basket cm. 20x30x10h - Production: 10 kg/h • **DE** Gas-Einzelfriteuse - Beckeninhalt lt. 10 cm. 22x35x25h Korb cm. 20x30x10h - Pommes frites: 10 kg/pro Stunde • **FR** Friteuse gaz - Cuve lt. 10. cm. 22x35x25h Panier cm. 20x30x10h - Production de pommes frites: 10 kg/h • **ES** Freidoras gas - Cuba 10 l. cm. 22x35x25h Cesta cm. 20x30x10h - Producción patatas: 10 Kg/h
cm. 40x 65x 29h



⚡ 7 kW **2.024,00**
6.020 kcal/h 30 / 0,18

FRIGGITRICI A GAS

MOD. _____
COD. _____

DESCRIZIONE/DESCRIPTION/BEZEICHNUNG/DESCRIPTION/DESCRIPCIÓN
DIMENSIONI/DIMENSIONS/ABMESSUNGEN/DIMENSIONS/DIMENSIONES

POTENZA/POWER/LEISTUNG/PUISSANCE/POTENCIA
VOLTAGGIO/VOLTAGE/SPANNUNG/VOLTAGE/VOLTAJE

⚡ $\frac{\text{kW}}{\text{kcal/h}}$ $\frac{\text{kW}}{\text{V} \sim}$
Hz

PREZZO/PRICE
PREIS/PRIX/PRECIO
KG / M³



FQ-6G
07260650

FRIGGITRICE GAS - 2 VASCHE LT. 10 CM.22X35X25H 2 CESTI CM. 20X30X10H - PRODUZIONE PATATE: 20 KG/H

EN Gas fryer - 2 tanks capacity 10 lts. cm.22x35x25h 2 baskets cm. 20x30x10h - Production: 20 kg/h • **DE** Gas-Doppelfriteuse - lt. 10 + 10 Becken cm. 22x35x25h - 2 Korbe cm.20x30x10h Pommes frites: 20 kg/pro Stunde • **FR** Friteuse gaz - 2 Cuves 10 lt. cm.22x35x25h 2 Paniers cm. 20x30x10h Production de pommes frites: 20 kg/h • **ES** Freidoras gas - 2 Cuba 10 l. cm22x35x25h 2 cestas cm. 20x30x10h - Producción patatas: 20 Kg/h
cm. 60x 65x 29h



⚡ $\frac{14 \text{ kW}}{12.040 \text{ kcal/h}}$ **3.192,00**
48.5 / 0,27

FP-6G
07260652

FRIGGITRICE GAS - VASCA LT. 20 CM.46X35X25H CESTO CM. 42,5X31X10H

EN Gas fryer - Tank capacity 20 lts. cm. 46x35x25h Basket cm. 42,5x31x10h • **DE** Gas-Einzelfriteuse - Beckeninhalt lt. 20 cm. 46x35x25h Korb cm. 42,5x31x10h • **FR** Friteuse gaz - Cuve lt. 20 cm. 46x35x25h Panier cm. 42,5x31x10h • **ES** Freidoras gas - Cuba 20 lt. 46x35x25h cm. Cesta cm. 42,5x31x10h
cm. 60x 65x 29h



⚡ $\frac{14 \text{ kW}}{12.040 \text{ kcal/h}}$ **2.659,00**
44.5 / 0,27

FQM-4G
07260451

FRIGGITRICE GAS SU MOBILE - VASCA LT. 15 CM. 33X38X38H - CESTO CM. 30X33X12H - BACINELLA RACCOGLI OLIO CON FILTRO - PRODUZIONE PATATE: 15 KG/H

EN Gas fryer on cabinet - Tank capacity 15 lts. cm. 33x38x38h - Basket cm. 30x33x12h Production: 15 kg/h - Drip tray with sieve • **DE** Gas-Standfriteuse - Beckeninhalt lt. 15 cm.33x38x38h Korb cm. 30x33x12h - Fettauffangschale mit Sieb, Pommes frites: 15 kg/pro Stunde • **FR** Friteuse gaz sur placard - Cuve lt 15 cm.33x38x38h Panier cm. 30x33x12h - Production de pommes frites: 15 kg/h - Bac de récupération de l'huile et filtre • **ES** Freidora gas en mueble - Cuba 15 l. cm33x38x38h Cesta cm. 30x33x12h - Bandeja recoge aceite con filtro Producción patatas: 15 Kg/h
cm. 40x 65x 87h



⚡ $\frac{13,5 \text{ kW}}{11.650 \text{ kcal/h}}$ **2.767,00**
60 / 0,40

FTL-4EM
07060411

FRY-TOP ELETTRICO LISCIO, PIASTRA CM.35,5X55

EN Electric Fry-top smooth griddle, plate cm.35,5x55 • **DE** Griddleplatte elektrische glatt, platte cm.35,5x55 • **FR** Plaque électriques lisse, plaque cm.35,5x55 • **ES** Fry-top eléctrico liso, plancha cm.35,5x55
cm. 40x 65x 29h



⚡ $\frac{3 \text{ kW}}{230V \sim}$ **1.248,00**
50/60 Hz 49 / 0,18

FTL-4ET
07060431

cm. 40x 65x 29h

⚡ $\frac{4,5 \text{ kW}}{400V \sim 3N}$ **1.338,00**
230V~3 49 / 0,18
50/60 Hz

FTL-4EMS
07060414

FRY-TOP ELETTRICO LISCIO CROMATO SUPERCHROME (MOCA APPROVED), PIASTRA CM.35,5X55

EN Electric Fry-top smooth chromed griddle SUPERCHROME (Moca Approved), plate cm.35,5x55 • **DE** Griddleplatte elektrische glatt hartverchromt SUPERCHROME (Moca Approved), platte cm.35,5x55 • **FR** Plaque électriques lisse chromée SUPERCHROME (Moca Approved), plaque cm.35,5x55 • **ES** Fry-top eléctrico liso cromado SUPERCHROME (Moca Approved), plancha cm.35,5x55
cm. 40x 65x 29h



⚡ $\frac{3 \text{ kW}}{230V \sim}$ **1.592,00**
50/60 Hz 49 / 0,18

FTL-4ETS
07060434

cm. 40x 65x 29h

⚡ $\frac{4,5 \text{ kW}}{400V \sim 3N}$ **1.719,00**
230V~3 49 / 0,18
50/60 Hz

FRY-TOP ELETTRICI

MOD. _____
COD. _____

DESCRIZIONE/DESCRIPTION/BEZEICHNUNG/DESCRIPTION/DESCRIPCIÓN
DIMENSIONI/DIMENSIONS/ABMESSUNGEN/DIMENSIONS/DIMENSIONES

POTENZA/POWER/LEISTUNG/PUISSANCE/POTENCIA
VOLTAGGIO/VOLTAGE/SPANNUNG/VOLTAGE/VOLTAJE

⚡ kW _____
230V~
kcal/h _____
V~
Hz _____

PREZZO/PRICE
PREIS/PRIX/PRECIO
KG / M³



FTR-4EM
07060413

FRY-TOP ELETTRICO RIGATO, PIASTRA CM.35,5X55
EN Electric Fry-top grooved griddle, plate cm.35,5x55 • **DE** Griddleplatte elektrische gerillt, platte cm.35,5x55 • **FR** Plaque électriques nervurée, plaque cm.35,5x55 • **ES** Fry-top eléctrico estriado, plancha cm.35,5x55
cm. 40x 65x 29h



⚡ 3 kW _____ **1.450,00**
230V~ _____ 49 / 0,18
50/60 Hz _____



FTR-4ET
07060433

cm. 40x 65x 29h

⚡ 4,5 kW _____ **1.510,00**
400V~3N _____ 49 / 0,18
230V~3 _____
50/60 Hz _____

FTR-4EMS
07060416

FRY-TOP ELETTRICO RIGATO CROMATO SUPERCHROME (MOCA APPROVED, PIASTRA CM.35,5X55)
EN Electric Fry-top grooved chromed griddle SUPERCHROME (Moca Approved), plate cm.35,5x55 • **DE** Griddleplatte elektrische gerillt hartverchromt SUPERCHROME (Moca Approved), platte cm.35,5x55 • **FR** Plaque électriques nervurée chromée SUPERCHROME (Moca Approved), plaque cm.35,5x55 • **ES** Fry-top eléctrico estriado cromado SUPERCHROME (Moca Approved), plancha cm.35,5x55
cm. 40x 65x 29h

⚡ 3 kW _____ **1.765,00**
230V~ _____ 49 / 0,18
50/60 Hz _____



FTR-4ETS
07060436

cm. 40x 65x 29h

⚡ 4,5 kW _____ **1.888,00**
400V~3N _____ 49 / 0,18
230V~3 _____
50/60 Hz _____

FTL-6ET
07060631

FRY-TOP ELETTRICO LISCIO, PIASTRA CM.55,5X55 - 2 ZONE DI COTTURA
EN Electric Fry-top smooth griddle, plate cm.55,5x55 - 2 cooking areas
• **DE** Griddleplatte elektrische glatt, platte cm.55,5x55 - 2 Heizzonen
• **FR** Plaque électriques lisse, plaque cm.55,5x55 - 2 zones de cuisson
• **ES** Fry-top eléctrico liso, plancha cm.55,5x55 - 2 zonas de cocción
cm. 60x 65x 29h

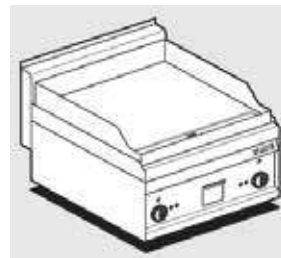

⚡ 6 kW _____ **1.826,00**
400V~3N _____ 66.5 / 0,27
230V~3 _____
230V~ _____
50/60 Hz _____



FTL-6ETS
07060634

FRY-TOP ELETTRICO LISCIO CROMATO SUPERCHROME (MOCA APPROVED, PIASTRA CM.55,5X55 - 2 ZONE DI COTTURA)
EN Electric Fry-top smooth chromed griddle SUPERCHROME (Moca Approved), plate cm.55,5x55 - 2 cooking areas • **DE** Griddleplatte elektrische glatt hartverchromt SUPERCHROME (Moca Approved), platte cm.55,5x55 - 2 Heizzonen • **FR** Plaque électriques lisse chromée SUPERCHROME (Moca Approved), plaque cm.55,5x55 - 2 zones de cuisson • **ES** Fry-top eléctrico liso cromado SUPERCHROME (Moca Approved), plancha cm.55,5x55 - 2 zonas de cocción
cm. 60x 65x 29h

⚡ 6 kW _____ **2.480,00**
400V~3N _____ 66.5 / 0,27
230V~3 _____
230V~ _____
50/60 Hz _____



FTLR-6ET
07060632

FRY-TOP ELETTRICO 1/2 RIGATO + 1/2 LISCIO, PIASTRA CM.55,5X55 - 2 ZONE DI COTTURA
EN Electric Fry-top 1/2 grooved + 1/2 smooth, plate cm.55,5x55 - 2 cooking areas • **DE** Griddleplatte elektrische 1/2 gerillt + 1/2 glatt, platte cm.55,5x55 - 2 Heizzonen • **FR** Plaque électriques 1/2 nervurée + 1/2 lisse, plaque cm.55,5x55 - 2 zones de cuisson • **ES** Fry-top eléctrico 1/2 estriado + 1/2 liso, plancha cm.55,5x55 - 2 zonas de cocción
cm. 60x 65x 29h

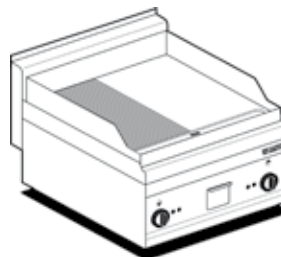

⚡ 6 kW _____ **1.999,00**
400V~3N _____ 66.5 / 0,27
230V~3 _____
230V~ _____
50/60 Hz _____



FRY-TOP ELETTRICI

MOD. _____
COD. _____

DESCRIZIONE/DESCRIPTION/BEZEICHNUNG/DESCRIPTION/DESCRIPCIÓN
DIMENSIONI/DIMENSIONS/ABMESSUNGEN/DIMENSIONS/DIMENSIONES

POTENZA/POWER/LEISTUNG/PUISSANCE/POTENCIA
VOLTAGGIO/VOLTAGE/SPANNUNG/VOLTAGE/VOLTAJE

⚡ kW
kcal/h

⚡ kw
V~
Hz

PREZZO/PRICE
PREIS/PRIX/PRECIO
KG / M³



FTLR-6ETS
07060635

FRY-TOP ELETTRICO 1/2 RIGATO + 1/2 LISCIO CROMATO SUPERCHROME (MOCA APPROVED, PIASTRA CM.55,5X55 - 2 ZONE DI COTTURA

EN Electric Fry-top 1/2 grooved + 1/2 smooth chromed griddle SUPERCHROME (Moca Approved), plate cm.55,5x55 - 2 cooking areas
 • **DE** Griddleplatte elektrische 1/2 gerillt + 1/2 glatt hartverchromt SUPERCHROME (Moca Approved), platte cm.55,5x55 - 2 Heizzonen
 • **FR** Plaque électriques 1/2 nervurée + 1/2 lisse chromée SUPERCHROME (Moca Approved), plaque cm.55,5x55 - 2 zones de cuisson
 • **ES** Fry-top eléctrico 1/2 estriado + 1/2 liso cromado SUPERCHROME (Moca Approved), plancha cm.55,5x55 - 2 zonas de cocción
cm. 60x 65x 29h

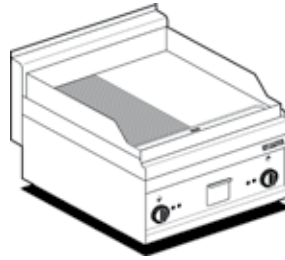

⚡ 6 kW
400V~3N
230V~3
230V~
50/60 Hz

2.653,00
66.5 / 0,27



FTR-6ET
07060633

FRY-TOP ELETTRICO RIGATO, PIASTRA CM.55,5X55 - 2 ZONE DI COTTURA

EN Electric Fry-top grooved griddle, plate cm.55,5x55 - 2 cooking areas
 • **DE** Griddleplatte elektrische gerillt, platte cm.55,5x55 - 2 Heizzonen
 • **FR** Plaque électriques nervurée, plaque cm.55,5x55 - 2 zones de cuisson
 • **ES** Fry-top eléctrico estriado, plancha cm.55,5x55 - 2 zonas de cocción
cm. 60x 65x 29h



⚡ 6 kW
400V~3N
230V~3
230V~
50/60 Hz

2.169,00
66.5 / 0,27



FTR-6ETS
07060636

FRY-TOP ELETTRICO RIGATO CROMATO SUPERCHROME (MOCA APPROVED, PIASTRA CM.55,5X55 - 2 ZONE DI COTTURA

EN Electric Fry-top grooved chromed griddle SUPERCHROME (Moca Approved), plate cm.55,5x55 - 2 cooking areas
 • **DE** Griddleplatte elektrische gerillt hartverchromt SUPERCHROME (Moca Approved), platte cm.55,5x55 - 2 Heizzonen
 • **FR** Plaque électriques nervurée chromée SUPERCHROME (Moca Approved), plaque cm.55,5x55 - 2 zones de cuisson
 • **ES** Fry-top eléctrico estriado cromado SUPERCHROME (Moca Approved), plancha cm.55,5x55 - 2 zonas de cocción
cm. 60x 65x 29h



⚡ 6 kW
400V~3N
230V~3
230V~
50/60 Hz

2.826,00
66.5 / 0,27



FTLR-8ET
07060831

FRY-TOP ELETTRICO LISCIO, PIASTRA CM.75,5X55 - 2 ZONE DI COTTURA

EN Electric Fry-top smooth griddle, plate cm.75,5x55 - 2 cooking areas
 • **DE** Griddleplatte elektrische glatt, platte cm.75,5x55 - 2 Heizzonen
 • **FR** Plaque électriques lisse, plaque cm.75,5x55 - 2 zones de cuisson
 • **ES** Fry-top eléctrico liso, plancha cm.75,5x55 - 2 zonas de cocción
cm. 80x 65x 29h



⚡ 9 kW
400V~3N
230V~3
50/60 Hz

2.526,00
82 / 0,35



FTLR-8ETS
07060834

FRY-TOP ELETTRICO LISCIO CROMATO SUPERCHROME (MOCA APPROVED, PIASTRA CM.75,5X55 - 2 ZONE DI COTTURA

EN Electric Fry-top smooth chromed griddle SUPERCHROME (Moca Approved), plate cm.75,5x55 - 2 cooking areas
 • **DE** Griddleplatte elektrische glatt hartverchromt SUPERCHROME (Moca Approved), platte cm.75,5x55 - 2 Heizzonen
 • **FR** Plaque électriques lisse chromée SUPERCHROME (Moca Approved), plaque cm.75,5x55 - 2 zones de cuisson
 • **ES** Fry-top eléctrico liso cromado SUPERCHROME (Moca Approved), plancha cm.75,5x55 - 2 zonas de cocción
cm. 80x 65x 29h



⚡ 9 kW
400V~3N
230V~3
50/60 Hz

3.305,00
82 / 0,35



FTLR-8ET
07060832

FRY-TOP ELETTRICO 1/2 RIGATO + 1/2 LISCIO, PIASTRA CM.75,5X55 - 2 ZONE DI COTTURA

EN Electric Fry-top 1/2 grooved + 1/2 smooth, plate cm.75,5x55 - 2 cooking areas
 • **DE** Griddleplatte elektrische 1/2 gerillt + 1/2 glatt, platte cm.75,5x55 - 2 Heizzonen
 • **FR** Plaque électriques 1/2 nervurée + 1/2 lisse, plaque cm.75,5x55 - 2 zones de cuisson
 • **ES** Fry-top eléctrico 1/2 estriado + 1/2 liso, plancha cm.75,5x55 - 2 zonas de cocción
cm. 80x 65x 29h



⚡ 9 kW
400V~3N
230V~3
50/60 Hz

2.711,00
82 / 0,35



FRY-TOP ELETTRICI

MOD. _____
COD. _____

DESCRIZIONE/DESCRIPTION/BEZEICHNUNG/DESCRIPTION/DESCRIPCIÓN
DIMENSIONI/DIMENSIONS/ABMESSUNGEN/DIMENSIONS/DIMENSIONES

POTENZA/POWER/LEISTUNG/PUISSANCE/POTENCIA
VOLTAGGIO/VOLTAGE/SPANNUNG/VOLTAGE/VOLTAJE

⚡ $\frac{\text{kW}}{\text{kcal/h}}$ $\frac{\text{kW}}{\text{V-}} \frac{\text{Hz}}$

PREZZO/PRICE
PREIS/PRIX/PRECIO
KG / M³



FTLR-8ETS
07060835

FRY-TOP ELETTRICO 1/2 RIGATO + 1/2 LISCIO CROMATO SUPERCHROME (MOCA APPROVED, PIASTRA CM.75,5X55 - 2 ZONE DI COTTURA

EN Electric Fry-top 1/2 grooved + 1/2 smooth chromed griddle SUPERCHROME (Moca Approved), plate cm.75,5x55 - 2 cooking areas
 • **DE** Griddleplatte elektrische 1/2 gerillt + 1/2 glatt hartverchromt SUPERCHROME (Moca Approved), platte cm.75,5x55 - 2 Heizzonen
 • **FR** Plaque électriques 1/2 nervurée + 1/2 lisse chromée SUPERCHROME (Moca Approved), plaque cm.75,5x55 - 2 zones de cuisson • **ES** Fry-top eléctrico 1/2 estriado + 1/2 liso cromado SUPERCHROME (Moca Approved), plancha cm.75,5x55 - 2 zonas de cocción
cm. 80x 65x 29h



⚡ $\frac{9 \text{ kW}}{400\text{V}\sim 3\text{N}}$ **3.506,00**
 $\frac{82}{230\text{V}\sim 3}$ / 0,35
 $\frac{50/60 \text{ Hz}}$



FTL-4G
07230451

FRY-TOP GAS LISCIO, PIASTRA CM.35,5X55

EN Gas Fry-top smooth griddle, plate cm.35,5x55 • **DE** Gas-griddleplatte glatt, platte cm.35,5x55 • **FR** Plaque gaz lisse, plaque cm.35,5x55 • **ES** Fry-top gas liso, plancha cm.35,5x55
cm. 40x 65x 29h



⚡ $\frac{7 \text{ kW}}{6.020 \text{ kcal/h}}$ **1.551,00**
 $\frac{46}{0,18}$



FTL-4GS
07230454

FRY-TOP GAS LISCIO CROMATO SUPERCHROME (MOCA APPROVED, PIASTRA CM.35,5X55

EN Gas Fry-top smooth chromed griddle SUPERCHROME (Moca Approved), plate cm.35,5x55 • **DE** Gas-griddleplatte glatt hartverchromt SUPERCHROME (Moca Approved), platte cm.35,5x55 • **FR** Plaque gaz lisse chromée SUPERCHROME (Moca Approved), plaque cm.35,5x55
 • **ES** Fry-top gas liso cromado SUPERCHROME (Moca Approved), plancha cm.35,5x55
cm. 40x 65x 29h



⚡ $\frac{7 \text{ kW}}{6.020 \text{ kcal/h}}$ **2.113,00**
 $\frac{46}{0,18}$



FTL-4G
07230453

FRY-TOP GAS RIGATO, PIASTRA CM.35,5X55

EN Gas Fry-top grooved griddle, plate cm.35,5x55 • **DE** Gas-griddleplatte gerillt, platte cm.35,5x55 • **FR** Plaque gaz nervurée, plaque cm.35,5x55 • **ES** Fry-top gas estriado, plancha cm.35,5x55
cm. 40x 65x 29h



⚡ $\frac{7 \text{ kW}}{6.020 \text{ kcal/h}}$ **1.748,00**
 $\frac{46}{0,18}$



FTL-4GS
07230456

FRY-TOP GAS RIGATO CROMATO SUPERCHROME (MOCA APPROVED, PIASTRA CM.35,5X55

EN Gas Fry-top grooved chromed griddle SUPERCHROME (Moca Approved), plate cm.35,5x55 • **DE** Gas-griddleplatte gerillt hartverchromt SUPERCHROME (Moca Approved), platte cm.35,5x55
 • **FR** Plaque gaz nervurée chromée SUPERCHROME (Moca Approved), plaque cm.35,5x55 • **ES** Fry-top gas estriado cromado SUPERCHROME (Moca Approved), plancha cm.35,5x55
cm. 40x 65x 29h

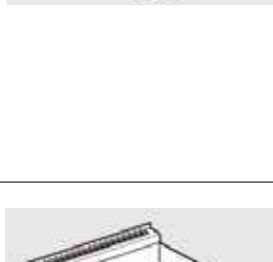

⚡ $\frac{7 \text{ kW}}{6.020 \text{ kcal/h}}$ **2.296,00**
 $\frac{46}{0,18}$



FTL-6G
07230651

FRY-TOP GAS LISCIO, PIASTRA CM.55,5X55 - 2 ZONE DI COTTURA

EN Gas Fry-top smooth griddle, plate cm.55,5x55 - 2 cooking areas
 • **DE** Gas-griddleplatte glatt, platte cm.55,5x55 - 2 Heizzonen • **FR** Plaque gaz lisse, plaque cm.55,5x55 - 2 zones de cuisson • **ES** Fry-top gas liso, plancha cm.55,5x55 - 2 zonas de cocción
cm. 60x 65x 29h

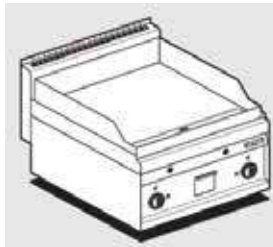

⚡ $\frac{10,5 \text{ kW}}{9.030 \text{ kcal/h}}$ **2.062,00**
 $\frac{65,5}{0,27}$



FTL-6GS
07230654

FRY-TOP GAS LISCIO CROMATO SUPERCHROME (MOCA APPROVED, PIASTRA CM.55,5X55 - 2 ZONE DI COTTURA

EN Gas Fry-top smooth chromed griddle SUPERCHROME (Moca Approved), plate cm.55,5x55 - 2 cooking areas • **DE** Gas-griddleplatte glatt hartverchromt SUPERCHROME (Moca Approved), platte cm.55,5x55 - 2 Heizzonen • **FR** Plaque gaz lisse chromée SUPERCHROME (Moca Approved), plaque cm.55,5x55 - 2 zones de cuisson • **ES** Fry-top gas liso cromado SUPERCHROME (Moca Approved), plancha cm.55,5x55 - 2 zonas de cocción
cm. 60x 65x 29h



⚡ $\frac{10,5 \text{ kW}}{9.030 \text{ kcal/h}}$ **2.699,00**
 $\frac{65,5}{0,27}$



FRY-TOP A GAS

MOD. _____
COD. _____

DESCRIZIONE/DESCRIPTION/BEZEICHNUNG/DESCRIPTION/DESCRIPCIÓN
DIMENSIONI/DIMENSIONS/ABMESSUNGEN/DIMENSIONS/DIMENSIONES

POTENZA/POWER/LEISTUNG/PUISSANCE/POTENCIA
VOLTAGGIO/VOLTAGE/SPANNUNG/VOLTAGE/VOLTAJE

$\frac{kW}{kcal/h}$ $\frac{V}{Hz}$

PREZZO/PRICE
PREIS/PRIX/PRECIO
KG / M³



FTLR-6G
07230652

FRY-TOP GAS 1/2 RIGATO + 1/2 LISCIO, PIASTRA CM.55,5X55 - 2 ZONE DI COTTURA

EN Gas Fry-top 1/2 grooved + 1/2 smooth, plate cm.55,5x55 - 2 cooking areas • **DE** Gas-griddleplatte 1/2 gerillt + 1/2 glatt, platte cm.55,5x55 - 2 Heizzonen • **FR** Plaque gaz 1/2 nervurée + 1/2 lisse, plaque cm.55,5x55 - 2 zones de cuisson • **ES** Fry-top gas 1/2 estriado + 1/2 liso, plancha cm.55,5x55 - 2 zonas de cocción
cm. 60x 65x 29h



$\frac{10,5 kW}{9.030 kcal/h}$ **2.232,00**
65.5 / 0,27



FTLR-6GS
07230655

FRY-TOP GAS 1/2 RIGATO + 1/2 LISCIO CROMATO SUPERCHROME (MOCA APPROVED), PIASTRA CM.55,5X55 - 2 ZONE DI COTTURA

EN Gas Fry-top 1/2 grooved + 1/2 smooth chromed griddle SUPERCHROME (Moca Approved), plate cm.55,5x55 - 2 cooking areas • **DE** Gas-griddleplatte 1/2 gerillt + 1/2 glatt hartverchromt SUPERCHROME (Moca Approved), platte cm.55,5x55 - 2 Heizzonen • **FR** Plaque gaz 1/2 nervurée + 1/2 lisse chromée SUPERCHROME (Moca Approved), plaque cm.55,5x55 - 2 zones de cuisson • **ES** Fry-top gas 1/2 estriado + 1/2 liso cromado SUPERCHROME (Moca Approved), plancha cm.55,5x55 - 2 zonas de cocción
cm. 60x 65x 29h

$\frac{10,5 kW}{9.030 kcal/h}$ **2.880,00**
65.5 / 0,27



FTR-6G
07230653

FRY-TOP GAS RIGATO, PIASTRA CM.55,5X55 - 2 ZONE DI COTTURA

EN Gas Fry-top grooved griddle, plate cm.55,5x55 - 2 cooking areas • **DE** Gas-griddleplatte gerillt, platte cm.55,5x55 - 2 Heizzonen • **FR** Plaque gaz nervurée, plaque cm.55,5x55 - 2 zones de cuisson • **ES** Fry-top gas estriado, plancha cm.55,5x55 - 2 zonas de cocción
cm. 60x 65x 29h



$\frac{10,5 kW}{9.030 kcal/h}$ **2.416,00**
65.5 / 0,27



FTR-6GS
07230656

FRY-TOP GAS RIGATO CROMATO SUPERCHROME (MOCA APPROVED), PIASTRA CM.55,5X55 - 2 ZONE DI COTTURA

EN Gas Fry-top grooved chromed griddle SUPERCHROME (Moca Approved), plate cm.55,5x55 - 2 cooking areas • **DE** Gas-griddleplatte gerillt hartverchromt SUPERCHROME (Moca Approved), platte cm.55,5x55 - 2 Heizzonen • **FR** Plaque gaz nervurée chromée SUPERCHROME (Moca Approved), plaque cm.55,5x55 - 2 zones de cuisson • **ES** Fry-top gas estriado cromado SUPERCHROME (Moca Approved), plancha cm.55,5x55 - 2 zonas de cocción
cm. 60x 65x 29h

$\frac{10,5 kW}{9.030 kcal/h}$ **3.059,00**
65.5 / 0,27



FTL-8G
07230851

FRY-TOP GAS LISCIO, PIASTRA CM.75,5X55 - 2 ZONE DI COTTURA

EN Gas Fry-top smooth griddle, plate cm.75,5x55 - 2 cooking areas • **DE** Gas-griddleplatte glatt, platte cm.75,5x55 - 2 Heizzonen • **FR** Plaque gaz lisse, plaque cm.75,5x55 - 2 zones de cuisson • **ES** Fry-top gas liso, plancha cm.75,5x55 - 2 zonas de cocción
cm. 80x 65x 29h



$\frac{14 kW}{12.040 kcal/h}$ **3.227,00**
84 / 0,35

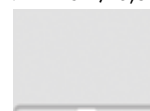

FTL-8GS
07230854

FRY-TOP GAS LISCIO CROMATO SUPERCHROME (MOCA APPROVED), PIASTRA CM.75,5X55 - 2 ZONE DI COTTURA

EN Gas Fry-top smooth chromed griddle SUPERCHROME (Moca Approved), plate cm.75,5x55 - 2 cooking areas • **DE** Gas-griddleplatte glatt hartverchromt SUPERCHROME (Moca Approved), platte cm.75,5x55 - 2 Heizzonen • **FR** Plaque gaz lisse chromée SUPERCHROME (Moca Approved), plaque cm.75,5x55 - 2 zones de cuisson • **ES** Fry-top gas liso cromado SUPERCHROME (Moca Approved), plancha cm.75,5x55 - 2 zonas de cocción
cm. 80x 65x 29h

$\frac{14 kW}{12.040 kcal/h}$ **4.107,00**
84 / 0,35

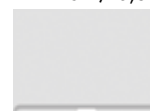

FTLR-8G
07230852

FRY-TOP GAS 1/2 RIGATO + 1/2 LISCIO, PIASTRA CM.75,5X55 - 2 ZONE DI COTTURA

EN Gas Fry-top 1/2 grooved + 1/2 smooth, plate cm.75,5x55 - 2 cooking areas • **DE** Gas-griddleplatte 1/2 gerillt + 1/2 glatt, platte cm.75,5x55 - 2 Heizzonen • **FR** Plaque gaz 1/2 nervurée + 1/2 lisse, plaque cm.75,5x55 - 2 zones de cuisson • **ES** Fry-top gas 1/2 estriado + 1/2 liso, plancha cm.75,5x55 - 2 zonas de cocción
cm. 80x 65x 29h

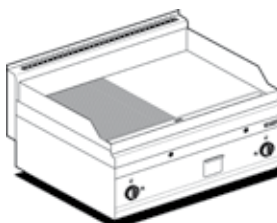

$\frac{14 kW}{12.040 kcal/h}$ **3.408,00**
84 / 0,35



FRY-TOP A GAS

MOD. _____
COD. _____

DESCRIZIONE/DESCRIPTION/BEZEICHNUNG/DESCRIPTION/DESCRIPCIÓN
DIMENSIONI/DIMENSIONS/ABMESSUNGEN/DIMENSIONS/DIMENSIONES

POTENZA/POWER/LEISTUNG/PUISSANCE/POTENCIA
VOLTAGGIO/VOLTAGE/SPANNUNG/VOLTAGE/VOLTAJE

14 kW
12.040 kcal/h

PREZZO/PRICE
PREIS/PRIX/PRECIO
KG / M³



FTLR-8GS
07230855

FRY-TOP GAS 1/2 RIGATO + 1/2 LISCIO CROMATO SUPERCHROME (MOCA APPROVED, PIASTRA CM.75,5X55 - 2 ZONE DI COTTURA

EN Gas Fry-top 1/2 grooved + 1/2 smooth chromed griddle SUPERCHROME (Moca Approved), plate cm.75,5x55 - 2 cooking areas • **DE** Gas-griddleplatte 1/2 gerillt + 1/2 glatt hartverchromt SUPERCHROME (Moca Approved), platte cm.75,5x55 - 2 Heizzonen • **FR** Plaque gaz 1/2 nervurée + 1/2 lisse chromée SUPERCHROME (Moca Approved), plaque cm.75,5x55 - 2 zones de cuisson • **ES** Fry-top gas 1/2 estriado + 1/2 liso cromado SUPERCHROME (Moca Approved), plancha cm.75,5x55 - 2 zonas de cocción
cm. 80x 65x 29h

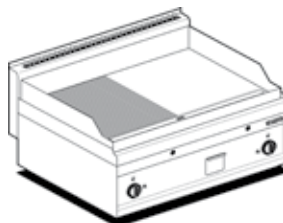

14 kW
12.040 kcal/h

4.309,00
84 / 0,35



PL-4
07010400

PIANO LAVORO CASSETTO CON 1 BACINELLA GN 1/1 15H PLASTICA.

EN Worktop - Drawer with 1 plastic container GN 1/1 15h • **DE** Arbeitsplatte - Schublade mit 1 GN 1/1 15h Kunststoffbehälter • **FR** Plan de travail - Tiroir avec bac en plastique GN 1/1 15h • **ES** Sobre de trabajo - Cajón con 1 contenedor GN 1/1 15h plástico
cm. 40x 65x 29h

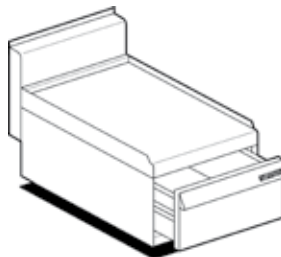

732,00
25 / 0,18

PL-6
07010600

PIANO LAVORO - CASSETTO CON 2 BACINELLE: 1 GN 1/1 15H PLASTICA, 1 CM. 17X46,5X15H INOX.

EN Worktop - Drawer with 2 containers: 1 GN 1/1 15h plastic, 1 cm. 17x46,5x15h inox. • **DE** Arbeitsplatte - Schublade mit 2 Behältern: 1 GN 1/1 15h aus Kunststoff, 1 cm. 17x46,5x15h aus Edelstahl. • **FR** Plan de travail - Tiroir avec 2 bacs: 1 GN 1/1 en plastique, 1 cm. 17x46,5x15h en acier inoxydable • **ES** Sobre de trabajo - Cajón con 2 contenedores: 1 GN 1/1 15h plástico, 1 cm. 17x46,5x15h inox
cm. 60x 65x 29h



837,00
34 / 0,27

PL-8
07010800

PIANO LAVORO CASSETTO CON 2 BACINELLE GN 1/1 15H PLASTICA.

EN Worktop - Drawer with 2 plastic containers GN 1/1 15h • **DE** Arbeitsplatte - Schublade mit 2 GN 1/1 15h Kunststoffbehältern • **FR** Plan de travail - Tiroir avec 2 bacs en plastique GN 1/1 15h • **ES** Sobre de trabajo - Cajón con 2 contenedores GN 1/1 15h plástico
cm. 80x 65x 29h



LA-6
07020600

LAVELLO RUBINETTO A LEVA - VASCA CM. 40X40X15H

EN Sink unit - Lever type tap - Bowl cm. 40x40x15h • **DE** Spülbecken - Einhebel-Mischbatterie Becken cm. 40x40x15h • **FR** Bac-évier avec robinetterie - Bac cm. 40x40x15h • **ES** Fregadero - Grifa a palanca - Pileta cm. 40x40x15h
cm. 60x 65x 29h

998,00
25 / 0,27

M-4
07420400

MOBILE BASE A GIORNO

EN Open stand • **DE** Unterschrank offen • **FR** Placard ouvert • **ES** Mueble base abierto
cm. 40x 53,5x 58h



449,00
15 / 0,16

M-6
07420600

cm. 60x 53,5x 58h

629,00
19 / 0,24

M-8
07420800

cm. 80x 53,5x 58h

713,00
22 / 0,31

MOBILI BASE

MOD. _____
COD. _____

DESCRIZIONE/DESCRIPTION/BEZEICHNUNG/DESCRIPTION/DESCRIPCIÓN
DIMENSIONI/DIMENSIONS/ABMESSUNGEN/DIMENSIONS/DIMENSIONES

POTENZA/POWER/LEISTUNG/PUISSANCE/POTENCIA
VOLTAGGIO/VOLTAGE/SPANNUNG/VOLTAGE/VOLTAJE

↓ kW kcal/h
↑ kw V~ Hz

PREZZO/PRICE
PREIS/PRIX/PRECIO
KG / M³



M-10
07421000

cm. 100x 53,5x 58h



1.029,00
27 / 0,39

M-12
07421200

cm. 120x 53,5x 58h

1.277,00
31 / 0,47

MPS-12
07421232

BASE CON PORTE SCORREVOLI

EN Stand with sliding doors • DE Unterschrank mit Schiebetüren • FR Placard avec portes coulissantes • ES Base con puertas corredizas
cm. 120x 56,5x 58h

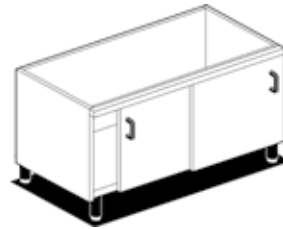

1.546,00
43 / 0,47

MPS-16
07421632

cm. 160x 56,5x 58h

1.748,00
60 / 0,73

MPS-20
07422032

cm. 200x 56,5x 58h

1.980,00
67 / 0,91

S-4
07410400

CAVALLETTO BASE

EN Stand • DE Untergestell • FR Piedement simple • ES Soporte base
cm. 40x 53,5x 58h

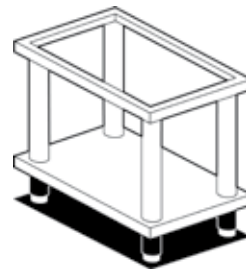

421,00
19.5 / 0,16

S-6
07410600

cm. 60x 53,5x 58h

471,00
23 / 0,24

S-8
07410800

cm. 80x 53,5x 58h

556,00
26 / 0,31

S-10
07411000

cm. 100x 53,5x 58h

633,00
29 / 0,39

PM-3DX
07430300

PORTA 300 DX

EN R/h door 300 • DE Flügeltür 300 rechts • FR Porte droite 300
• ES Puerta 300 derecha
cm. 29,5x 2,5x 45h



202,00
2.5 / 0,01

PM-4DX
07430400

PORTA 400 DX

EN R/h door 400 • DE Flügeltür 400 rechts • FR Porte droite 400
• ES Puerta 400 derecha
cm. 39,5x 2,5x 45h

211,00
3.5 / 0,02

PM-3SX
07430301

PORTA 300 SX

EN L/h door 300 • DE Flügeltür 300 links • FR Porte gauche 300
• ES Puerta 300 izq.
cm. 29,5x 2,5x 45h



202,00
2.5 / 0,01

PM-4SX
07430401

PORTA 400 SX

EN L/h door 400 • DE Flügeltür 400 links • FR Porte gauche 400
• ES Puerta 400 izq.
cm. 39,5x 2,5x 45h

211,00
3.5 / 0,02

ACCESSORI

MOD. _____
COD. _____

DESCRIZIONE/DESCRIPTION/BEZEICHNUNG/DESCRIPTION/DESCRIPCIÓN
DIMENSIONI/DIMENSIONS/ABMESSUNGEN/DIMENSIONS/DIMENSIONES

POTENZA/POWER/LEISTUNG/PUISSANCE/POTENCIA
VOLTAGGIO/VOLTAGE/SPANNUNG/VOLTAGE/VOLTAJE

⚡ kW kcal/h
⚡ kW V~ Hz

PREZZO/PRICE
PREIS/PRIX/PRECIO
KG / M³



C-4
07440420

CASSETTIERA 400 N. 2 CASSETTI CON 2 BACINELLE GN 1/1 15H IN PLASTICA, GUIDE TELESCOPICHE.

EN Drawer set 400 - N. 2 drawers with 2 GN 1/1 15h plastic containers, telescopic guides • **DE** Schubladen 400 - N. 2 Schubladen mit 2 GN 1/1 15h Kunststoffbehältern Telescopeinführungen • **FR** Tiroirs pour meuble de 400 - N. 2 tiroirs avec 2 bacs en plastique GN 1/1 15h guides télescopiques • **ES** Cajonera 400 - N. 2 cajones con 2 contenedores GN 1/1 15h de plástico, guías telescópicas.
cm. 39,5x 56x 45h

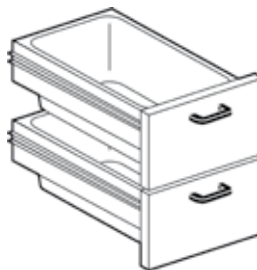

709,00
18 / 0,16

C-6
07440620

CASSETTIERA 600 - N. 2 CASSETTI CON 4 BACINELLE N. 2 GN 1/1 15H IN PLASTICA - N. 2 CM. 17X46,5X15H INOX - GUIDE TELESCOPICHE.

EN Drawer set 600 - N. 2 drawers with 4 containers N. 2 GN 1/1 15h in plastic - N. 2 cm. 17x46,5x45h inox - Telescopic guides. • **DE** Schubladen 600 - N. 2 Schubladen mit 4 Behältern N. 2 GN 1/1 15h aus Kunststoff - N. 2 cm. 17x46,5x45h aus Edelstahl - Telescopeinführungen • **FR** Tiroirs pour meuble de 600 - N. 2 tiroirs avec 4 bacs: N. 2 GN 1/1 15h en plastique, N. 2 cm. 17x46,5x45h en acier inoxydable, guides télescopiques. • **ES** Cajonera 600 - N. 2 cajones con 4 contenedores, N. 2 GN 1/1 15h de plástico, N. 2 cm 17x46,5x45h inox, guías telescópicas.
cm. 59,5x 56x 45h

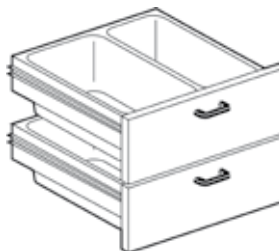

842,00
24 / 0,24

C-8
07440820

CASSETTIERA 800 N. 2 CASSETTI CON 4 BACINELLE GN 1/1 15H IN PLASTICA, GUIDE TELESCOPICHE.

EN Drawer set 800 - N. 2 drawers with 4 GN 1/1 15h plastic containers, telescopic guides • **DE** Schubladen 800 - N. 2 Schubladen mit 4 GN 1/1 15h Kunststoffbehältern Telescopeinführungen • **FR** Tiroirs pour meuble de 800 - N. 2 tiroirs avec 4 bacs en plastique GN 1/1 15h guides télescopiques • **ES** Cajonera 800 - N. 2 cajones con 4 contenedores GN 1/1 15h de plástico, guías telescópicas.
cm. 79,5x 56x 45h



1.105,00
26 / 0,31

R-4
07450400

RIPIANO 400

EN Shelf 400 • **DE** Abstellbrett 400 • **FR** Etagère 400 • **ES** Estante 400
cm. 35x 53x 2h



126,00
1.5 / 0,01

R-6
07450600

RIPIANO 600

EN Shelf 600 • **DE** Abstellbrett 600 • **FR** Etagère 600 • **ES** Estante 600
cm. 55x 53x 2h



143,00
2 / 0,01

R-8
07450800

RIPIANO 800

EN Shelf 800 • **DE** Abstellbrett 800 • **FR** Etagère 800 • **ES** Estante 800
cm. 75x 53x 2h



159,00
2.5 / 0,02

544023800 RASCHIETTO PER PIASTRA RIGATA

EN Scraper for gooved plate • **DE** Schaber für gerillte Kochplatte • **FR** Racloir pour plaque nervurée • **ES** Rasqueta para placa ranurada



64,00
/ 1,00

CG-65
07560000

COPRIGIUNTO

EN Joint cover • **DE** Klemmsteg • **FR** Couvre-joint • **ES** Cubre junta
cm. 0,7x 58x 1,2h

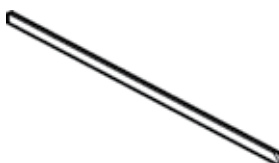

40,00
0.1 / 0,00

ACCESSORI

MOD. _____
COD. _____

DESCRIZIONE/DESCRIPTION/BEZEICHNUNG/DESCRIPTION/DESCRIPCIÓN
DIMENSIONI/DIMENSIONS/ABMESSUNGEN/DIMENSIONS/DIMENSIONES

POTENZA/POWER/LEISTUNG/PUISSANCE/POTENCIA
VOLTAGGIO/VOLTAGE/SPANNUNG/VOLTAGE/VOLTAJE

⚡ kW kcal/h
⚡ kw V~ Hz

PREZZO/PRICE
PREIS/PRIX/PRECIO
KG / M³

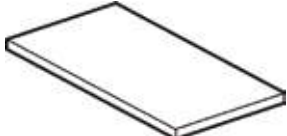

TG-4 07580400	TAGLIERE PLASTICA EN Plastic chopping-board • DE Schneidebrett • FR Plan de decoupe • ES Picador de plástico cm. 39x 58x 2,5h		157,00 6 / 0,01
TG-6 07580600	cm. 59x 58x 2,5h		232,00 9 / 0,02
TG-8 07580800	cm. 79x 58x 2,5h		300,00 11 / 0,02
TG-10 07581000	cm. 99x 58x 2,5h		323,00 14 / 0,02

06290600	COPERCHIO (BR-6) EN Lid (BR-6) • DE Deckel (BR-6) • FR Couvercle (BR-6) • ES Tapa (BR-6) cm. 51x 42x 3h		139,00 3 / 0,02
-----------------	---	--	---------------------------

PLF 07590401	PIASTRA LISCIA PER GRIGLIA IN GHISA EN Smooth griddle plate for cast iron grid • DE Fortkochplatte glatt für Gusseisen Rost • FR Plaque lisse pour la grille en fonte • ES Plancha lisa para rejilla de hierro fundido cm. 35x 27		190,00 9 / 0,01
------------------------	---	--	---------------------------

PLF/2 07590421	PIASTRA LISCIA 2 FUOCHI PER GRIGLIA IN GHISA EN Smooth griddle plate 2 burners for cast iron grid • DE Fortkochplatte glatt 2 Kochstellen für Gusseisen Rost • FR Plaque lisse 2 feux pour la grille en fonte • ES Plancha lisa 2 quemadores para rejilla de hierro fundido cm. 35x 57		375,00 18 / 0,01
--------------------------	--	--	----------------------------

PRF 07590403	PIASTRA RIGATA PER GRIGLIA IN GHISA EN Grooved griddle plate for cast iron grid • DE Fortkochplatte gerillt für Gusseisen Rost • FR Plaque nervurée pour la grille en fonte • ES Plancha estriada para rejilla de hierro fundido cm. 35x 27		254,00 9 / 0,01
------------------------	---	--	---------------------------

PRF/2 07590423	PIASTRA RIGATA 2 FUOCHI PER GRIGLIA IN GHISA EN Grooved griddle plate 2 burners for cast iron grid • DE Fortkochplatte gerillt 2 Kochstellen für Gusseisen Rost • FR Plaque nervurée 2 feux pour la grille en fonte • ES Plancha estriada 2 quemadores para rejilla de hierro fundido cm. 35x 57		417,00 18 / 0,01
--------------------------	--	--	----------------------------

533009200	GRIGLIA DI RIDUZIONE EN Reduction • DE Reduzierstern • FR Grille de réduction • ES Rejilla de reducción cm. 25x 25		40,00 0,2 / 0,00
------------------	--	--	----------------------------

MOD. _____
COD. _____

DESCRIZIONE/DESCRIPTION/BEZEICHNUNG/DESCRIPTION/DESCRIPCIÓN
DIMENSIONI/DIMENSIONS/ABMESSUNGEN/DIMENSIONS/DIMENSIONES

POTENZA/POWER/LEISTUNG/PUISSANCE/POTENCIA
VOLTAGGIO/VOLTAGE/SPANNUNG/VOLTAGE/VOLTAJE

↓ kW kcal/h
↗ kW V~ Hz

PREZZO/PRICE
PREIS/PRIX/PRECIO
KG / M³



544439900 ANELLO PER WOK - SOLO PER GRIGLIE IN GHISA

EN Wok ring - only for cast iron grills • **DE** Wok Aufsatzring - nur für Roste aus Gusseisen • **FR** Anneau Wok - seulement pour grilles en fonte
• **ES** Anillo Wok - solo para parrilas de hierro colado
cm. Ø 22,5x 3,5h



157,00
2 / 0,00

D-8
07470000

DIVISORIO NECESSARIO PER APPLICARE CASSETTIERA C-4 SU MOBILE M-8

EN Partition - for installation of a C-4 on a stand M-8 • **DE** Trennwand - Um ein C-4 an einem Unterschrank M-8 einzubauen • **FR** Separation - Pour l'installation de C-4 sur placard M-8 • **ES** Divisorio - Necesario para aplicar cajoneras C-4 en mueble M-8
cm. 5x 53,5x 38,5h

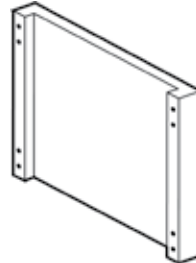

159,00
2 / 0,02

PT
07460002

PORTATEGLIE VANO 400/600 (GN-1/1) 4 RIPIANI INT. 9 CM.

EN Frame for plates 400/600 (GN-1/1) - N. 4 shelves, wheel-base 9 cm. • **DE** Auflangeschienen für bleche 400/600 (GN-1/1) N. 4 Etagen, Abstand 9 cm. • **FR** Kit porte-plaques 400/600 (GN-1/1) - N. 4 étagères; 9 cm. • **ES** Portacazuelas 400/600 (GN-1/1) - N. 4 estantes, int. 9 cm.

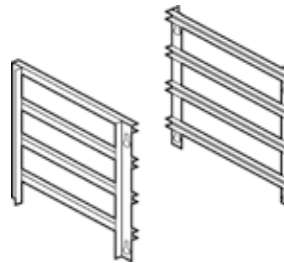

456,00
2 / 0,01

07570400 GRIGLIA PER CARNI GRASSE REGOLABILE (CW-4)

EN Adjustable grill for meat (CW-4) • **DE** Einstellbarer Fleischrost (CW-4) • **FR** Grille cannelée à gorges, réglable (CW-4) • **ES** Parrilla para carnes grasas regulable (CW-4)
cm. 38x 47



249,00
2.5 / 0,03

06300600 GRIGLIA PER CARNI GRASSE REGOLABILE (CW-6)

EN Adjustable grill for meat (CW-6) • **DE** Einstellbare Fleischrost (CW-6) • **FR** Grille cannelée réglable à gorges (CW-6) • **ES** Parrilla para carnes grasas regulable (CW-6)
cm. 28x 47



242,00
2 / 0,02

531048000 CESTO 1/6 PER CPM-6G

EN Basket 1/6 for CPM-6G • **DE** Korb 1/6 für CPM-6G • **FR** Panier 1/6 pour CPM-6G • **ES** Cesta 1/6 para CPM-6G
cm. 13,5x 16x 21,5h



94,00
1 / 0,02

531064300 CESTO 1/4 PER CPM-6G

EN Basket 1/4 for CPM-6G • **DE** Korb 1/4 für CPM-6G • **FR** Panier 1/4 pour CPM-6G • **ES** Cesta 1/4 para CPM-6G
cm. 11,5x 29x 20h

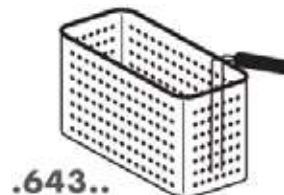

120,00
1,2 / 0,04

.643..

ACCESSORI CUOCIPASTA

MOD. _____
COD. _____

DESCRIZIONE/DESCRIPTION/BEZEICHNUNG/DESCRIPTION/DESCRIPCIÓN
DIMENSIONI/DIMENSIONS/ABMESSUNGEN/DIMENSIONS/DIMENSIONES

POTENZA/POWER/LEISTUNG/PUISSANCE/POTENCIA
VOLTAGGIO/VOLTAGE/SPANNUNG/VOLTAGE/VOLTAJE

⚡ kW kcal/h
⚡ kw V~ Hz

PREZZO/PRICE
PREIS/PRIX/PRECIO
KG / M³



531018700 CESTO CON GANCIO 1/4 PER CPM-6G

EN Basket with hook 1/4 for CPM-6G • **DE** Korb mit Haken 1/4 für CPM-6G • **FR** Panier avec crochet 1/4 pour CPM-6G • **ES** Cesta con gancho 1/4 para CPM-6G
cm. 11x 26x 20h



121,00
1,2 / 0,04

531069500 SUPPORTO PER CESTI CON GANCIO PER CPM-6G

EN support for baskets with hook for CPM-6G • **DE** Unterstützung für Körbe mit Haken für CPM-6G • **FR** soutien pour les paniers avec crochet pour CPM-6G • **ES** soporte para cestas con gancho para CPM-6G
cm. 50x 29x 39h



181,00
4 / 0,08

531043900 CESTO 1/1 (FP-6E)

EN basket 1/1 (FP-6E) • **DE** Fritierkorb 1/1 (FP-6E) • **FR** Panier 1/1 (FP-6E) • **ES** cesta 1/1 (FP-6E)
cm. 46x 30x 10h



157,00
3 / 0,06

531024300 CESTO 1/1 (FP-6G)

EN basket 1/1 (FP-6G) • **DE** Fritierkorb 1/1 (FP-6G) • **FR** Panier 1/1 (FP-6G) • **ES** cesta 1/1 (FP-6G)
cm. 42,5x 31x 10h



155,00
3 / 0,06

531013200 CESTO 1/2 (FQ-4-6) 1/4 (FP-6E)

EN basket 1/2 (FQ-4-6) 1/4 (FP-6E) • **DE** Fritierkorb 1/2 (FQ-4-6) 1/4 (FP-6E) • **FR** Panier 1/2 (FQ-4-6) 1/4 (FP-6E) • **ES** cesta 1/2 (FQ-4-6) 1/4 (FP-6E)
cm. 10x 30x 12h



58,00
0,7 / 0,03

531013500 CESTO 1/2 (FQM-4G)

EN basket 1/2 (FQM-4G) • **DE** Fritierkorb 1/2 (FQM-4G) • **FR** Panier 1/2 (FQM-4G) • **ES** cesta 1/2 (FQM-4G)
cm. 14x 33x 12h

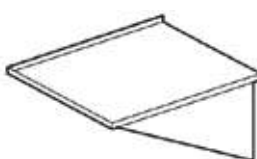

71,00
0,8 / 0,04

06280600 SCIVOLO (FP-6E)

EN Slide (FP-6E) • **DE** Rutsche (FP-6E) • **FR** Goulotte (FP-6E) • **ES** Deslizador (FP-6E)
cm. 60x 34

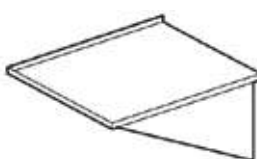

145,00
4 / 0,05

07600600 SCIVOLO (FP-6G)

EN Slide (FP-6G) • **DE** Rutsche (FP-6G) • **FR** Goulotte (FP-6G) • **ES** Deslizador (FP-6G)
cm. 55x 34

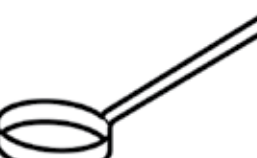

143,00
4 / 0,05

FU-1X7

05281700

FORMA PER UOVA Ø 7

EN Egg poachers Ø 7 • **DE** Eierformer Ø 7 • **FR** Forme a oeuf Ø 7 • **ES** Molde para huevos Ø 7

21,00
1 / 0,00

FU-1X9

05281900

FORMA PER UOVA Ø 9

EN Egg poachers Ø 9 • **DE** Eierformer Ø 9 • **FR** Forme a oeuf Ø 9 • **ES** Molde para huevos Ø 9

25,00
1 / 0,00

ACCESSORI

MOD.
COD.

DESCRIZIONE/DESCRIPTION/BEZEICHNUNG/DESCRIPTION/DESCRIPCIÓN
DIMENSIONI/DIMENSIONS/ABMESSUNGEN/DIMENSIONS/DIMENSIONES

POTENZA/POWER/LEISTUNG/PUISSANCE/POTENCIA
VOLTAGGIO/VOLTAGE/SPANNUNG/VOLTAGE/VOLTAJE

$\frac{kW}{kcal/h}$ $\frac{kw}{V\sim}$
Hz

PREZZO/PRICE
PREIS/PRIX/PRECIO
KG / M³



FU-2X7
05282700

FORMA PER UOVA 2XØ 7
EN Egg poachers Ø 7 • **DE** Eierformer Ø 7 • **FR** Forme a oeuf Ø 7
• **ES** Molde para huevos Ø 7



35,00
1.5 / 0,00

FU-2X9
05282900

FORMA PER UOVA 2XØ 9
EN Egg poachers Ø 9 • **DE** Eierformer Ø 9 • **FR** Forme a oeuf Ø 9
• **ES** Molde para huevos Ø 9

40,00
1.5 / 0,00

FU-3X7
05283700

FORMA PER UOVA 3XØ 7
EN Egg poachers Ø 7 • **DE** Eierformer Ø 7 • **FR** Forme a oeuf Ø 7
• **ES** Molde para huevos Ø 7



47,00
2 / 0,00

FU-3X9
05283900

FORMA PER UOVA 3XØ 9
EN Egg poachers Ø 9 • **DE** Eierformer Ø 9 • **FR** Forme a oeuf Ø 9
• **ES** Molde para huevos Ø 9

50,00
2 / 0,00

SUPERLOTUS 70



CUCINE ELETTRICHE

MOD. _____
COD. _____

DESCRIZIONE/DESCRIPTION/BEZEICHNUNG/DESCRIPTION/DESCRIPCIÓN
DIMENSIONI/DIMENSIONS/ABMESSUNGEN/DIMENSIONS/DIMENSIONES

POTENZA/POWER/LEISTUNG/PUISSANCE/POTENCIA
VOLTAGGIO/VOLTAGE/SPANNUNG/VOLTAGE/VOLTAJE

⚡ kW kcal/h
⚡ kW V~ Hz

PREZZO/PRICE
PREIS/PRIX/PRECIO
KG / M³



CF4-78ET
08660830

CUCINA 4 PIASTRE - FORNO ELETTRICO STATICO CM. 67X55X34H, TEMP: 50÷300°C, CON 1 GRIGLIA CM.65X53 GN2/1 (INCLUSA 1 TESTATA CHIUSURA PIANO MOD.TPA-7)
EN Electric range - N. 4 plates Traditional electric oven cm. 67x55x34h, temp: 50÷300°C, with 1 grid cm.65x53 GN2/1 (included 1 Head end filler strip mod.TPA-7) • **DE** Elektroherd - N. 4 Kochplatten Statischer Elektro-Backofen cm. 67x55x34h, temp: 50÷300°C, mit 1 Rost cm.65x53 GN2/1 (inbegriffen 1 Abschluss-Element mod.TPA-7) • **FR** Fourneau électrique - N. 4 plaques Four électrique statique cm. 67x55x34h, temp: 50÷300°C avec 1 grille cm.65x53 GN2/1 (inclus 1 Élément de jonction top mod.TPA-7) • **ES** Cocina eléctrica - N. 4 planchas Horno eléctrico estático cm. 67x55x34h, temp: 50÷300°C, con 1 parilla cm.65x53 GN2/1 (incluida 1 Chapa de cierre para top mod.TPA-7)
cm. 80x 70,5x 90h



⚡ 15,4 kW
400V~3N 112 / 0,71
50/60 Hz

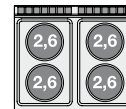

CFV4-78ET
08660835

CUCINA 4 PIASTRE - FORNO ELETTRICO VENTILATO CM. 55X36X34H, TEMP: 50÷300°C, CON 1 GRIGLIA CM.53X32,5 GN1/1 (INCLUSA 1 TESTATA CHIUSURA PIANO MOD.TPA-7)
EN Electric range - N. 4 plates - electric fan oven cm. 55x36x34h, temp: 50÷300°C, with 1 grid cm.53x32,5 GN1/1 (included 1 Head end filler strip mod.TPA-7) • **DE** Elektroherd - N. 4 Kochplatten - Elektro-Heißluftofen cm. 55x36x34h, temp: 50÷300°C, mit 1 Rost cm.53x32,5 GN1/1 (inbegriffen 1 Abschluss-Element mod.TPA-7) • **FR** Fourneau électrique - N. 4 plaques Four à chaleur tournante électrique cm. 55x36x34h, temp: 50÷300°C avec 1 grille cm.53x32,5 GN1/1 (inclus 1 Élément de jonction top mod.TPA-7) • **ES** Cocina eléctrica - N. 4 planchas - Horno eléctrico ventilado cm. 55x36x34h, temp: 50÷300°C, con 1 parilla cm.53x32,5 GN1/1 (incluida 1 Chapa de cierre para top mod.TPA-7)
cm. 80x 70,5x 90h

⚡ 15,72 kW
400V~3N 112 / 0,71
50/60 Hz

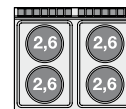

CFQ4-78ET
08660831

CUCINA 4 PIASTRE QUADRE - FORNO ELETTRICO STATICO CM. 67X55X34H, TEMP: 50÷300°C, CON 1 GRIGLIA CM.65X53 GN2/1 (INCLUSA 1 TESTATA CHIUSURA PIANO MOD.TPA-7)
EN Electric range - N. 4 square plates Traditional electric oven cm. 67x55x34h, temp: 50÷300°C, with 1 grid cm.65x53 GN2/1 (included 1 Head end filler strip mod.TPA-7) • **DE** Elektroherd - N. 4 quadratischen Platten - Statischer Elektro-Backofen cm. 67x55x34h, temp: 50÷300°C, mit 1 Rost cm.65x53 GN2/1 (inbegriffen 1 Abschluss-Element mod.TPA-7) • **FR** Fourneau électrique - N. 4 plaques carrés - Four électrique statique cm. 67x55x34h, temp: 50÷300°C avec 1 grille cm.65x53 GN2/1 (inclus 1 Élément de jonction top mod.TPA-7) • **ES** Cocina eléctrica - N. 4 planchas cuadradas Horno eléctrico estático cm. 67x55x34h, temp: 50÷300°C, con 1 parilla cm.65x53 GN2/1 (incluida 1 Chapa de cierre para top mod.TPA-7)
cm. 80x 70,5x 90h



⚡ 15,4 kW
400V~3N 120 / 0,71
50/60 Hz

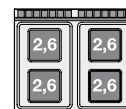

CFVQ4-78ET
08660836

CUCINA 4 PIASTRE QUADRE - FORNO ELETTRICO VENTILATO CM. 55X36X34H, TEMP: 50÷300°C, CON 1 GRIGLIA CM.53X32,5 GN1/1 (INCLUSA 1 TESTATA CHIUSURA PIANO MOD.TPA-7)
EN Electric range - N. 4 square plates - electric fan oven cm. 55x36x34h, temp: 50÷300°C, with 1 grid cm.53x32,5 GN1/1 (included 1 Head end filler strip mod.TPA-7) • **DE** Elektroherd - N. 4 quadratischen Platten - Elektro-Heißluftofen cm. 55x36x34h, temp: 50÷300°C, mit 1 Rost cm.53x32,5 GN1/1 (inbegriffen 1 Abschluss-Element mod.TPA-7) • **FR** Fourneau électrique - N. 4 plaques carrés - Four à chaleur tournante électrique cm. 55x36x34h, temp: 50÷300°C avec 1 grille cm.53x32,5 GN1/1 (inclus 1 Élément de jonction top mod.TPA-7) • **ES** Cocina eléctrica - N. 4 planchas cuadradas Horno eléctrico ventilado cm. 55x36x34h, temp: 50÷300°C, con 1 parilla cm.53x32,5 GN1/1 (incluida 1 Chapa de cierre para top mod.TPA-7)
cm. 80x 70,5x 90h

⚡ 15,72 kW
400V~3N 120 / 0,71
50/60 Hz

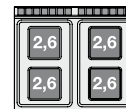

CUCINE ELETTRICHE

MOD. _____
COD. _____

DESCRIZIONE/DESCRIPTION/BEZEICHNUNG/DESCRIPTION/DESCRIPCIÓN
DIMENSIONI/DIMENSIONS/ABMESSUNGEN/DIMENSIONS/DIMENSIONES

POTENZA/POWER/LEISTUNG/PUISSANCE/POTENCIA
VOLTAGGIO/VOLTAGE/SPANNUNG/VOLTAGE/VOLTAJE

⚡ kW kcal/h
⚡ kw V~ Hz

PREZZO/PRICE
PREIS/PRIX/PRECIO
KG / M³



CFC4-78ET
08660832

CUCINA 4 PIASTRE VETROCERAMICA CM. 75 X 57 - FORNO ELETTRICO STATICO CM. 67X55X34H, TEMP: 50÷300°C, CON 1 GRIGLIA CM.65X53 GN2/1 (INCLUSA 1 TESTATA CHIUSURA PIANO MOD.TPA-7)

EN Electric range N. 4 plates ceramic glass cm. 75 x 57 - traditional electric oven cm. 67x55x34h, temp: 50÷300°C, with 1 grid cm.65x53 GN2/1 (included 1 Head end filler strip mod.TPA-7) • **DE** Elektroherd N. 4 Ceran-Kochplatten cm. 75 x 57 - Statischer Elektro-Backofen cm. 67x55x34h, temp: 50÷300°C, mit 1 Rost cm.65x53 GN2/1 (inbegriffen 1 Abschluss-Element mod.TPA-7) • **FR** Fourneau électrique N. 4 plaques vitroceramique cm. 75 x 57 - Four électrique statique cm. 67x55x34h, temp: 50÷300°C avec 1 grille cm.65x53 GN2/1 (inclus 1 Élément de jonction top mod.TPA-7) • **ES** Cocina eléctrica N. 4 planchas vitrocerámica cm. 75 x 57 - Horno eléctrico estático cm. 67x55x34h, temp: 50÷300°C, con 1 parilla cm.65x53 GN2/1 (incluida 1 Chapa de cierre para top mod.TPA-7)
cm. 80x 70,5x 90h



⚡ 15 kW
400V~3N
50/60 Hz

5.192,00
107 / 0,71

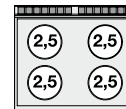

CFVC4-78ET
08660837

CUCINA 4 PIASTRE VETROCERAMICA CM. 75 X 57 - FORNO ELETTRICO VENTILATO CM. 55X36X34H, TEMP: 50÷300°C, CON 1 GRIGLIA CM.53X32,5 GN1/1 (INCLUSA 1 TESTATA CHIUSURA PIANO MOD.TPA-7)

EN Electric range N. 4 plates ceramic glass cm. 75 x 57 - electric fan oven cm. 55x36x34h, temp: 50÷300°C, with 1 grid cm.53x32,5 GN1/1 (included 1 Head end filler strip mod.TPA-7) • **DE** Elektroherd N. 4 Ceran-Kochplatten cm. 75 x 57 - Elektro-Heißluftofen cm. 55x36x34h, temp: 50÷300°C, mit 1 Rost cm.53x32,5 GN1/1 (inbegriffen 1 Abschluss-Element mod.TPA-7) • **FR** Fourneau électrique N. 4 plaques vitroceramique cm. 75 x 57 - Four à chaleur tournante électrique cm. 55x36x34h, temp: 50÷300°C avec 1 grille cm.53x32,5 GN1/1 (inclus 1 Élément de jonction top mod.TPA-7) • **ES** Cocina eléctrica N. 4 planchas vitrocerámica cm. 75 x 57 - Horno eléctrico ventilado cm. 55x36x34h, temp: 50÷300°C, con 1 parilla cm.53x32,5 GN1/1 (incluida 1 Chapa de cierre para top mod.TPA-7)
cm. 80x 70,5x 90h

⚡ 15,32 kW
400V~3N
50/60 Hz

5.586,00
107 / 0,71

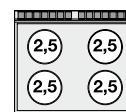

CF4-78GP
08680850

CUCINA 4 FUOCHI - FORNO A GAS STATICO CM. 67X55X34H, TEMP: 150÷300°C, CON 1 GRIGLIA CM.65X53 GN2/1 (INCLUSA 1 TESTATA CHIUSURA PIANO MOD.TPA-7)

EN Gas Range - N. 4 burners Traditional gas-oven cm. 67x55x34h, temp: 150÷300°C, with 1 grid cm.65x53 GN2/1 (included 1 Head end filler strip mod.TPA-7) • **DE** Gasherd - N. 4 Kochstellen Statischer Gas-Backofen cm. 67x55x34h, temp: 150÷300°C, mit 1 Rost cm.65x53 GN2/1 (inbegriffen 1 Abschluss-Element mod.TPA-7) • **FR** Cuisiniere gaz - N. 4 feux vifs Four à gaz statique cm. 67x55x34h, temp: 150÷300°C avec 1 grille cm.65x53 GN2/1 (inclus 1 Élément de jonction top mod.TPA-7) • **ES** Cocina a gas - N. 4 quemadores Horno a gas estático cm. 67x55x34h, temp: 150÷300°C, con 1 parilla cm.65x53 GN2/1 (incluida 1 Chapa de cierre para top mod.TPA-7)
cm. 80x 70,5x 90h



⚡ 29,3 kW
25.198 kcal/h

4.188,00
138 / 0,71

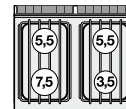

CF4-78GPE
08690860

CUCINA 4 FUOCHI - FORNO ELETTRICO STATICO CM. 67X55X34H, TEMP: 50÷300°C, CON 1 GRIGLIA CM.65X53 GN2/1 (INCLUSA 1 TESTATA CHIUSURA PIANO MOD.TPA-7)

EN Gas Range - N. 4 burners - traditional electric oven cm. 67x55x34h, temp: 50÷300°C, with 1 grid cm.65x53 GN2/1 (included 1 Head end filler strip mod.TPA-7) • **DE** Gasherd - N. 4 Kochstellen Statischer Elektro-Backofen cm. 67x55x34h, temp: 50÷300°C, mit 1 Rost cm.65x53 GN2/1 (inbegriffen 1 Abschluss-Element mod.TPA-7) • **FR** Cuisiniere gaz - N. 4 feux vifs Four électrique statique cm. 67x55x34h, temp: 50÷300°C avec 1 grille cm.65x53 GN2/1 (inclus 1 Élément de jonction top mod.TPA-7) • **ES** Cocina a gas - N. 4 quemadores Horno eléctrico estático cm. 67x55x34h, temp: 50÷300°C, con 1 parilla cm.65x53 GN2/1 (incluida 1 Chapa de cierre para top mod.TPA-7)
cm. 80x 70,5x 90h



⚡ 22 kW
18.920 kcal/h

4.188,00
132 / 0,71

⚡ 5 kW
400V~3N
50/60 Hz

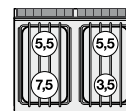

CUCINE A GAS CON FORNO ELETTRICO

MOD. _____
COD. _____

DESCRIZIONE/DESCRIPTION/BEZEICHNUNG/DESCRIPTION/DESCRIPCIÓN
DIMENSIONI/DIMENSIONS/ABMESSUNGEN/DIMENSIONS/DIMENSIONES

POTENZA/POWER/LEISTUNG/PUISSANCE/POTENCIA
VOLTAGGIO/VOLTAGE/SPANNUNG/VOLTAGE/VOLTAJE

⚡ kW _____
kcal/h _____
V~ _____
Hz _____

PREZZO/PRICE
PREIS/PRIX/PRECIO
KG / M³



CFV4-78GPE CUCINA 4 FUOCHI - FORNO ELETTRICO VENTILATO CM.
08690865 **55X36X34H, TEMP: 50÷300°C, CON 1 GRIGLIA CM.53X32,5 GN1/1 (INCLUSA 1 TESTATA CHIUSURA PIANO MOD.TPA-7)**
EN Gas Range - N. 4 burners - electric fan oven cm. 55x36x34h, temp: 50÷300°C, with 1 grid cm.53x32,5 GN1/1 (included 1 Head end filler strip mod.TPA-7) • **DE** Gasherd - N. 4 Kochstellen Elektro-Heißluftofen cm. 55x36x34h, temp: 50÷300°C, mit 1 Rost cm.53x32,5 GN1/1 (inbegriffen 1 Abschluss-Element mod.TPA-7) • **FR** Cuisiniere gaz - N. 4 feux vifs Four à chaleur tournante électrique cm. 55x36x34h, temp: 50÷300°C avec 1 grille cm.53x32,5 GN1/1 (inclus 1 Élément de jonction top mod.TPA-7) • **ES** Cocina a gas - N. 4 quemadores Horno eléctrico ventilado cm. 55x36x34h, temp: 50÷300°C, con 1 parilla cm.53x32,5 GN1/1 (incluida 1 Chapa de cierre para top mod.TPA-7)
cm. 80x 70,5x 90h



⚡ 22 kW _____ **4.591,00**
18.920 kcal/h 132 / 0,71

⚡ 5,32 kW _____
400V~3N _____
230V~3 _____
50/60 Hz _____

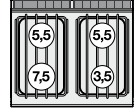

CFA4-78GP CUCINA ACQUA 4 FUOCHI - FORNO A GAS STATICO CM.
08750850 **67X55X34H, TEMP: 150÷300°C, CON 1 GRIGLIA CM.65X53 GN2/1 - RUBINETTO CARICO ACQUA, SFIORATORE (INCLUSA 1 TESTATA CHIUSURA PIANO MOD.TPA-7)**
EN Water range - N. 4 burners Traditional gas-oven cm. 67x55x34h, temp: 150÷300°C, with 1 grid cm.65x53 GN2/1 - Water loading tap + overflow device (included 1 Head end filler strip mod.TPA-7) • **DE** Wasser herd - N. 4 Kochstellen Statischer Gas-Backofen cm. 67x55x34h, temp: 150÷300°C, mit 1 Rost cm.65x53 GN2/1 - Wasserlauf-Hahn + Überlauf-Vorrichtung (inbegriffen 1 Abschluss-Element mod.TPA-7) • **FR** Cuisinière l'eau - N. 4 feux vifs Four à gaz statique cm. 67x55x34h, temp: 150÷300°C avec 1 grille cm.65x53 GN2/1 - Robinet d'arrivée d'eau trop plein (inclus 1 Élément de jonction top mod.TPA-7) • **ES** Cocina a agua - N. 4 quemadores Horno a gas estático cm. 67x55x34h, temp: 150÷300°C, con 1 parilla cm.65x53 GN2/1 - Grifo carga agua + vertedero (incluida 1 Chapa de cierre para top mod.TPA-7)
cm. 80x 70,5x 90h



⚡ 35,3 kW _____ **5.826,00**
30.358 kcal/h 138 / 0,71

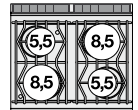

CF6-712ETV CUCINA 6 PIASTRE - FORNO ELETTRICO STATICO CM.
08661230 **67X55X34H, TEMP: 50÷300°C, CON 1 GRIGLIA CM.65X53 GN2/1 - VANO NEUTRO CON PORTA (INCLUSA 1 TESTATA CHIUSURA PIANO MOD.TPA-7)**
EN Electric range - N. 6 plates Traditional electric oven cm. 67x55x34h, temp: 50÷300°C, with 1 grid cm.65x53 GN2/1 - Neutral cabinet with door (included 1 Head end filler strip mod.TPA-7) • **DE** Elektroherd - N. 6 Kochplatten Statischer Elektro-Backofen cm. 67x55x34h, temp: 50÷300°C, mit 1 Rost cm.65x53 GN2/1 - Neutrales Schrankelement mit Tür (inbegriffen 1 Abschluss-Element mod.TPA-7) • **FR** Fourneau électrique - N. 6 plaques Four électrique statique cm. 67x55x34h, temp: 50÷300°C avec 1 grille cm.65x53 GN2/1 - Element neutre avec porte (inclus 1 Élément de jonction top mod.TPA-7) • **ES** Cocina eléctrica - N. 6 planchas Horno eléctrico estático cm. 67x55x34h, temp: 50÷300°C, con 1 parilla cm.65x53 GN2/1 - Armario neutro con puerta (incluida 1 Chapa de cierre para top mod.TPA-7)
cm. 120x 70,5x 90h



⚡ 20,6 kW _____ **4.884,00**
400V~3N _____ 134 / 1,05
50/60 Hz _____

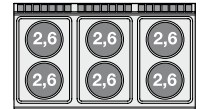

CFV6-712ETV CUCINA 6 PIASTRE - FORNO ELETTRICO VENTILATO CM.
08661235 **55X36X34H, TEMP: 50÷300°C, CON 1 GRIGLIA CM.53X32,5 GN1/1 - VANO NEUTRO CON PORTA (INCLUSA 1 TESTATA CHIUSURA PIANO MOD.TPA-7)**
EN Electric range - N. 6 plates electric fan oven cm. 55x36x34h, temp: 50÷300°C, with 1 grid cm.53x32,5 GN1/1 - Neutral cabinet with door (included 1 Head end filler strip mod.TPA-7) • **DE** Elektroherd - N. 6 Kochplatten Elektro-Heißluftofen cm. 55x36x34h, temp: 50÷300°C, mit 1 Rost cm.53x32,5 GN1/1 - Neutrales Schrankelement mit Tür (inbegriffen 1 Abschluss-Element mod.TPA-7) • **FR** Fourneau électrique - N. 6 plaques Four à chaleur tournante électrique cm. 55x36x34h, temp: 50÷300°C avec 1 grille cm.53x32,5 GN1/1 - Element neutre avec porte (inclus 1 Élément de jonction top mod.TPA-7) • **ES** Cocina eléctrica - N. 6 planchas Horno eléctrico ventilado cm. 55x36x34h, temp: 50÷300°C, con 1 parilla cm.53x32,5 GN1/1 - Armario neutro con puerta (incluida 1 Chapa de cierre para top mod.TPA-7)
cm. 120x 70,5x 90h

⚡ 20,92 kW _____ **5.274,00**
400V~3N _____ 134 / 1,05
50/60 Hz _____

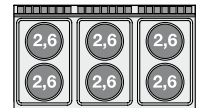

MOD. _____
COD. _____

DESCRIZIONE/DESCRIPTION/BEZEICHNUNG/DESCRIPTION/DESCRIPCIÓN
DIMENSIONI/DIMENSIONS/ABMESSUNGEN/DIMENSIONS/DIMENSIONES

POTENZA/POWER/LEISTUNG/PUISSANCE/POTENCIA
VOLTAGGIO/VOLTAGE/SPANNUNG/VOLTAGE/VOLTAJE

⚡ kW _____
kcal/h _____
V~ _____
Hz _____

PREZZO/PRICE _____
PREIS/PRIX/PRECIO _____
KG / M³ _____



CFQ6-712ETV CUCINA 6 PIASTRE QUADRE - FORNO ELETTRICO STATICO
08661231 **CM. 67X55X34H, TEMP: 50÷300°C, CON 1 GRIGLIA**
CM.65X53 GN2/1 - VANO NEUTRO CON PORTA (INCLUSA 1
TESTATA CHIUSURA PIANO MOD.TPA-7)

EN Electric range - N. 6 square plates Traditional electric oven cm. 67x55x34h, temp: 50÷300°C, with 1 grid cm.65x53 GN2/1 - Neutral cabinet with door (included 1 Head end filler strip mod.TPA-7) • **DE** Elektroherd - N. 6 quadratischen Platten Statischer Elektro-Backofen cm. 67x55x34h, temp: 50÷300°C, mit 1 Rost cm.65x53 GN2/1 - Neutrales Schrankelement mit Tür (inbegriffen 1 Abschluss-Element mod.TPA-7) • **FR** Fourneau électrique - N. 6 plaques carrés Four électrique statique cm. 67x55x34h, temp: 50÷300°C avec 1 grille cm.65x53 GN2/1 - Element neutre avec porte (inclus 1 Élément de jonction top mod.TPA-7) • **ES** Cocina eléctrica - N. 6 planchas cuadradas Horno eléctrico estático cm. 67x55x34h, temp: 50÷300°C, con 1 parilla cm.65x53 GN2/1 - Armario neutro con puerta (incluida 1 Chapa de cierre para top mod. TPA-7)
cm. 120x 70,5x 90h



⚡ 20,6 kW _____ **6.541,00**
400V~3N _____ 146 / 1,05
50/60 Hz

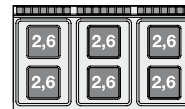

CFVQ6-712ETV CUCINA 6 PIASTRE QUADRE - FORNO ELETTRICO VENTILATO
08661236 **CM. 55X36X34H, TEMP: 50÷300°C, CON 1 GRIGLIA**
CM.53X32,5 GN1/1 - VANO NEUTRO CON PORTA (INCLUSA
1 TESTATA CHIUSURA PIANO MOD.TPA-7)

EN Electric range - N. 6 square plates electric fan oven cm. 55x36x34h, temp: 50÷300°C, with 1 grid cm.53x32,5 GN1/1 - Neutral cabinet with door (included 1 Head end filler strip mod.TPA-7) • **DE** Elektroherd - N. 6 quadratischen Platten Elektro-Heißluftofen cm. 55x36x34h, temp: 50÷300°C, mit 1 Rost cm.53x32,5 GN1/1 - Neutrales Schrankelement mit Tür (inbegriffen 1 Abschluss-Element mod.TPA-7) • **FR** Fourneau électrique - N. 6 plaques carrés Four à chaleur tournante électrique cm. 55x36x34h, temp: 50÷300°C avec 1 grille cm.53x32,5 GN1/1 - Element neutre avec porte (inclus 1 Élément de jonction top mod.TPA-7) • **ES** Cocina eléctrica - N. 6 planchas cuadradas Horno eléctrico ventilado cm. 55x36x34h, temp: 50÷300°C, con 1 parilla cm.53x32,5 GN1/1 - Armario neutro con puerta (incluida 1 Chapa de cierre para top mod. TPA-7)
cm. 120x 70,5x 90h

⚡ 20,92 kW _____ **6.928,00**
400V~3N _____ 146 / 1,05
50/60 Hz

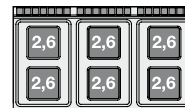

CF6-712ET CUCINA 6 PIASTRE FORNO ELETTRICO STATICO CM.
08661232 **107X55X34H, TEMP: 50÷300°C, CON 1 GRIGLIA**
CM.105X53 (INCLUSA 1 TESTATA CHIUSURA PIANO MOD.
TPA-7)

EN Electric Range - N. 6 plates Traditional electric oven cm. 107x55x34h, temp: 50÷300°C, with 1 grid cm.105x53 (included 1 Head end filler strip mod.TPA-7) • **DE** Elektroherd - N. 6 Kochplatten Statischer Elektro-Backofen cm. 107x55x34h, temp: 50÷300°C, mit 1 Rost cm.105x53 (inbegriffen 1 Abschluss-Element mod.TPA-7) • **FR** Fourneau électrique - N. 6 plaques Four électrique statique cm. 107x55x34h, temp: 50÷300°C, avec 1 grille cm.105x53 (inclus 1 Élément de jonction top mod.TPA-7) • **ES** Cocina eléctrica - N. 6 planchas Horno eléctrico estático cm. 107x55x34h, temp: 50÷300°C, con 1 parilla cm.105x53 (incluida 1 Chapa de cierre para top mod.TPA-7)
cm. 120x 70,5x 90h



⚡ 22,5 kW _____ **5.509,00**
400V~3N _____ 136 / 1,05
50/60 Hz



CFQ6-712ET CUCINA 6 PIASTRE QUADRE FORNO ELETTRICO STATICO
08661233 **CM. 107X55X34H, TEMP: 50÷300°C, CON 1 GRIGLIA**
CM.105X53 (INCLUSA 1 TESTATA CHIUSURA PIANO MOD.
TPA-7)

EN Electric Range - N. 6 square plates Traditional electric oven cm. 107x55x34h, temp: 50÷300°C, with 1 grid cm.105x53 (included 1 Head end filler strip mod.TPA-7) • **DE** Elektroherd - N. 6 quadratischen Platten Statischer Elektro-Backofen cm. 107x55x34h, temp: 50÷300°C, mit 1 Rost cm.105x53 (inbegriffen 1 Abschluss-Element mod.TPA-7) • **FR** Fourneau électrique - N. 6 plaques carrés Four électrique statique cm. 107x55x34h, temp: 50÷300°C, avec 1 grille cm.105x53 (inclus 1 Élément de jonction top mod.TPA-7) • **ES** Cocina eléctrica - N. 6 planchas cuadradas Horno eléctrico estático cm. 107x55x34h, temp: 50÷300°C, con 1 parilla cm.105x53 (incluida 1 Chapa de cierre para top mod.TPA-7)
cm. 120x 70,5x 90h



⚡ 22,5 kW _____ **7.071,00**
400V~3N _____ 148 / 1,05
50/60 Hz



CUCINE A GAS

MOD. _____
COD. _____

DESCRIZIONE/DESCRIPTION/BEZEICHNUNG/DESCRIPTION/DESCRIPCIÓN
DIMENSIONI/DIMENSIONS/ABMESSUNGEN/DIMENSIONS/DIMENSIONES

POTENZA/POWER/LEISTUNG/PUISSANCE/POTENCIA
VOLTAGGIO/VOLTAGE/SPANNUNG/VOLTAGE/VOLTAJE

⚡ kW _____
kcal/h _____
V~ _____
Hz _____

PREZZO/PRICE
PREIS/PRIX/PRECIO
KG / M³



CF6-712GPV CUCINA 6 FUOCHI FORNO A GAS STATICO CM. 67X55X34H, 08681251
TEMP: 150÷300°C, CON 1 GRIGLIA CM.65X53 GN2/1 - VANO NEUTRO CON PORTA (INCLUSA 1 TESTATA CHIUSURA PIANO MOD.TPA-7)

EN Gas Range - N. 6 burners Traditional gas-oven GN cm. 67x55x34h, temp: 150÷300°C, with 1 grid cm.65x53 GN2/1 - Neutral cabinet with door (included 1 Head end filler strip mod.TPA-7) • **DE** Gasherd - N. 6 Kochstellen - Statischer Gas-Backofen cm. 67x55x34h, temp: 150÷300°C, mit 1 Rost cm.65x53 GN2/1 - Neutrales Schrankelement mit Tür (inbegriffen 1 Abschluss-Element mod.TPA-7) • **FR** Cuisiniere Gaz - N. 6 feux vifs Four à gaz statique cm. 67x55x34h, temp: 150÷300°C avec 1 grille cm.65x53 GN2/1 - Élément neutre avec porte (inclus 1 Élément de jonction top mod.TPA-7) • **ES** Cocina a gas - N. 6 quemadores Horno a gas estático cm. 67x55x34h, temp: 150÷300°C, con 1 parilla cm.65x53 GN2/1 - Armario neutro con puerta (incluida 1 Chapa de cierre para top mod.TPA-7)
cm. 120x 70,5x 90h



⚡ 42,3 kW _____
36.378 kcal/h _____ **5.578,00**
178 / 1,05

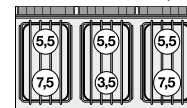

CF6-712GPEV CUCINA 6 FUOCHI - FORNO ELETTRICO STATICO CM. 08691261
67X55X34H, TEMP: 50÷300°C, CON 1 GRIGLIA CM.65X53 GN2/1 - VANO NEUTRO CON PORTA (INCLUSA 1 TESTATA CHIUSURA PIANO MOD.TPA-7)

EN Gas Range - N. 6 burners - tradiional electric oven cm. 67x55x34h, temp: 50÷300°C, with 1 grid cm.65x53 GN2/1 - Neutral cabinet with door (included 1 Head end filler strip mod.TPA-7) • **DE** Gasherd - N. 6 Kochstellen Statischer Elektro-Backofen cm. 67x55x34h, temp: 50÷300°C, mit 1 Rost cm.65x53 GN2/1 - Neutrales Schrankelement mit Tür (inbegriffen 1 Abschluss-Element mod.TPA-7) • **FR** Cuisiniere gaz - N. 6 feux vifs Four électrique statique cm. 67x55x34h, temp: 50÷300°C avec 1 grille cm.65x53 GN2/1 - Element neutre avec porte (inclus 1 Élément de jonction top mod.TPA-7) • **ES** Cocina a gas - N. 6 quemadores Horno eléctrico estático cm. 67x55x34h, temp: 50÷300°C, con 1 parilla cm.65x53 GN2/1 - Armario neutro con puerta (incluida 1 Chapa de cierre para top mod.TPA-7)
cm. 120x 70,5x 90h



⚡ 35 kW _____
30.100 kcal/h _____ **5.578,00**
177 / 1,05

⚡ 5 kW _____
400V~3N
50/60 Hz

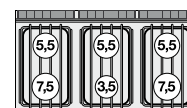

CFV6-712GPEV CUCINA 6 FUOCHI - FORNO ELETTRICO VENTILATO CM. 08691266
55X36X34H, TEMP: 50÷300°C, CON 1 GRIGLIA CM.53X32,5 GN1/1 - VANO NEUTRO CON PORTA (INCLUSA 1 TESTATA CHIUSURA PIANO MOD.TPA-7)

EN Gas Range - N. 6 burners - electric fan oven cm. 55x36x34h, temp: 50÷300°C, with 1 grid cm.53x32,5 GN1/1 - Neutral cabinet with door (included 1 Head end filler strip mod.TPA-7) • **DE** Gas Range - N. 6 burners - electric fan oven cm. 55x36x34h, temp: 50÷300°C, mit 1 Rost cm.53x32,5 GN1/1 - Neutral cabinet with door (inbegriffen 1 Abschluss-Element mod.TPA-7) • **FR** Gas Range - N. 6 burners - electric fan oven cm. 55x36x34h, temp: 50÷300°C avec 1 grille cm.53x32,5 GN1/1 - Neutral cabinet with door (inclus 1 Élément de jonction top mod.TPA-7) • **ES** Gas Range - N. 6 burners - electric fan oven cm. 55x36x34h, temp: 50÷300°C, con 1 parilla cm.53x32,5 GN1/1 - Neutral cabinet with door (incluida 1 Chapa de cierre para top mod.TPA-7)
cm. 120x 70,5x 90h

⚡ 35 kW _____
30.100 kcal/h _____ **5.950,00**
177 / 1,05

⚡ 5,32 kW _____
400V~3N
230V~3
50/60 Hz

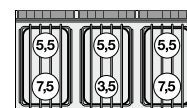

CFA6-712GPV CUCINA ACQUA 6 FUOCHI - FORNO A GAS STATICO CM. 08751251
67X55X34H, TEMP: 150÷300°C, CON 1 GRIGLIA CM.65X53 GN2/1 - VANO NEUTRO CON PORTA - RUBINETTO CARICO ACQUA, SFIORATORE (INCLUSA 1 TESTATA CHIUSURA PIANO MOD.TPA-7)

EN Water range - N. 6 burners - Traditional gas-oven cm. 67x55x34h, temp: 150÷300°C, with 1 grid cm.65x53 GN2/1 - Neutral cabinet with door - Water loading tap + overflow device (included 1 Head end filler strip mod.TPA-7) • **DE** Wasser herd - N. 6 Kochstellen - Statischer Gas-Backofen cm. 67x55x34h, temp: 150÷300°C, mit 1 Rost cm.65x53 GN2/1 - Neutrales Schrankelement mit Tür - Wasserlauf-Hahn + Überlauf-Vorrichtung (inbegriffen 1 Abschluss-Element mod.TPA-7) • **FR** Cuisiniere l'eau - N. 6 feux vifs Four à gaz statique cm. 67x55x34h, temp: 150÷300°C avec 1 grille cm.65x53 GN2/1 - Element neutre avec porte - Robinet d'arrivée d'eau trop plein (inclus 1 Élément de jonction top mod.TPA-7) • **ES** Cocina a agua N. 6 quemadores Horno a gas estático cm. 67x55x34h, temp: 150÷300°C, con 1 parilla cm.65x53 GN2/1 - Armario neutro con puerta - Grifo carga agua + vertedero (incluida 1 Chapa de cierre para top mod.TPA-7)
cm. 120x 70,5x 90h



⚡ 49,3 kW _____
42.398 kcal/h _____ **6.771,00**
178 / 1,05

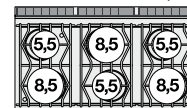

MOD. _____
COD. _____

DESCRIZIONE / DESCRIPTION / BEZEICHNUNG / DESCRIPTION / DESCRIPCIÓN
DIMENSIONI / DIMENSIONS / ABMESSUNGEN / DIMENSIONS / DIMENSIONES

POTENZA / POWER / LEISTUNG / PUISSANCE / POTENCIA
VOLTAGGIO / VOLTAGE / SPANNUNG / VOLTAGE / VOLTAJE

⚡ kW
kcal/h

PREZZO / PRICE
PREIS / PRIX / PRECIO
KG / M³



CF6-712GP
08681250

CUCINA 6 FUOCHI FORNO A GAS STATICO CM. 107X55X34H, TEMP: 150÷300°C, CON 1 GRIGLIA CM.105X53 (INCLUSA 1 TESTATA CHIUSURA PIANO MOD. TPA-7)

EN Gas Range - N. 6 burners Traditional gas-oven cm. 107x55x34h, temp: 150÷300°C, with 1 grid cm.105x53 (included 1 Head end filler strip mod.TPA-7) • **DE** Gasherd - N. 6 Kochstellen Statischer Gas-Backofen cm. 107x55x34h, temp: 150÷300°C, mit 1 Rost cm.105x53 (inbegriffen 1 Abschluss-Element mod.TPA-7) • **FR** Cuisiniere gaz - N. 6 feux vifs Four à gaz statique cm. 107x55x34h, temp: 150÷300°C, avec 1 grille cm.105x53 (inclus 1 Élément de jonction top mod.TPA-7) • **ES** Cocina a gas - N. 6 quemadores Horno a gas estático cm. 107x55x34h, temp: 150÷300°C, con 1 parilla cm.105x53 (incluida 1 Chapa de cierre para top mod.TPA-7)
cm. 120x 70,5x 90h



⚡ 46 kW
39.560 kcal/h

6.238,00
197 / 1,05

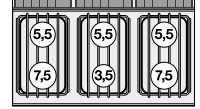

CF6-712GPE
08691260

CUCINA 6 FUOCHI FORNO ELETTRICO STATICO CM. 107X55X34H, TEMP: 50÷300°C, CON 1 GRIGLIA CM.105X53 (INCLUSA 1 TESTATA CHIUSURA PIANO MOD. TPA-7)

EN Gas Range - N. 6 burners Traditional electric oven cm. 107x55x34h, temp: 50÷300°C, with 1 grid cm.105x53 (included 1 Head end filler strip mod.TPA-7) • **DE** Gasherd - N. 6 Kochstellen Statischer Elektro-Backofen cm. 107x55x34h, temp: 50÷300°C, mit 1 Rost cm.105x53 (inbegriffen 1 Abschluss-Element mod.TPA-7) • **FR** Cuisiniere gaz - N. 6 feux vifs Four électrique statique cm. 107x55x34h, temp: 50÷300°C, avec 1 grille cm.105x53 (inclus 1 Élément de jonction top mod.TPA-7) • **ES** Cocina a gas - N. 6 quemadores Horno eléctrico estático cm. 107x55x34h, temp: 50÷300°C, con 1 parilla cm.105x53 (incluida 1 Chapa de cierre para top mod.TPA-7)
cm. 120x 70,5x 90h



⚡ 35 kW
30.100 kcal/h

6.238,00
190 / 1,05

⚡ 6,9 kW
400V~3N
50/60 Hz

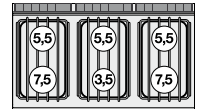

PC-74ET
08030430

PIANO COTTURA TRIFASE SU MOBILE A GIORNO - N. 2 PIASTRE (INCLUSA 1 TESTATA CHIUSURA PIANO MOD.TPA-7)

EN Boiling unit threephase on open cabinet - N. 2 plates (included 1 Head end filler strip mod.TPA-7) • **DE** Kochplatte dreiphasig mit offenem Unterbau N. 2 Kochplatten (inbegriffen 1 Abschluss-Element mod.TPA-7) • **FR** Rechaud électriques sur armoire ouvert - N. 2 plaques (inclus 1 Élément de jonction top mod.TPA-7) • **ES** Sobre de cocción trifásico sobre mueble abierto N. 2 planchas (incluida 1 Chapa de cierre para top mod.TPA-7)
cm. 40x 70,5x 90h



⚡ 5,2 kW
400V~2N
230V~3
230V~
50/60 Hz

1.230,00
42 / 0,37

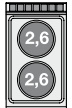

PC-78ET
08030830

PIANO COTTURA TRIFASE SU MOBILE A GIORNO N. 4 PIASTRE (INCLUSA 1 TESTATA CHIUSURA PIANO MOD.TPA-7)

EN Threephase boiling unit on open cabinet - N. 4 plates (included 1 Head end filler strip mod.TPA-7) • **DE** Kochplatte dreiphasig mit offenem Unterbau N. 4 Kochplatten (inbegriffen 1 Abschluss-Element mod.TPA-7) • **FR** Rechaud triphase sur armoire ouvert - N. 4 plaques (inclus 1 Élément de jonction top mod.TPA-7) • **ES** Sobre de cocción trifásico sobre mueble abierto N. 4 planchas (incluida 1 Chapa de cierre para top mod.TPA-7)
cm. 80x 70,5x 90h



⚡ 10,4 kW
400V~3N
230V~3
50/60 Hz

1.892,00
68 / 0,71

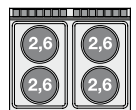

PC-712ET
08031230

PIANO COTTURA TRIFASE SU MOBILE A GIORNO N. 6 PIASTRE (INCLUSA 1 TESTATA CHIUSURA PIANO MOD.TPA-7)

EN Threephase boiling unit on open cabinet - N. 6 plates (included 1 Head end filler strip mod.TPA-7) • **DE** Kochplatte dreiphasig mit offenem Unterbau N. 6 Kochplatten (inbegriffen 1 Abschluss-Element mod.TPA-7) • **FR** Rechaud triphase sur armoire ouvert - N. 6 plaques (inclus 1 Élément de jonction top mod.TPA-7) • **ES** Sobre de cocción trifásico sobre mueble abierto N. 6 planchas (incluida 1 Chapa de cierre para top mod.TPA-7)
cm. 120x 70,5x 90h



⚡ 15,6 kW
400V~3N
230V~3
50/60 Hz

2.629,00
88 / 1,05

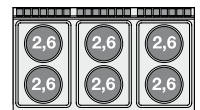

PIANI COTTURA ELETTRICI

MOD. _____
COD. _____

DESCRIZIONE/DESCRIPTION/BEZEICHNUNG/DESCRIPTION/DESCRIPCIÓN
DIMENSIONI/DIMENSIONS/ABMESSUNGEN/DIMENSIONS/DIMENSIONES

POTENZA/POWER/LEISTUNG/PUISSANCE/POTENCIA
VOLTAGGIO/VOLTAGE/SPANNUNG/VOLTAGE/VOLTAJE

⚡ kW _____
kcal/h _____
V~ _____
Hz _____

PREZZO/PRICE
PREIS/PRIX/PRECIO
KG / M³



PCC-74ET
08030431

**PIANO COTTURA TRIFASE SU MOBILE A GIORNO - N. 2
PIASTRE QUADRE (INCLUSA 1 TESTATA CHIUSURA PIANO
MOD.TPA-7)**

EN Boiling unit threephase on open cabinet - N. 2 square plates (included 1 Head end filler strip mod.TPA-7) • **DE** Kochplatte dreiphasig mit offenem Unterbau N. 2 quadratischen Platten (inbegriffen 1 Abschluss-Element mod.TPA-7) • **FR** Rechaud électriques sur armoire ouvert - N. 2 plaques carrés (inclus 1 Élément de jonction top mod.TPA-7) • **ES** Sobre de cocción trifásico sobre mueble abierto N. 2 planchas cuadradas (incluida 1 Chapa de cierre para top mod.TPA-7)
cm. 40x 70,5x 90h



⚡ 5,2 kW _____ **1.836,00**
400V~2N _____ 46 / 0,37
230V~3
230V~
50/60 Hz

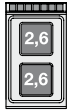

PCC-78ET
08030831

**PIANO COTTURA TRIFASE SU MOBILE A GIORNO - N. 4
PIASTRE QUADRE (INCLUSA 1 TESTATA CHIUSURA PIANO
MOD.TPA-7)**

EN Boiling unit threephase on open cabinet - N. 4 square plates (included 1 Head end filler strip mod.TPA-7) • **DE** Kochplatte dreiphasig mit offenem Unterbau N. 4 quadratischen Platten (inbegriffen 1 Abschluss-Element mod.TPA-7) • **FR** Rechaud électriques sur armoire ouvert - N. 4 plaques carrés (inclus 1 Élément de jonction top mod.TPA-7) • **ES** Sobre de cocción trifásico sobre mueble abierto N. 4 planchas cuadradas (incluida 1 Chapa de cierre para top mod.TPA-7)
cm. 80x 70,5x 90h



⚡ 10,4 kW _____ **3.189,00**
400V~3N _____ 71 / 0,71
230V~3
50/60 Hz

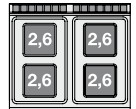

PCC-712ET
08031231

**PIANO COTTURA TRIFASE SU MOBILE A GIORNO - N. 6
PIASTRE QUADRE (INCLUSA 1 TESTATA CHIUSURA PIANO
MOD.TPA-7)**

EN Boiling unit threephase on open cabinet - N. 6 square plates (included 1 Head end filler strip mod.TPA-7) • **DE** Kochplatte dreiphasig mit offenem Unterbau N. 6 quadratischen Platten (inbegriffen 1 Abschluss-Element mod.TPA-7) • **FR** Rechaud électriques sur armoire ouvert - N. 6 plaques carrés (inclus 1 Élément de jonction top mod.TPA-7) • **ES** Sobre de cocción trifásico sobre mueble abierto N. 6 planchas cuadradas (incluida 1 Chapa de cierre para top mod.TPA-7)
cm. 120x 70,5x 90h



⚡ 15,6 kW _____ **4.546,00**
400V~3N _____ 103 / 1,05
230V~3
50/60 Hz



PCC-74ET
08030432

**PIANO COTTURA VETROCERAMICA TRIFASE SU MOBILE
A GIORNO - N. 2 ZONE - VETRO CM.35X57 (INCLUSA 1
TESTATA CHIUSURA PIANO MOD.TPA-7)**

EN Ceramic glass boiling unit on open cabinet - n. 2 zones - glass cm.35x57 (included 1 Head end filler strip mod.TPA-7) • **DE** Ceran-Kochplatte dreiphasig mit offenem Unterbau - 2 zonen - Glas 35x57 cm (inbegriffen 1 Abschluss-Element mod.TPA-7) • **FR** Plan de cuisson à vitroceramique triphasé sur armoire ouvert N. 2 zones - Verre cm.35x57 (inclus 1 Élément de jonction top mod.TPA-7) • **ES** Sobre de cocción trifásico vitrocerámica sobre mueble abierto - 2 zonas - vidrio cm.35x57 (incluida 1 Chapa de cierre para top mod.TPA-7)
cm. 40x 70,5x 90h



⚡ 5 kW _____ **2.286,00**
400V~2N _____ 41 / 0,37
230V~3
230V~
50/60 Hz

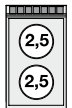

PCC-78ET
08030832

**PIANO COTTURA VETROCERAMICA TRIFASE SU MOBILE A
GIORNO - N. 4 ZONE - VETRO CM. 75X57 (INCLUSA 1
TESTATA CHIUSURA PIANO MOD.TPA-7)**

EN Ceramic glass boiling unit on open cabinet - n. 4 zones - glass cm. 75 x 57 (included 1 Head end filler strip mod.TPA-7) • **DE** Ceran-Kochplatte dreiphasig mit offenem Unterbau - 4 zonen - Glas 75x57 cm (inbegriffen 1 Abschluss-Element mod.TPA-7) • **FR** Plan de cuisson à vitroceramique triphasé sur armoire ouvert N. 4 zones - Verre cm 75x57 (inclus 1 Élément de jonction top mod.TPA-7) • **ES** Sobre de cocción trifásico vitrocerámica sobre mueble abierto - 4 zonas - vidrio cm. 75 x 57 (incluida 1 Chapa de cierre para top mod.TPA-7)
cm. 80x 70,5x 90h



⚡ 10 kW _____ **3.363,00**
400V~3N _____ 66 / 0,71
230V~3
50/60 Hz

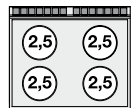

PCI-74ET
08030433

**PIANO COTTURA INDUZIONE TRIFASE - N. 2 ZONE - VETRO
CM.35X57 (INCLUSA 1 TESTATA CHIUSURA PIANO MOD.
TPA-7)**

EN Three-phase induction cooking - 2 zones - glass cm.35x57 (included 1 Head end filler strip mod.TPA-7) • **DE** Induktions-Kochplatte dreiphasig - 2 zonen - Glas 35x57 cm (inbegriffen 1 Abschluss-Element mod.TPA-7) • **FR** Plan de cuisson à induction triphasé N. 2 zones - Verre cm.35x57 (inclus 1 Élément de jonction top mod.TPA-7) • **ES** Encimera inducción trifásica - 2 zonas - Vidrio cm.35x57 (incluida 1 Chapa de cierre para top mod.TPA-7)
cm. 40x 70,5x 90h



⚡ 10 kW _____ **8.000,00**
400V~3 _____ 40 / 0,37
50/60 Hz

PIANI COTTURA A INDUZIONE

MOD. _____
COD. _____

DESCRIZIONE/DESCRIPTION/BEZEICHNUNG/DESCRIPTION/DESCRIPCIÓN
DIMENSIONI/DIMENSIONS/ABMESSUNGEN/DIMENSIONS/DIMENSIONES

POTENZA/POWER/LEISTUNG/PUISSANCE/POTENCIA
VOLTAGGIO/VOLTAGE/SPANNUNG/VOLTAGE/VOLTAJE

⚡ kW _____
kcal/h _____
V~ _____
Hz _____

PREZZO/PRICE
PREIS/PRIX/PRECIO
KG / M³



PCIW-74ET **PIANO COTTURA INDUZIONE TRIFASE "WOK" - N. 1 ZONA**
08030434 **- VETRO Ø 30 CM. (INCLUSA 1 TESTATA CHIUSURA PIANO MOD.TPA-7)**

EN Three-phase induction cooking "WOK" - 1 zone - glass Ø 30 cm (included 1 Head end filler strip mod.TPA-7) • **DE** Induktions-Kochplatte "WOK" dreiphasig - 1 zonen - Glas Ø 30 cm (inbegriffen 1 Abschluss-Element mod.TPA-7) • **FR** Plan de cuisson à induction "WOK" triphasé N. 1 zone - Verre cm Ø 30 (inclus 1 Élément de jonction top mod.TPA-7) • **ES** Encimera inducción "WOK" trifásica - 1 zona - Vidrio Ø 30 cm (incluida 1 Chapa de cierre para top mod.TPA-7)
cm. 40x 70,5x 90h



⚡ 5 kW _____ **6.102,00**
400V~3 _____ 38 / 0,37
50/60 Hz _____

PCI-78ET **PIANO COTTURA INDUZIONE TRIFASE - N. 4 ZONE - VETRO**
08030833 **CM.75X57 (INCLUSA 1 TESTATA CHIUSURA PIANO MOD. TPA-7)**

EN Three-phase induction cooking - 4 zones - glass cm.75x57 (included 1 Head end filler strip mod.TPA-7) • **DE** Induktions-Kochplatte dreiphasig - 4 zonen - Glas 75x57 cm (inbegriffen 1 Abschluss-Element mod.TPA-7) • **FR** Plan de cuisson à induction triphasé N. 4 zones - Verre cm.75x57 (inclus 1 Élément de jonction top mod.TPA-7) • **ES** Encimera inducción trifásica - 4 zonas - Vidrio cm.75x57 (incluida 1 Chapa de cierre para top mod.TPA-7)
cm. 80x 70,5x 90h



⚡ 20 kW _____ **15.203,00**
400V~3 _____ 70 / 0,71
50/60 Hz _____

PC-74GP **PIANO COTTURA GAS SU MOBILE A GIORNO 2 FUOCHI**
08210450 **(INCLUSA 1 TESTATA CHIUSURA PIANO MOD.TPA-7)**

EN Gas heated boiling unit on open cabinet - 2 burners (included 1 Head end filler strip mod.TPA-7) • **DE** Gas-kochplatte mit offenem Unterbau - 2 Kochstellen (inbegriffen 1 Abschluss-Element mod.TPA-7) • **FR** Rechaud gaz sur armoire ouvert - 2 feux vifs (inclus 1 Élément de jonction top mod.TPA-7) • **ES** Sobres de cocción gas sobre mueble abierto - 2 quemadores (incluida 1 Chapa de cierre para top mod.TPA-7)
cm. 40x 70,5x 90h



⚡ 13 kW _____ **1.727,00**
11.180 kcal/h _____ 63 / 0,37



PIANI COTTURA A GAS

MOD. _____
COD. _____

DESCRIZIONE/DESCRIPTION/BEZEICHNUNG/DESCRIPTION/DESCRIPCIÓN
DIMENSIONI/DIMENSIONS/ABMESSUNGEN/DIMENSIONS/DIMENSIONES

POTENZA/POWER/LEISTUNG/PUISSANCE/POTENCIA
VOLTAGGIO/VOLTAGE/SPANNUNG/VOLTAGE/VOLTAJE

⚡ kW
kcal/h

PREZZO/PRICE
PREIS/PRIX/PRECIO
KG / M³



PC-78GP
08210850

**PIANO COTTURA GAS SU MOBILE A GIORNO 4 FUOCHI
(INCLUSA 1 TESTATA CHIUSURA PIANO MOD.TPA-7)**

EN Gas heated boiling unit on open cabinet - 4 burners (included 1 Head end filler strip mod.TPA-7) • **DE** Gas-Kochplatte mit offenem Unterbau - 4 Kochstellen (inbegriffen 1 Abschluss-Element mod.TPA-7) • **FR** Rechaud gaz sur armoire ouvert - 4 feux vifs (inclus 1 Élément de jonction top mod. TPA-7) • **ES** Sobres de cocción gas sobre mueble abierto - 4 quemadores (incluida 1 Chapa de cierre para top mod.TPA-7)

cm. 80x 70,5x 90h



⚡ 22 kW
18.920 kcal/h

2.762,00
76 / 0,71

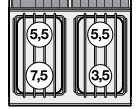

PC-712GP
08211250

**PIANO COTTURA GAS SU MOBILE A GIORNO 6 FUOCHI
(INCLUSA 1 TESTATA CHIUSURA PIANO MOD.TPA-7)**

EN Gas heated boiling unit on open cabinet - 6 burners (included 1 Head end filler strip mod.TPA-7) • **DE** Gas-Kochplatte mit offenem Unterbau - 6 Kochstellen (inbegriffen 1 Abschluss-Element mod.TPA-7) • **FR** Rechaud gaz sur armoire ouvert - 6 feux vifs (inclus 1 Élément de jonction top mod. TPA-7) • **ES** Sobres de cocción gas sobre mueble abierto - 6 quemadores (incluida 1 Chapa de cierre para top mod.TPA-7)

cm. 120x 70,5x 90h



⚡ 35 kW
30.100 kcal/h

3.956,00
126 / 1,05

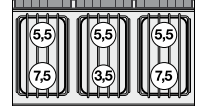

PC1-74G
08210453

**PIANO COTTURA GAS SU MOBILE A GIORNO 1 FUOCHI
(INCLUSA 1 TESTATA CHIUSURA PIANO MOD.TPA-7)**

EN Gas heated boiling unit on open cabinet - 1 burners (included 1 Head end filler strip mod.TPA-7) • **DE** Gas-kochplatte mit offenem Unterbau - 1 Kochstellen (inbegriffen 1 Abschluss-Element mod.TPA-7) • **FR** Rechaud gaz sur armoire ouvert - 1 feux vifs (inclus 1 Élément de jonction top mod. TPA-7) • **ES** Sobres de cocción gas sobre mueble abierto - 1 quemadores (incluida 1 Chapa de cierre para top mod.TPA-7)

cm. 40x 70,5x 90h



⚡ 10 kW
8.600 kcal/h

1.766,00
63 / 0,37

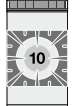

PC2-78G
08210853

**PIANO COTTURA GAS SU MOBILE A GIORNO 2 FUOCHI
(INCLUSA 1 TESTATA CHIUSURA PIANO MOD.TPA-7)**

EN Gas heated boiling unit on open cabinet - 2 burners (included 1 Head end filler strip mod.TPA-7) • **DE** Gas-kochplatte mit offenem Unterbau - 2 Kochstellen (inbegriffen 1 Abschluss-Element mod.TPA-7) • **FR** Rechaud gaz sur armoire ouvert - 2 feux vifs (inclus 1 Élément de jonction top mod. TPA-7) • **ES** Sobres de cocción gas sobre mueble abierto - 2 quemadores (incluida 1 Chapa de cierre para top mod.TPA-7)

cm. 80x 70,5x 90h



⚡ 17 kW
14.620 kcal/h

2.738,00
76 / 0,71

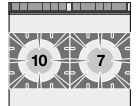

PC3-712G
08211253

**PIANO COTTURA GAS SU MOBILE A GIORNO 3 FUOCHI
(INCLUSA 1 TESTATA CHIUSURA PIANO MOD.TPA-7)**

EN Gas heated boiling unit on open cabinet - 3 burners (included 1 Head end filler strip mod.TPA-7) • **DE** Gas-Kochplatte mit offenem Unterbau - 3 Kochstellen (inbegriffen 1 Abschluss-Element mod.TPA-7) • **FR** Rechaud gaz sur armoire ouvert - 3 feux vifs (inclus 1 Élément de jonction top mod. TPA-7) • **ES** Sobres de cocción gas sobre mueble abierto - 3 quemadores (incluida 1 Chapa de cierre para top mod.TPA-7)

cm. 120x 70,5x 90h



⚡ 27 kW
23.220 kcal/h

3.834,00
126 / 1,05

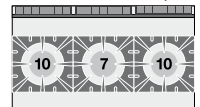

PCA-74GP
08310450

**PIANO COTTURA ACQUA SU MOBILE A GIORNO 2 FUOCHI
- RUBINETTO CARICO ACQUA, SFIORATORE (INCLUSA 1
TESTATA CHIUSURA PIANO MOD.TPA-7)**

EN water heated boiling unit on open cabinet - 2 burners - Water loading tap + overflow device (included 1 Head end filler strip mod.TPA-7) • **DE** wasser-Kochplatte mit offenem Unterbau - 2 Kochstellen - Wasserlauf-Hahn + Überlauf-Vorrichtung (inbegriffen 1 Abschluss-Element mod.TPA-7) • **FR** Rechaud l'eau sur armoire ouvert - 2 feux vifs - Robinet d'arrivée d'eau trop plein (inclus 1 Élément de jonction top mod.TPA-7) • **ES** Sobres de cocción agua sobre mueble abierto 2 quemadores - Grifo carga agua + vertedero (incluida 1 Chapa de cierre para top mod.TPA-7)

cm. 40x 70,5x 90h



⚡ 14 kW
12.040 kcal/h

1.915,00
63 / 0,37



PIANI COTTURA AD ACQUA A GAS

MOD. _____
COD. _____

DESCRIZIONE/DESCRIPTION/BEZEICHNUNG/DESCRIPTION/DESCRIPCIÓN
DIMENSIONI/DIMENSIONS/ABMESSUNGEN/DIMENSIONS/DIMENSIONES

POTENZA/POWER/LEISTUNG/PUISSANCE/POTENCIA
VOLTAGGIO/VOLTAGE/SPANNUNG/VOLTAGE/VOLTAJE

⚡ $\frac{\text{kW}}{\text{kcal/h}}$ $\frac{\text{kW}}{\text{V- Hz}}$

PREZZO/PRICE
PREIS/PRIX/PRECIO
KG / M³



PCA-78GP
08310850

PIANO COTTURA ACQUA SU MOBILE A GIORNO - 4 FUOCHI - RUBINETTO CARICO ACQUA, SFIORATORE (INCLUSA 1 TESTATA CHIUSURA PIANO MOD.TPA-7)

EN water heated boiling unit on open cabinet - 4 burners - Water loading tap + overflow device (included 1 Head end filler strip mod.TPA-7) • **DE** wasser-kochplatte mit offenem Unterbau - 4 Kochstellen - Wasserlauf-Hahn + Überlauf-Vorrichtung (inbegriffen 1 Abschluss-Element mod.TPA-7) • **FR** Rechaud l'eau sur armoire ouvert - 4 feux vifs - Robinet d'arrivée d'eau trop plein (inclus 1 Élément de jonction top mod.TPA-7) • **ES** Sobres de cocción agua sobre mueble abierto 4 quemadores - Grifo carga agua + vertedero (incluida 1 Chapa de cierre para top mod.TPA-7)
cm. 80x 70,5x 90h



⚡ $\frac{28 \text{ kW}}{24.080 \text{ kcal/h}}$ **3.766,00**
76 / 0,71

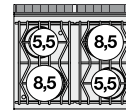

PCA-712GP
08311250

PIANO COTTURA ACQUA SU MOBILE A GIORNO 6 FUOCHI - RUBINETTO CARICO ACQUA, SFIORATORE (INCLUSA 1 TESTATA CHIUSURA PIANO MOD.TPA-7)

EN water heated boiling unit on open cabinet - 6 burners - Water loading tap + overflow device (included 1 Head end filler strip mod.TPA-7) • **DE** wasser-kochplatte mit offenem Unterbau - 6 Kochstellen - Wasserlauf-Hahn + Überlauf-Vorrichtung (inbegriffen 1 Abschluss-Element mod.TPA-7) • **FR** Rechaud l'eau sur armoire ouvert - 6 feux vifs - Robinet d'arrivée d'eau trop plein (inclus 1 Élément de jonction top mod.TPA-7) • **ES** Sobres de cocción agua sobre mueble abierto 6 quemadores - Grifo carga agua + vertedero (incluida 1 Chapa de cierre para top mod.TPA-7)
cm. 120x 70,5x 90h

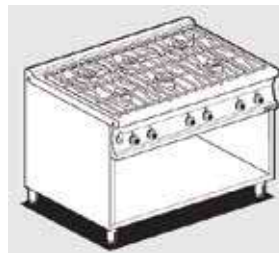

⚡ $\frac{42 \text{ kW}}{36.120 \text{ kcal/h}}$ **5.411,00**
126 / 1,05

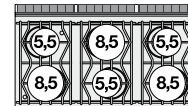

PA-78G
08210851

"PAELLERO" GAS SU MOBILE A GIORNO (INCLUSA 1 TESTATA CHIUSURA PIANO MOD.TPA-7)

EN "PAELLERO" Gas - open cabinet (included 1 Head end filler strip mod.TPA-7) • **DE** "PAELLERO" Gas mit offenem Unterbau (inbegriffen 1 Abschluss-Element mod.TPA-7) • **FR** "PAELLERO" gaz sur armoire ouvert (inclus 1 Élément de jonction top mod.TPA-7) • **ES** "PAELLERO" gas sobre mueble abierto (incluida 1 Chapa de cierre para top mod.TPA-7)
cm. 80x 70,5x 90h



⚡ $\frac{11,5 \text{ kW}}{9.890 \text{ kcal/h}}$ **3.256,00**
111 / 0,71

PAF-78G
082680851

"PAELLERO" GAS SU FORNO GAS STATICO CM. 67X55X34H, TEMP: 150÷300°C, CON 1 GRIGLIA CM.65X53 GN2/1 (INCLUSA 1 TESTATA CHIUSURA PIANO MOD.TPA-7)

EN "PAELLERO" Gas on Traditional gas-oven cm. 67x55x34h, temp: 150÷300°C, with 1 grid cm.65x53 GN2/1 (included 1 Head end filler strip mod.TPA-7) • **DE** "PAELLERO" Gas mit Statischer Gas-Backofen cm. 67x55x34h, temp: 150÷300°C, mit 1 Rost cm.65x53 GN2/1 (inbegriffen 1 Abschluss-Element mod.TPA-7) • **FR** "PAELLERO" gaz sur Four à gaz statique cm. 67x55x34h, temp: 150÷300°C, avec 1 grille cm.65x53 GN2/1 (inclus 1 Élément de jonction top mod.TPA-7) • **ES** "PAELLERO" gas sobre Horno a gas estático cm. 67x55x34h, temp: 150÷300°C, con 1 parrilla cm.65x53 GN2/1 (incluida 1 Chapa de cierre para top mod.TPA-7)
cm. 80x 70,5x 90h



⚡ $\frac{18,8 \text{ kW}}{16.168 \text{ kcal/h}}$ **4.054,00**
159 / 0,71

TP-74G
08290450

TUTTA PIASTRA SU MOBILE A GIORNO PIASTRA CM 37X57 (INCLUSA 1 TESTATA CHIUSURA PIANO MOD.TPA-7)

EN Solid top on open unit - Plate 37x57cm (included 1 Head end filler strip mod.TPA-7) • **DE** Kochplatte auf offenem Unterbau - Platte 37x57 cm (inbegriffen 1 Abschluss-Element mod.TPA-7) • **FR** Toute plaque sur meuble ouvert - Plaque cm 37x57 (inclus 1 Élément de jonction top mod.TPA-7) • **ES** Placa de cocción sobre mueble abierto - Placa cm 37x57 (incluida 1 Chapa de cierre para top mod.TPA-7)
cm. 40x 70,5x 90h



⚡ $\frac{7 \text{ kW}}{6.020 \text{ kcal/h}}$ **2.140,00**
65 / 0,37

TUTTAPIASTRA A GAS

MOD. _____
COD. _____

DESCRIZIONE/DESCRIPTION/BEZEICHNUNG/DESCRIPTION/DESCRIPCIÓN
DIMENSIONI/DIMENSIONS/ABMESSUNGEN/DIMENSIONS/DIMENSIONES

POTENZA/POWER/LEISTUNG/PUISSANCE/POTENCIA
VOLTAGGIO/VOLTAGE/SPANNUNG/VOLTAGE/VOLTAJE

⚡ kW
kcal/h

⚡ kw
V~
Hz

PREZZO/PRICE
PREIS/PRIX/PRECIO
KG / M³



TP-78G
08290850

TUTTA PIASTRA SU MOBILE A GIORNO PIASTRA CM 77X57 (INCLUSA 1 TESTATA CHIUSURA PIANO MOD.TPA-7)

EN Solid top on open unit - Plate 77x57cm (included 1 Head end filler strip mod.TPA-7) • **DE** Kochplatte auf offenem Unterbau - Platte 77x57 cm (inbegriffen 1 Abschluss-Element mod.TPA-7) • **FR** Toute plaque sur meuble ouvert - Plaque cm 77x57 (inclus 1 Élément de jonction top mod.TPA-7) • **ES** Placa de cocción sobre mueble abierto - Placa cm 77x57 (incluida 1 Chapa de cierre para top mod.TPA-7)
cm. 80x 70,5x 90h



⚡ 12 kW
10.320 kcal/h

2.911,00
121 / 0,71

TP2-78GP
08300850

TUTTA PIASTRA + 2 FUOCHI SU MOBILE A GIORNO PIASTRA CM. 37X57 (INCLUSA 1 TESTATA CHIUSURA PIANO MOD. TPA-7)

EN Solid top + 2 burners on open unit Plate 37x57 (included 1 Head end filler strip mod.TPA-7) • **DE** Kochplatte + 2 Gaskochstellen auf offenem Unterbau Platte 37x57 (inbegriffen 1 Abschluss-Element mod.TPA-7) • **FR** Toute plaque + 2 brûleurs sur meuble ouvert Plaque cm. 37x57 (inclus 1 Élément de jonction top mod.TPA-7) • **ES** Placa de cocción + 2 fuegos sobre mueble abierto Placa cm. 37x57 (incluida 1 Chapa de cierre para top mod.TPA-7)
cm. 80x 70,5x 90h



⚡ 20 kW
17.200 kcal/h

3.355,00
115 / 0,71

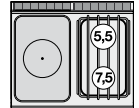

TP2-712GP
08291250

TUTTA PIASTRA + 2 FUOCHI SU MOBILE A GIORNO PIASTRA CM. 77X57 (INCLUSA 1 TESTATA CHIUSURA PIANO MOD. TPA-7)

EN Solid top + 2 burners on open unit Plate 77x57 (included 1 Head end filler strip mod.TPA-7) • **DE** Kochplatte + 2 Gaskochstellen auf offenem Unterbau Platte 77x57 (inbegriffen 1 Abschluss-Element mod.TPA-7) • **FR** Toute plaque + 2 brûleurs sur meuble ouvert Plaque cm. 77x57 (inclus 1 Élément de jonction top mod.TPA-7) • **ES** Placa de cocción + 2 fuegos sobre mueble abierto Placa cm. 77x57 (incluida 1 Chapa de cierre para top mod.TPA-7)
cm. 120x 70,5x 90h

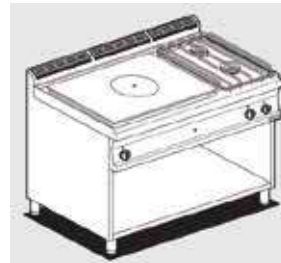

⚡ 25 kW
21.500 kcal/h

4.333,00
157 / 1,05

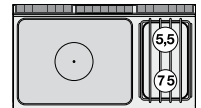

TP4-712GP
08301250

TUTTA PIASTRA + 4 FUOCHI SU MOBILE A GIORNO PIASTRA CM. 37X57 (INCLUSA 1 TESTATA CHIUSURA PIANO MOD. TPA-7)

EN Solid top + 4 burners on open unit Plate 37x57 cm (included 1 Head end filler strip mod.TPA-7) • **DE** Kochplatte + 4 Gaskochstellen auf offenem Unterbau Platte 37x57 cm (inbegriffen 1 Abschluss-Element mod.TPA-7) • **FR** Toute plaque + 4 brûleurs sur meuble ouvert Plaque cm. 37x57 (inclus 1 Élément de jonction top mod.TPA-7) • **ES** Placa de cocción + 4 fuegos sobre mueble abierto Placa cm. 37x57 (incluida 1 Chapa de cierre para top mod.TPA-7)
cm. 120x 70,5x 90h



⚡ 29 kW
24.940 kcal/h

4.458,00
154 / 1,05

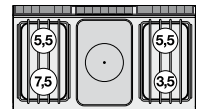

TP-78ET
08120830

TUTTA PIASTRA SU MOBILE A GIORNO PIASTRA CM. 70X50 - 4 ZONE (INCLUSA 1 TESTATA CHIUSURA PIANO MOD.TPA-7)

EN Solid top on open unit - Plate cm. 70x50 - 4 zones (included 1 Head end filler strip mod.TPA-7) • **DE** Kochplatten auf offenem Unterbau - Platte cm. 70x50 - 4 zonen (inbegriffen 1 Abschluss-Element mod.TPA-7) • **FR** Toute plaque sur meuble ouvert - Plaque cm. 70x50 - 4 zones (inclus 1 Élément de jonction top mod.TPA-7) • **ES** Placa de cocción sobre mueble abierto - Placa cm. 70x50 - 4 zonas (incluida 1 Chapa de cierre para top mod.TPA-7)
cm. 80x 70,5x 90h



⚡ 10 kW
400V~3N
50/60 Hz

3.586,00
121 / 0,71

TUTTAPIASTRA ELETTRICO CON FORNO

MOD. _____
COD. _____

DESCRIZIONE/DESCRIPTION/BEZEICHNUNG/DESCRIPTION/DESCRIPCIÓN
DIMENSIONI/DIMENSIONS/ABMESSUNGEN/DIMENSIONS/DIMENSIONES

POTENZA/POWER/LEISTUNG/PUISSANCE/POTENCIA
VOLTAGGIO/VOLTAGE/SPANNUNG/VOLTAGE/VOLTAJE

⚡ kW
kcal/h

PREZZO/PRICE
PREIS/PRIX/PRECIO
KG / M³



TPF-78ET
08670830

TUTTA PIASTRA SU FORNO ELETTRICO STATICO CM. 67X55X34H, TEMP: 50÷300°C , CON 1 GRIGLIA CM.65X53 GN2/1 - PIASTRA CM. 70X50 4 ZONE (INCLUSA 1 TESTATA CHIUSURA PIANO MOD.TPA-7)

EN Solid top on traditional electric oven cm. 67x55x34h, temp: 50÷300°C , with 1 grid cm.65x53 GN2/1 - Plate cm. 70x50 4 zones (included 1 Head end filler strip mod.TPA-7) • **DE** Kochplatten - Statischer Elektro-Backofen cm. 67x55x34h, temp: 50÷300°C , mit 1 Rost cm.65x53 GN2/1 - Platte cm. 70x50 4 zonen (inbegriffen 1 Abschluss-Element mod.TPA-7) • **FR** Toute plaque sur Four électrique statique cm. 67x55x34h, temp: 50÷300°C , avec 1 grille cm.65x53 GN2/1 - Plaque cm. 70x50 4 zones (inclus 1 Élément de jonction top mod.TPA-7) • **ES** Placa de cocción sobre Horno eléctrico estático cm. 67x55x34h, temp: 50÷300°C , con 1 parilla cm.65x53 GN2/1 - Placa cm. 70x50 4 zonas (incluida 1 Chapa de cierre para top mod.TPA-7)
cm. 80x 70,5x 90h



⚡ 15 kW
400V~3N
50/60 Hz

5.041,00
170 / 0,71

TPFV-78ET
08670835

TUTTA PIASTRA SU FORNO ELETTRICO VENTILATO CM. 55X36X34H, TEMP: 50÷300°C , CON 1 GRIGLIA CM.53X32,5 GN1/1 - PIASTRA CM. 70X50 4 ZONE (INCLUSA 1 TESTATA CHIUSURA PIANO MOD.TPA-7)

EN Solid top on electric fan oven cm. 55x36x34h, temp: 50÷300°C , with 1 grid cm.53x32,5 GN1/1 - Plate cm. 70x50 4 zones (included 1 Head end filler strip mod.TPA-7) • **DE** Kochplatten - Elektro-Heißluftofen cm. 55x36x34h, temp: 50÷300°C , mit 1 Rost cm.53x32,5 GN1/1 - Platte cm. 70x50 4 Zonen (inbegriffen 1 Abschluss-Element mod.TPA-7) • **FR** Toute plaque sur Four à chaleur tournante électrique cm. 55x36x34h, temp: 50÷300°C , avec 1 grille cm.53x32,5 GN1/1 - Plaque cm. 70x50 4 zones (inclus 1 Élément de jonction top mod.TPA-7) • **ES** Placa de cocción sobre Horno eléctrico ventilado cm. 55x36x34h, temp: 50÷300°C , con 1 parilla cm.53x32,5 GN1/1 - Placa cm. 70x50 4 zonas (incluida 1 Chapa de cierre para top mod.TPA-7)
cm. 80x 70,5x 90h

⚡ 15,32 kW
400V~3N
50/60 Hz

5.431,00
170 / 0,71

TPF-78G
08700850

TUTTA PIASTRA SU FORNO GAS STATICO CM. 67X55X34H, TEMP: 150÷300°C, CON 1 GRIGLIA CM.65X53 GN2/1 - PIASTRA CM 77X57 (INCLUSA 1 TESTATA CHIUSURA PIANO MOD.TPA-7)

EN Solid top on Traditional gas-oven cm. 67x55x34h, temp: 150÷300°C, with 1 grid cm.65x53 GN2/1 - Plate cm. 77x57 (included 1 Head end filler strip mod.TPA-7) • **DE** Kochplatten - Statischer Gas-Backofen cm. 67x55x34h, temp: 150÷300°C, mit 1 Rost cm.65x53 GN2/1 - Platte cm. 77x57 (inbegriffen 1 Abschluss-Element mod.TPA-7) • **FR** Toute plaque sur Four à gaz statique cm. 67x55x34h, temp: 150÷300°C, avec 1 grille cm.65x53 GN2/1 - Plaque cm. 77x57 (inclus 1 Élément de jonction top mod.TPA-7) • **ES** Placa de cocción sobre Horno a gas estático cm. 67x55x34h, temp: 150÷300°C, con 1 parilla cm.65x53 GN2/1 - Placa cm. 77x57 (incluida 1 Chapa de cierre para top mod.TPA-7)
cm. 80x 70,5x 90h



⚡ 19,3 kW
16.600 kcal/h

4.573,00
169 / 0,71

TPF-78GE
08710860

TUTTA PIASTRA SU FORNO ELETTRICO STATICO CM. 67X55X34H, TEMP: 50÷300°C , CON 1 GRIGLIA CM.65X53 GN2/1 - PIASTRA CM. 77X57 (INCLUSA 1 TESTATA CHIUSURA PIANO MOD.TPA-7)

EN Solid top on traditional electric oven cm. 67x55x34h, temp: 50÷300°C , with 1 grid cm.65x53 GN2/1 - Plate cm. 77x57 (included 1 Head end filler strip mod.TPA-7) • **DE** Kochplatten - Statischer Elektro-Backofen cm. 67x55x34h, temp: 50÷300°C , mit 1 Rost cm.65x53 GN2/1 - Platte cm. 77x57 (inbegriffen 1 Abschluss-Element mod.TPA-7) • **FR** Toute plaque sur Four électrique statique cm. 67x55x34h, temp: 50÷300°C , avec 1 grille cm.65x53 GN2/1 - Plaque cm. 77x57 (inclus 1 Élément de jonction top mod.TPA-7) • **ES** Placa de cocción sobre Horno eléctrico estático cm. 67x55x34h, temp: 50÷300°C , con 1 parilla cm.65x53 GN2/1 - Placa cm. 77x57 (incluida 1 Chapa de cierre para top mod.TPA-7)
cm. 80x 70,5x 90h



⚡ 12 kW
10.320 kcal/h

4.532,00
170 / 0,71

⚡ 5 kW
400V~3N
50/60 Hz

TUTTAPIASTRA A GAS CON FORNO ELETTRICO

MOD. _____
COD. _____

DESCRIZIONE/DESCRIPTION/BEZEICHNUNG/DESCRIPTION/DESCRIPCIÓN
DIMENSIONI/DIMENSIONS/ABMESSUNGEN/DIMENSIONS/DIMENSIONES

POTENZA/POWER/LEISTUNG/PUISSANCE/POTENCIA
VOLTAGGIO/VOLTAGE/SPANNUNG/VOLTAGE/VOLTAJE

⚡ kW
kcal/h

⚡ kW
V~
Hz

PREZZO/PRICE
PREIS/PRIX/PRECIO
KG / M³



TPFV-78GE
08710865

TUTTA PIASTRA SU FORNO ELETTRICO VENTILATO CM. 55X36X34H, TEMP: 50÷300°C, CON 1 GRIGLIA CM.53X32,5 GN1/1 - PIASTRA CM. 77X57 (INCLUSA 1 TESTATA CHIUSURA PIANO MOD.TPA-7)

EN Solid top on electric fan oven cm. 55x36x34h, temp: 50÷300°C, with 1 grid cm.53x32,5 GN1/1 - Plate cm. 77x57 (included 1 Head end filler strip mod.TPA-7) • **DE** Kochplatten - Elektro-Heißluftofen cm. 55x36x34h, temp: 50÷300°C, mit 1 Rost cm.53x32,5 GN1/1 - Platte cm. 77x57 (inbegriffen 1 Abschluss-Element mod.TPA-7) • **FR** Toute plaque sur Four à chaleur tournante électrique cm. 55x36x34h, temp: 50÷300°C, avec 1 grille cm.53x32,5 GN1/1 - Plaque cm. 77x57 (inclus 1 Élément de jonction top mod.TPA-7) • **ES** Placa de cocción sobre Horno eléctrico ventilado cm. 55x36x34h, temp: 50÷300°C, con 1 parilla cm.53x32,5 GN1/1 - Placa cm. 77x57 (incluida 1 Chapa de cierre para top mod.TPA-7)

cm. 80x 70,5x 90h



⚡ 12 kW
10.320 kcal/h

4.944,00
170 / 0,71

⚡ 5,32 kW
400V~3N
230V~3
50/60 Hz

TPF2-78GP
08720850

TUTTA PIASTRA + 2 FUOCHI SU FORNO GAS STATICO CM. 67X55X34H, TEMP: 150÷300°C, CON 1 GRIGLIA CM.65X53 GN2/1 - PIASTRA CM 37X57 (INCLUSA 1 TESTATA CHIUSURA PIANO MOD.TPA-7)

EN Solid top + 2 burners Traditional gas-oven cm. 67x55x34h, temp: 150÷300°C, with 1 grid cm.65x53 GN2/1 - Plate 37x57cm (included 1 Head end filler strip mod.TPA-7) • **DE** Kochplatte + 2 Gaskochstellen auf Statischer Gas-Backofen cm. 67x55x34h, temp: 150÷300°C, mit 1 Rost cm.65x53 GN2/1 - Platte 37x57 cm (inbegriffen 1 Abschluss-Element mod.TPA-7) • **FR** Toute plaque + 2 brûleurs sur Four à gaz statique cm. 67x55x34h, temp: 150÷300°C, avec 1 grille cm.65x53 GN2/1 - Plaque cm. 37x57 (inclus 1 Élément de jonction top mod.TPA-7) • **ES** Placa de cocción + 2 fuegos sobre Horno a gas estático cm. 67x55x34h, temp: 150÷300°C, con 1 parilla cm.65x53 GN2/1 - Placa cm 37x57 (incluida 1 Chapa de cierre para top mod.TPA-7)

cm. 80x 70,5x 90h



⚡ 27,3 kW
23.478 kcal/h

4.911,00
165 / 0,71

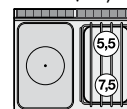

TPF2-78GPE
08730860

TUTTA PIASTRA + 2 FUOCHI SU FORNO ELETTRICO STATICO CM. 67X55X34H, TEMP: 50÷300°C, CON 1 GRIGLIA CM.65X53 GN2/1 - PIASTRA CM 37X57 (INCLUSA 1 TESTATA CHIUSURA PIANO MOD.TPA-7)

EN Solid top + 2 burners traditional electric oven cm. 67x55x34h, temp: 50÷300°C, with 1 grid cm.65x53 GN2/1 - Plate 37x57cm (included 1 Head end filler strip mod.TPA-7) • **DE** Kochplatte + 2 Gaskochstellen auf Statischer Elektro-Backofen cm. 67x55x34h, temp: 50÷300°C, mit 1 Rost cm.65x53 GN2/1 - Platte 37x57 cm (inbegriffen 1 Abschluss-Element mod.TPA-7) • **FR** Toute plaque + 2 brûleurs sur Four électrique statique cm. 67x55x34h, temp: 50÷300°C, avec 1 grille cm.65x53 GN2/1 - Plaque cm. 37x57 (inclus 1 Élément de jonction top mod.TPA-7) • **ES** Placa de cocción + 2 fuegos sobre Horno eléctrico estático cm. 67x55x34h, temp: 50÷300°C, con 1 parilla cm.65x53 GN2/1 - Placa cm 37x57 (incluida 1 Chapa de cierre para top mod.TPA-7)

cm. 80x 70,5x 90h



⚡ 20 kW
17.200 kcal/h

4.868,00
166 / 0,71

⚡ 5 kW
400V~3N
50/60 Hz

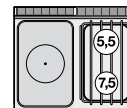

TPFV2-78GPE
08730865

TUTTA PIASTRA + 2 FUOCHI SU FORNO ELETTRICO VENTILATO CM. 55X36X34H, TEMP: 50÷300°C, CON 1 GRIGLIA CM.53X32,5 GN1/1 - PIASTRA CM 37X57 (INCLUSA 1 TESTATA CHIUSURA PIANO MOD.TPA-7)

EN Solid top + 2 burners electric fan oven cm. 55x36x34h, temp: 50÷300°C, with 1 grid cm.53x32,5 GN1/1 - Plate 37x57cm (included 1 Head end filler strip mod.TPA-7) • **DE** Kochplatte + 2 Gaskochstellen auf Elektro-Heißluftofen cm. 55x36x34h, temp: 50÷300°C, mit 1 Rost cm.53x32,5 GN1/1 - Platte 37x57 cm (inbegriffen 1 Abschluss-Element mod.TPA-7) • **FR** Toute plaque + 2 brûleurs sur Four à chaleur tournante électrique cm. 55x36x34h, temp: 50÷300°C, avec 1 grille cm.53x32,5 GN1/1 - Plaque cm. 37x57 (inclus 1 Élément de jonction top mod.TPA-7) • **ES** Placa de cocción + 2 fuegos sobre Horno eléctrico ventilado cm. 55x36x34h, temp: 50÷300°C, con 1 parilla cm.53x32,5 GN1/1 - Placa cm 37x57 (incluida 1 Chapa de cierre para top mod.TPA-7)

cm. 80x 70,5x 90h

⚡ 20 kW
17.200 kcal/h

5.267,00
166 / 0,71

⚡ 5,32 kW
400V~3N
230V~3
50/60 Hz

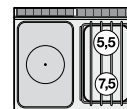

TUTTAPIASTRA A GAS CON FORNO

MOD. _____
COD. _____

DESCRIZIONE/DESCRIPTION/BEZEICHNUNG/DESCRIPTION/DESCRIPCIÓN
DIMENSIONI/DIMENSIONS/ABMESSUNGEN/DIMENSIONS/DIMENSIONES

POTENZA/POWER/LEISTUNG/PUISSANCE/POTENCIA
VOLTAGGIO/VOLTAGE/SPANNUNG/VOLTAGE/VOLTAJE

⚡ kW _____
kcal/h _____

PREZZO/PRICE
PREIS/PRIX/PRECIO
KG / M³



TPF2-712GPV TUTTA PIASTRA + 2 FUOCHI SU FORNO GAS STATICO CM. 67X55X34H, TEMP: 150÷300°C, CON 1 GRIGLIA CM.65X53 GN2/1 - PIASTRA CM 77X57 - VANO NEUTRO CON PORTA (INCLUSA 1 TESTATA CHIUSURA PIANO MOD.TPA-7)

08701251

EN Solid top + 2 burners Traditional gas-oven cm. 67x55x34h, temp: 150÷300°C, with 1 grid cm.65x53 GN2/1 - Plate 77x57cm - Neutral cabinet with door (included 1 Head end filler strip mod.TPA-7) • **DE** Kochplatte + 2 Gaskochstellen auf Statischer Gas-Backofen cm. 67x55x34h, temp: 150÷300°C, mit 1 Rost cm.65x53 GN2/1 - Platte 77x57 cm - Neutrales Schrankelement mit Tür (inbegriffen 1 Abschluss-Element mod.TPA-7) • **FR** Toute plaque + 2 brûleurs sur Four à gaz statique cm. 67x55x34h, temp: 150÷300°C, avec 1 grille cm.65x53 GN2/1 - Plaque cm. 77x57 - Element neutre avec porte (inclus 1 Élément de jonction top mod.TPA-7) • **ES** Placa de cocción + 2 fuegos sobre Horno a gas estático cm. 67x55x34h, temp: 150÷300°C, con 1 parilla cm.65x53 GN2/1 - Placa cm 77x57 - Armario neutro con puerta (incluida 1 Chapa de cierre para top mod.TPA-7)
cm. 120x 70,5x 90h



⚡ 32,3 kW _____
27.778 kcal/h _____ **6.296,00**
227 / 1,05

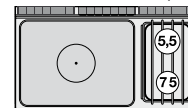

TPF2-712GPEV TUTTA PIASTRA + 2 FUOCHI SU FORNO ELETTRICO STATICO CM. 67X55X34H, TEMP: 50÷300°C, CON 1 GRIGLIA CM.65X53 GN2/1 - PIASTRA CM 77X57 - VANO NEUTRO CON PORTA (INCLUSA 1 TESTATA CHIUSURA PIANO MOD. TPA-7)

08711261

EN Solid top + 2 burners traditional electric oven cm. 67x55x34h, temp: 50÷300°C, with 1 grid cm.65x53 GN2/1 - Plate 77x57cm - Neutral cabinet with door (included 1 Head end filler strip mod.TPA-7) • **DE** Kochplatte + 2 Gaskochstellen auf Statischer Elektro-Backofen cm. 67x55x34h, temp: 50÷300°C, mit 1 Rost cm.65x53 GN2/1 - Platte 77x57 cm - Neutrales Schrankelement mit Tür (inbegriffen 1 Abschluss-Element mod.TPA-7) • **FR** Toute plaque + 2 brûleurs sur Four électrique statique cm. 67x55x34h, temp: 50÷300°C, avec 1 grille cm.65x53 GN2/1 - Plaque cm. 77x57 - Element neutre avec porte (inclus 1 Élément de jonction top mod.TPA-7) • **ES** Placa de cocción + 2 fuegos sobre Horno eléctrico estático cm. 67x55x34h, temp: 50÷300°C, con 1 parilla cm.65x53 GN2/1 - Placa cm 77x57 - Armario neutro con puerta (incluida 1 Chapa de cierre para top mod.TPA-7)
cm. 120x 70,5x 90h



⚡ 25 kW _____
21.500 kcal/h _____ **6.239,00**
227 / 1,05

⚡ 5 kW _____
400V~3N
50/60 Hz

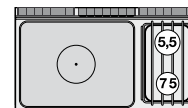

TPFV2-712GPEV TUTTA PIASTRA + 2 FUOCHI SU FORNO ELETTRICO VENTILATO CM. 55X36X34H, TEMP: 50÷300°C, CON 1 GRIGLIA CM.53X32,5 GN1/1 - PIASTRA CM 77X57 - VANO NEUTRO CON PORTA (INCLUSA 1 TESTATA CHIUSURA PIANO MOD.TPA-7)

08711266

EN Solid top + 2 burners electric fan oven cm. 55x36x34h, temp: 50÷300°C, with 1 grid cm.53x32,5 GN1/1 - Plate 77x57cm - Neutral cabinet with door (included 1 Head end filler strip mod.TPA-7) • **DE** Kochplatte + 2 Gaskochstellen auf Elektro-Heißluftofen cm. 55x36x34h, temp: 50÷300°C, mit 1 Rost cm.53x32,5 GN1/1 - Platte 77x57 cm - Neutrales Schrankelement mit Tür (inbegriffen 1 Abschluss-Element mod.TPA-7) • **FR** Toute plaque + 2 brûleurs sur Four à chaleur tournante électrique cm. 55x36x34h, temp: 50÷300°C, avec 1 grille cm.53x32,5 GN1/1 Plaque cm. 77x57 - Element neutre avec porte (inclus 1 Élément de jonction top mod.TPA-7) • **ES** Placa de cocción + 2 fuegos sobre Horno eléctrico ventilado cm. 55x36x34h, temp: 50÷300°C, con 1 parilla cm.53x32,5 GN1/1 - Placa cm 77x57 - Armario neutro con puerta (incluida 1 Chapa de cierre para top mod.TPA-7)
cm. 120x 70,5x 90h

⚡ 25 kW _____
21.500 kcal/h _____ **6.650,00**
227 / 1,05

⚡ 5,32 kW _____
400V~3N
230V~3
50/60 Hz

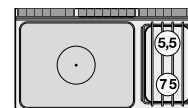

TUTTAPIASTRA A GAS CON FORNO

MOD. _____
COD. _____

DESCRIZIONE/DESCRIPTION/BEZEICHNUNG/DESCRIPTION/DESCRIPCIÓN
DIMENSIONI/DIMENSIONS/ABMESSUNGEN/DIMENSIONS/DIMENSIONES

POTENZA/POWER/LEISTUNG/PUISSANCE/POTENCIA
VOLTAGGIO/VOLTAGE/SPANNUNG/VOLTAGE/VOLTAJE

⚡ kW _____
kcal/h _____
V~ _____
Hz _____

PREZZO/PRICE
PREIS/PRIX/PRECIO
KG / M³



TPF2-712GP TUTTA PIASTRA + 2 FUOCHI SU FORNO GAS STATICO
08701250 **CM. 107X55X34H, TEMP: 150÷300°C, CON 1 GRIGLIA**
CM.105X53 - PIASTRA CM 77X57 (INCLUSA 1 TESTATA
CHIUSURA PIANO MOD.TPA-7)

EN Solid top + 2 burners Traditional gas-oven cm. 107x55x34h, temp: 150÷300°C, with 1 grid cm.105x53 - Plate 77x57 (included 1 Head end filler strip mod.TPA-7) • **DE** Kochplatte + 2 Gaskochstellen auf Statischer Gas-Backofen cm. 107x55x34h, temp: 150÷300°C, mit 1 Rost cm.105x53 - Platte 77x57 (inbegriffen 1 Abschluss-Element mod.TPA-7) • **FR** Toute plaque + 2 brûleurs sur Four à gaz statique cm. 107x55x34h, temp: 150÷300°C, avec 1 grille cm.105x53 - Plaque cm. 77x57 (inclus 1 Élément de jonction top mod.TPA-7) • **ES** Placa de cocción + 2 fuegos sobre Horno a gas estático cm. 107x55x34h, temp: 150÷300°C, con 1 parilla cm.105x53 - Placa cm 77x57 (incluida 1 Chapa de cierre para top mod.TPA-7)
cm. 120x 70,5x 90h



⚡ 36 kW _____ **6.750,00**
30.960 kcal/h 209 / 1,05

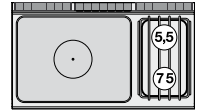

TPF2-712GPE TUTTA PIASTRA + 2 FUOCHI SU FORNO ELETTRICO STATICO
08711260 **CM. 107X55X34H, TEMP: 50÷300°C , CON 1 GRIGLIA**
CM.105X53 - PIASTRA CM 77X57 (INCLUSA 1 TESTATA
CHIUSURA PIANO MOD.TPA-7)

EN Solid top + 2 burners traditional electric oven cm. 107x55x34h, temp: 50÷300°C , with 1 grid cm.105x53 - Plate 77x57 (included 1 Head end filler strip mod.TPA-7) • **DE** Kochplatte + 2 Gaskochstellen auf Statischer Elektro-Backofen cm. 107x55x34h, temp: 50÷300°C , mit 1 Rost cm.105x53 - Platte 77x57 (inbegriffen 1 Abschluss-Element mod.TPA-7) • **FR** Toute plaque + 2 brûleurs sur Four électrique statique cm. 107x55x34h, temp: 50÷300°C , avec 1 grille cm.105x53 - Plaque cm. 77x57 (inclus 1 Élément de jonction top mod.TPA-7) • **ES** Placa de cocción + 2 fuegos sobre Horno eléctrico estático cm. 107x55x34h, temp: 50÷300°C , con 1 parilla cm.105x53 - Placa cm 77x57 (incluida 1 Chapa de cierre para top mod.TPA-7)
cm. 120x 70,5x 90h



⚡ 25 kW _____ **6.690,00**
21.500 kcal/h 209 / 1,05

⚡ 6,9 kW _____
400V~3N
50/60 Hz

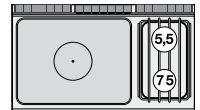

TPF4-712GPV TUTTA PIASTRA + 4 FUOCHI SU FORNO GAS STATICO CM.
08721251 **67X55X34H, TEMP: 150÷300°C, CON 1 GRIGLIA CM.65X53**
GN2/1 - PIASTRA CM 37X57 - VANO NEUTRO CON PORTA
(INCLUSA 1 TESTATA CHIUSURA PIANO MOD.TPA-7)

EN Solid top + 4 burners Traditional gas-oven cm. 67x55x34h, temp: 150÷300°C, with 1 grid cm.65x53 GN2/1 - Plate 37x57cm - Neutral cabinet with door (included 1 Head end filler strip mod.TPA-7) • **DE** Kochplatte + 4 Gaskochstellen auf Statischer Gas-Backofen cm. 67x55x34h, temp: 150÷300°C, mit 1 Rost cm.65x53 GN2/1 - Platte 37x57 cm - Neutrales Schrankelement mit Tür (inbegriffen 1 Abschluss-Element mod.TPA-7) • **FR** Toute plaque + 4 brûleurs sur Four à gaz statique cm. 67x55x34h, temp: 150÷300°C, avec 1 grille cm.65x53 GN2/1 - Plaque cm. 37x57 - Element neutre avec porte (inclus 1 Élément de jonction top mod.TPA-7) • **ES** Placa de cocción + 4 fuegos sobre Horno a gas estático cm. 67x55x34h, temp: 150÷300°C, con 1 parilla cm.65x53 GN2/1 - Placa cm 37x57 - Armario neutro con puerta (incluida 1 Chapa de cierre para top mod.TPA-7)
cm. 120x 70,5x 90h



⚡ 36,3 kW _____ **6.293,00**
31.218 kcal/h 221 / 1,05

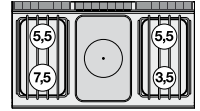

TPF4-712GPEV TUTTA PIASTRA + 4 FUOCHI SU FORNO ELETTRICO STATICO
08731261 **CM. 67X55X34H, TEMP: 50÷300°C , CON 1 GRIGLIA**
CM.65X53 GN2/1 - PIASTRA CM 37X57 - VANO NEUTRO
CON PORTA (INCLUSA 1 TESTATA CHIUSURA PIANO MOD.
TPA-7)

EN Solid top + 4 burners traditional electric oven cm. 67x55x34h, temp: 50÷300°C , with 1 grid cm.65x53 GN2/1 - Plate 37x57cm - Neutral cabinet with door (included 1 Head end filler strip mod.TPA-7) • **DE** Kochplatte + 4 Gaskochstellen auf Statischer Elektro-Backofen cm. 67x55x34h, temp: 50÷300°C , mit 1 Rost cm.65x53 GN2/1 - Platte 37x57 cm - Neutrales Schrankelement mit Tür (inbegriffen 1 Abschluss-Element mod.TPA-7) • **FR** Toute plaque + 4 brûleurs sur Four électrique statique cm. 67x55x34h, temp: 50÷300°C , avec 1 grille cm.65x53 GN2/1 - Plaque cm. 37x57 - Element neutre avec porte (inclus 1 Élément de jonction top mod.TPA-7) • **ES** Placa de cocción + 4 fuegos sobre Horno eléctrico estático cm. 67x55x34h, temp: 50÷300°C , con 1 parilla cm.65x53 GN2/1 - Placa cm 37x57 - Armario neutro con puerta (incluida 1 Chapa de cierre para top mod.TPA-7)
cm. 120x 70,5x 90h



⚡ 29 kW _____ **6.237,00**
24.940 kcal/h 221 / 1,05

⚡ 5 kW _____
400V~3N
50/60 Hz

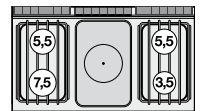

TUTTAPIASTRA A GAS CON FORNO ELETTRICO

MOD. _____
COD. _____

DESCRIZIONE/DESCRIPTION/BEZEICHNUNG/DESCRIPTION/DESCRIPCIÓN
DIMENSIONI/DIMENSIONS/ABMESSUNGEN/DIMENSIONS/DIMENSIONES

POTENZA/POWER/LEISTUNG/PUISSANCE/POTENCIA
VOLTAGGIO/VOLTAGE/SPANNUNG/VOLTAGE/VOLTAJE

⚡ kW _____
kcal/h _____
⚡ kw _____
V~ _____
Hz _____

PREZZO/PRICE
PREIS/PRIX/PRECIO
KG / M³



TPFV4-712GPEV
08731266

TUTTA PIASTRA + 4 FUOCHI SU FORNO ELETTRICO VENTILATO CM. 55X36X34H, TEMP: 50÷300°C , CON 1 GRIGLIA CM.53X32,5 GN1/1 - PIASTRA CM 37X57 - VANO NEUTRO CON PORTA (INCLUSA 1 TESTATA CHIUSURA PIANO MOD.TPA-7)

EN Solid top + 4 burners electric fan oven cm. 55x36x34h, temp: 50÷300°C , with 1 grid cm.53x32,5 GN1/1 - Plate 37x57cm - Neutral cabinet with door (included 1 Head end filler strip mod.TPA-7) • **DE** Kochplatte + 4 Gaskochstellen auf Elektro-Heißluftofen cm. 55x36x34h, temp: 50÷300°C , mit 1 Rost cm.53x32,5 GN1/1 - Platte 37x57 cm - Neutrales Schrankelement mit Tür (inbegriffen 1 Abschluss-Element mod. TPA-7) • **FR** Toute plaque + 4 brûleurs sur Four à chaleur tournante électrique cm. 55x36x34h, temp: 50÷300°C , avec 1 grille cm.53x32,5 GN1/1 - Plaque cm. 37x57 - Element neutre avec porte (inclus 1 Élément de jonction top mod.TPA-7) • **ES** Placa de cocción + 4 fuegos sobre Horno eléctrico ventilado cm. 55x36x34h, temp: 50÷300°C , con 1 parilla cm.53x32,5 GN1/1 - Placa cm 37x57 - Armario neutro con puerta (incluida 1 Chapa de cierre para top mod.TPA-7)
cm. 120x 70,5x 90h



⚡ 29 kW _____ **6.638,00**
24.940 kcal/h 221 / 1,05

⚡ 5,32 kW _____
400V~3N
230V~3
50/60 Hz

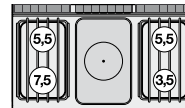

TPF4-712GP
08721250

TUTTA PIASTRA + 4 FUOCHI SU FORNO GAS STATICO CM. 107X55X34H, TEMP: 150-300°C, CON 1 GRIGLIA CM.105X53 - PIASTRA CM 37X57 (INCLUSA 1 TESTATA CHIUSURA PIANO MOD.TPA-7)

EN Solid top + 4 burners Traditional gas-oven cm. 107x55x34h, temp: 150÷300°C, with 1 grid cm.105x53 - Plate 37x57cm (included 1 Head end filler strip mod.TPA-7) • **DE** Kochplatte + 4 Gaskochstellen auf Statischer Gas-Backofen cm. 107x55x34h, temp: 150÷300°C, mit 1 Rost cm.105x53 - Platte 37x57 cm (inbegriffen 1 Abschluss-Element mod.TPA-7) • **FR** Toute plaque + 4 brûleurs sur Four à gaz statique cm. 107x55x34h, temp: 150÷300°C, avec 1 grille cm.105x53 Plaque cm. 37x57 (inclus 1 Élément de jonction top mod.TPA-7) • **ES** Placa de cocción + 4 fuegos sobre Horno a gas estático cm. 107x55x34h, temp: 150÷300°C, con 1 parilla cm.105x53 - Placa cm 37x57 (incluida 1 Chapa de cierre para top mod.TPA-7)
cm. 120x 70,5x 90h



⚡ 40 kW _____ **7.060,00**
34.400 kcal/h 202 / 1,05

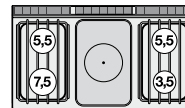

TPF4-712GPE
08731260

TUTTA PIASTRA + 4 FUOCHI SU FORNO ELETTRICO STATICO CM. 107X55X34H, TEMP: 50÷300°C , CON 1 GRIGLIA CM.105X53 - PIASTRA CM 37X57 (INCLUSA 1 TESTATA CHIUSURA PIANO MOD.TPA-7)

EN Solid top + 4 burners traditional electric oven cm. 107x55x34h, temp: 50÷300°C , with 1 grid cm.105x53 - Plate 37x57cm (included 1 Head end filler strip mod.TPA-7) • **DE** Kochplatte + 4 Gaskochstellen auf Statischer Elektro-Backofen cm. 107x55x34h, temp: 50÷300°C , mit 1 Rost cm.105x53 - Platte 37x57 cm (inbegriffen 1 Abschluss-Element mod.TPA-7) • **FR** Toute plaque + 4 brûleurs sur Four électrique statique cm. 107x55x34h, temp: 50÷300°C , avec 1 grille cm.105x53 - Plaque cm. 37x57 (inclus 1 Élément de jonction top mod.TPA-7) • **ES** Placa de cocción + 4 fuegos sobre Horno eléctrico estático cm. 107x55x34h, temp: 50÷300°C , con 1 parilla cm.105x53 - Placa cm 37x57 (incluida 1 Chapa de cierre para top mod.TPA-7)
cm. 120x 70,5x 90h



⚡ 29 kW _____ **6.997,00**
24.940 kcal/h 202 / 1,05

⚡ 6,9 kW _____
400V~3N
50/60 Hz

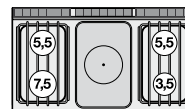

BM-74EM
08050410

BAGNOMARIA MONOFASE SU MOBILE A GIORNO VASCA PER GN 1/1 H.15, RUBINETTO CARICO ACQUA, SCARICO A PAVIMENTO (INCLUSA 1 TESTATA CHIUSURA PIANO MOD. TPA-7)

EN Bain marie singlephase on open cabinet - Bowl for GN 1/1 h.15, water loading cock, floor draining (included 1 Head end filler strip mod. TPA-7) • **DE** Wasserbäder einphasig mit offenem Unterbau - Becken GN 1/1 h.15, Wasserlauf-Hahn, Ablauf am Boden (inbegriffen 1 Abschluss-Element mod.TPA-7) • **FR** Bain marie monophase sur armoire ouvert - Cuve GN 1/1 h.15 - Robinet d'arrivée d'eau, système de vidange au sol (inclus 1 Élément de jonction top mod.TPA-7) • **ES** Baño de maría monofásico sobre mueble abierto Cuba para GN 1/1 15h - Grifo carga agua, descarga a pavimento (incluida 1 Chapa de cierre para top mod. TPA-7)
cm. 40x 70,5x 90h



⚡ 2,1 kW _____ **1.733,00**
230V~ _____ 41 / 0,37
50/60 Hz

BAGNOMARIA ELETTRICI

MOD. _____
COD. _____

DESCRIZIONE/DESCRIPTION/BEZEICHNUNG/DESCRIPTION/DESCRIPCIÓN
DIMENSIONI/DIMENSIONS/ABMESSUNGEN/DIMENSIONS/DIMENSIONES

POTENZA/POWER/LEISTUNG/PUISSANCE/POTENCIA
VOLTAGGIO/VOLTAGE/SPANNUNG/VOLTAGE/VOLTAJE

⚡ kW
kcal/h

⚡ kw
V~
Hz

PREZZO/PRICE
PREIS/PRIX/PRECIO
KG / M³



BM-78ET
08050830

BAGNOMARIA TRIFASE SU MOBILE A GIORNO VASCA PER GN 2/1 15H, RUBINETTO CARICO ACQUA, SCARICO A PAVIMENTO (INCLUSA 1 TESTATA CHIUSURA PIANO MOD. TPA-7)

EN Bain marie threephase on open cabinet - Bowl for GN 2/1 15h, water loading cock, floor draining (included 1 Head end filler strip mod.TPA-7)

• **DE** Wasserbäder Dreiphasig mit offenem Unterbau - Becken GN 2/1 15h, Wasserlauf-Hahn, Ablauf am Boden (inbegriffen 1 Abschluss-Element mod.TPA-7) • **FR** Bain marie triphase sur armoire ouvert Cuve GN 2/1 15h, Robinet d'arrivée d'eau, système de vidange au sol (inclus 1 Élément de jonction top mod.TPA-7) • **ES** Baño de maría trifásico. sobre mueble abierto Cuba para GN 2/1 15h, grifo carga agua, descarga a pavimento (incluida 1 Chapa de cierre para top mod.TPA-7)

cm. 80x 70,5x 90h



⚡ 4,2 kW
400V~2N
230V~3
50/60 Hz

2.452,00
61 / 0,71

BM-74G
08220450

BAGNOMARIA GAS SU MOBILE A GIORNO VASCA PER GN 1/1 H.15, RUBINETTO CARICO ACQUA, SCARICO A PAVIMENTO (INCLUSA 1 TESTATA CHIUSURA PIANO MOD. TPA-7)

EN Gas bain marie on open cabinet - Bowl for GN 1/1 h.15, water loading cock, floor draining (included 1 Head end filler strip mod.TPA-7)

• **DE** Gas Wasserbad mit offenem Unterbau - Becken GN 1/1 h.15, Wasserlauf-Hahn, Ablauf am Boden (inbegriffen 1 Abschluss-Element mod.TPA-7) • **FR** Bain-marie gaz sur armoire ouvert Cuve pour GN 1/1 h.15 - Robinet d'arrivée d'eau, système de vidange au sol (inclus 1 Élément de jonction top mod.TPA-7) • **ES** Baño de maría gas sobre mueble abierto - Cuba para GN 1/1 15h, grifo carga agua, descarga a pavimento (incluida 1 Chapa de cierre para top mod.TPA-7)

cm. 40x 70,5x 90h



⚡ 3,5 kW
3.010 kcal/h

1.799,00
49 / 0,37

BM-78G
08220850

BAGNOMARIA GAS SU MOBILE A GIORNO VASCA PER GN 2/1 H.15, RUBINETTO CARICO ACQUA, SCARICO A PAVIMENTO. (INCLUSA 1 TESTATA CHIUSURA PIANO MOD. TPA-7)

EN Gas bain marie on open cabinet. Bowl for GN 2/1 h.15, water loading cock, floor draining (included 1 Head end filler strip mod.TPA-7)

• **DE** Gas Wasserbad mit offenem Unterbau. Becken GN 2/1 h.15, Wasserlauf-Hahn, Ablauf am Boden. (inbegriffen 1 Abschluss-Element mod.TPA-7) • **FR** Bain-marie gaz sur armoire ouvert. Cuve pour GN 2/1 h.15, robinet d'arrivée d'eau, système de vidange au sol (inclus 1 Élément de jonction top mod.TPA-7) • **ES** Baño de maría gas sobre mueble abierto. Cuba para GN 2/1 15h, grifo carga agua, descarga a pavimento. (incluida 1 Chapa de cierre para top mod.TPA-7)

cm. 80x 70,5x 90h



⚡ 6,5 kW
5.590 kcal/h

2.867,00
68 / 0,71

BS-74EM
08040410

CONTENITORE CALDO CON INFRAROSSO, MONOFASE SU MOBILE A GIORNO VASCA CM. 30,5X51X16,5H CON FALSO FONDO FORATO (INCLUSA 1 TESTATA CHIUSURA PIANO MOD.TPA-7)

EN Fry dump singlephase with infra-red heater on open cabinet. Bowl cm. 30,5x51x16,5h with perforated double bottom (included 1 Head end filler strip mod.TPA-7)

• **DE** Frittenwanne Einphasig mit Infrarotstrahler mit offenem Unterbau. Becke cm. 30,5x51x16,5h mit gelochtem Bodenrost (inbegriffen 1 Abschluss-Element mod.TPA-7) • **FR** Silo a frites monophasé avec infrarouge sur armoire ouvert. Cuve cm 30,5x51x16,5h avec double-fond perforé. (inclus 1 Élément de jonction top mod.TPA-7)

• **ES** Contenedor caliente por infrarrojo, monofásico y sobre mueble abierto. Cuba cm. 30,5x51x16,5h con falso fondo agujereado (incluida 1 Chapa de cierre para top mod.TPA-7)

cm. 40x 70,5x 90h



⚡ 1,47 kW
230V~
50/60 Hz

2.010,00
42 / 0,40

MOD. _____
COD. _____

DESCRIZIONE/DESCRIPTION/BEZEICHNUNG/DESCRIPTION/DESCRIPCIÓN
DIMENSIONI/DIMENSIONS/ABMESSUNGEN/DIMENSIONS/DIMENSIONES

POTENZA/POWER/LEISTUNG/PUISSANCE/POTENCIA
VOLTAGGIO/VOLTAGE/SPANNUNG/VOLTAGE/VOLTAJE

⚡ kW kcal/h
⚡ kw V~ Hz

PREZZO/PRICE PREIS/PRIX/PRECIO
KG / M³



CP-74ET
08100430

CUOCIPASTA TRIFASE LT. 25 VASCA CM. 30,5X33,5X32,7H. RUBINETTO CARICO ACQUA, SFIORATORE + SCARICO A PAVIMENTO. (CESTI ESCLUSI) (INCLUSA 1 TESTATA CHIUSURA PIANO MOD.TPA-7)

EN Pasta cooker threephase 25 lts. Tank cm. 30,5x33,5x32,7h. Water loading cock + overflow device and floor draining (BASKETS EXCLUDED) (included 1 Head end filler strip mod.TPA-7) • **DE** Nudelkocher Dreiphasig lt. 25. Becken cm. 30,5x33,5x32,7h. Wasserlauf-Hahn, + Überlauf-Vorrichtung und Ablauf am Boden (KORB AUSGESCHLOSSEN) (inbegriffen 1 Abschluss-Element mod.TPA-7) • **FR** Cuiseur à pates triphase lt. 25. Cuve cm.30,5x33,5x32,7h. Robinet d'arrivée d'eau trop plein + système de vidange au sol (PANIERS EXCLUS) (inclus 1 Élément de jonction top mod.TPA-7) • **ES** Cuece pasta trifásico. 25 lt. Cuba cm. 30,5x33,5x32,7h. Grifo carga agua + vertedero + descarga a pavimento (CESTAS EXCLUIDAS) (incluida 1 Chapa de cierre para top mod.TPA-7)
cm. 40x 70,5x 90h



⚡ 7,8 kW **2.974,00**
400V~3N 48 / 0,37
50/60 Hz

COMBINAZIONI

- Combinations / • Zusammenstellungen
- Combinaisons / • Combinación múltiple



CPA-74ET
08100435

CUOCIPASTA TRIFASE LT. 25 VASCA CM. 30,5X33,5X32,7H. CARICO ACQUA AUTOMATICO CON SENSORE DI LIVELLO - SFIORATORE + SCARICO A PAVIMENTO (CESTI ESCLUSI) (INCLUSA 1 TESTATA CHIUSURA PIANO MOD.TPA-7)

EN Pasta cooker threephase 25 lts. Tank cm. 30,5x33,5x32,7h. Automatic Water loading with level sensor - overflow device and floor draining (BASKETS EXCLUDED) (included 1 Head end filler strip mod.TPA-7) • **DE** Nudelkocher Dreiphasig lt. 25. Becken cm. 30,5x33,5x32,7h. Automatische Wasser Beladung mit Niveauregulierung + Überlauf-Vorrichtung und Ablauf am Boden (KORB AUSGESCHLOSSEN) (inbegriffen 1 Abschluss-Element mod.TPA-7) • **FR** Cuiseur à pates triphase lt. 25. Cuve cm.30,5x33,5x32,7h. Chargement automatique de l'eau avec sensor de niveau, trop plein Système de vidange au sol (PANIERS EXCLUS) (inclus 1 Élément de jonction top mod.TPA-7) • **ES** Cuece pasta trifásico. 25 lt. Cuba cm. 30,5x33,5x32,7h. Carga automática de agua con sensor de nivel + vertedero + descarga a pavimento. (CESTAS EXCLUIDAS) (incluida 1 Chapa de cierre para top mod.TPA-7)
cm. 40x 70,5x 90h



⚡ 7,8 kW **3.436,00**
400V~3N 48 / 0,37
50/60 Hz

COMBINAZIONI

- Combinations / • Zusammenstellungen
- Combinaisons / • Combinación múltiple



CUOCIPASTA ELETTRICI

MOD. _____
COD. _____

DESCRIZIONE/DESCRIPTION/BEZEICHNUNG/DESCRIPTION/DESCRIPCIÓN
DIMENSIONI/DIMENSIONS/ABMESSUNGEN/DIMENSIONS/DIMENSIONES

POTENZA/POWER/LEISTUNG/PUISSANCE/POTENCIA
VOLTAGGIO/VOLTAGE/SPANNUNG/VOLTAGE/VOLTAJE

⚡ kcal/h ⚡ kw
V~
Hz

PREZZO/PRICE
PREIS/PRIX/PRECIO
KG / M³



CP-76ET
08100630

CUOCIPASTA TRIFASE LT. 40 VASCA CM. 51X30,7X32,7H. RUBINETTO CARICO ACQUA, SFIORATORE + SCARICO A PAVIMENTO. (CESTI ESCLUSI) (INCLUSA 1 TESTATA CHIUSURA PIANO MOD.TPA-7)

EN Pasta cooker threephase 40 lts. Tank cm. 51x30,7x32,7h. Water loading cock + overflow device and floor draining (BASKETS EXCLUDED) (included 1 Head end filler strip mod.TPA-7) • **DE** Nudelkocher Dreiphasig lt. 40. Becken cm. 51x30,7x32,7h. Wasserlauf-Hahn, + Überlauf-Vorrichtung und Ablauf am Boden (KORB AUSGESCHLOSSEN) (inbegriffen 1 Abschluss-Element mod.TPA-7) • **FR** Cuiseur à pates triphase lt. 40. Cuve cm.51x30,7x32,7h. Robinet d'arrivée d'eau trop plein + système de vidange au sol (PANIERS EXCLUS) (inclus 1 Élément de jonction top mod.TPA-7) • **ES** Cuece pasta trifásico 40 lt. Cuba cm. 51x30,7x32,7h. Grifo carga agua + vertedero + descarga a pavimento (CESTAS EXCLUIDAS) (incluida 1 Chapa de cierre para top mod.TPA-7)
cm. 60x 70,5x 90h



⚡ 13,5 kW **3.754,00**
400V~3N 78 / 0,54
50/60 Hz

COMBINAZIONI

- Combinations / • Zusammenstellungen
- Combinaisons / • Combinación múltiple



CPA-76ET
08100635

CUOCIPASTA TRIFASE LT. 40 VASCA CM. 51X30,7X32,7H. CARICO ACQUA AUTOMATICO CON SENSORE DI LIVELLO - SFIORATORE + SCARICO A PAVIMENTO (CESTI ESCLUSI) (INCLUSA 1 TESTATA CHIUSURA PIANO MOD.TPA-7)

EN Pasta cooker threephase 40 lts. Tank cm. 51x30,7x32,7h. Automatic Water loading with level sensor - overflow device and floor draining (BASKETS EXCLUDED) (included 1 Head end filler strip mod.TPA-7) • **DE** Nudelkocher Dreiphasig lt. 40. Becken cm. 51x30,7x32,7h. Automatische Wasser Beladung mit Niveauregulierung + Überlauf-Vorrichtung und Ablauf am Boden (KORB AUSGESCHLOSSEN) (inbegriffen 1 Abschluss-Element mod.TPA-7) • **FR** Cuiseur à pates triphase lt. 40. Cuve cm.51x30,7x32,7h. Chargement automatique de l'eau avec sensor de niveau, trop plein Système de vidange au sol (PANIERS EXCLUS) (inclus 1 Élément de jonction top mod.TPA-7) • **ES** Cuece pasta trifásico 40 lt. Cuba cm. 51x30,7x32,7h. Carga automática de agua con sensor de nivel + vertedero + descarga a pavimento. (CESTAS EXCLUIDAS) (incluida 1 Chapa de cierre para top mod.TPA-7)
cm. 60x 70,5x 90h



⚡ 13,5 kW **4.216,00**
400V~3N 78 / 0,54
50/60 Hz

COMBINAZIONI

- Combinations / • Zusammenstellungen
- Combinaisons / • Combinación múltiple



CUOCIPASTA ELETTRICI

MOD. _____
COD. _____

DESCRIZIONE/DESCRIPTION/BEZEICHNUNG/DESCRIPTION/DESCRIPCIÓN
DIMENSIONI/DIMENSIONS/ABMESSUNGEN/DIMENSIONS/DIMENSIONES

POTENZA/POWER/LEISTUNG/PUISSANCE/POTENCIA
VOLTAGGIO/VOLTAGE/SPANNUNG/VOLTAGE/VOLTAJE

⚡ kW kcal/h
⚡ kw V~ Hz

PREZZO/PRICE
PREIS/PRIX/PRECIO
KG / M³



CP-78ET
08100830

CUOCIPASTA TRIFASE LT. 25+25 2 VASCHE CM. 30,5X33,5X30H. RUBINETTO CARICO ACQUA, SFIORATORE + SCARICO A PAVIMENTO (CESTI ESCLUSI) (INCLUSA 1 TESTATA CHIUSURA PIANO MOD.TPA-7)

EN Pasta cooker threephase 25+25 lts. 2 Tanks cm. 30,5x33,5x30h. Water loading cock + overflow device and floor draining (BASKETS EXCLUDED) (included 1 Head end filler strip mod.TPA-7) • **DE** Nudelkocher dreiphasig lt. 25+25 2 Becken cm. 30,5x33,5x30h. Wasserlauf-Hahn, + Überlauf-Vorrichtung und Ablauf am Boden (KORB AUSGESCHLOSSEN) (inbegriffen 1 Abschluss-Element mod.TPA-7) • **FR** Cuiseur à pates triphase lt. 25+25 2 Cuves cm.30,5x33,5x30h. Robinet d'arrivée d'eau trop plein + système de vidange au sol En (PANIERS EXCLUS) (inclus 1 Élément de jonction top mod.TPA-7) • **ES** Cuece pasta trifásico. 25+25 lt. 2 Cubas cm. 30,5x33,5x30h. Grifo carga agua + vertedero + descarga a pavimento (CESTAS EXCLUIDAS) (incluida 1 Chapa de cierre para top mod.TPA-7)
cm. 80x 70,5x 90h



⚡ 15,6 kW 4.992,00
400V~3N 82 / 0,71
50/60 Hz

COMBINAZIONI

- Combinations / • Zusammenstellungen
- Combinaisons / • Combinación múltiple



CPA-78ET
08100835

CUOCIPASTA TRIFASE LT. 25+25 2 VASCHE CM. 30,5X33,5X30H. CARICO ACQUA AUTOMATICO CON SENSORE DI LIVELLO - SFIORATORE + SCARICO A PAVIMENTO (CESTI ESCLUSI) (INCLUSA 1 TESTATA CHIUSURA PIANO MOD.TPA-7)

EN Pasta cooker threephase 25+25 lts. 2 Tanks cm. 30,5x33,5x30h. Automatic Water loading with level sensor - overflow device and floor draining (BASKETS EXCLUDED) (included 1 Head end filler strip mod.TPA-7) • **DE** Nudelkocher dreiphasig lt. 25+25 2 Becken cm. 30,5x33,5x30h. Automatische Wasser Beladung mit Niveauregulierung + Überlauf-Vorrichtung und Ablauf am Boden (KORB AUSGESCHLOSSEN) (inbegriffen 1 Abschluss-Element mod.TPA-7) • **FR** Cuiseur à pates triphase lt. 25+25 2 Cuves cm.30,5x33,5x30h. Chargement automatique de l'eau avec sensor de niveau, trop plein Système de vidange au sol (PANIERS EXCLUS) (inclus 1 Élément de jonction top mod.TPA-7) • **ES** Cuece pasta trifásico. 25+25 lt. 2 Cubas cm. 30,5x33,5x30h. Carga automática de agua con sensor de nivel + vertedero + descarga a pavimento. (CESTAS EXCLUIDAS) (incluida 1 Chapa de cierre para top mod.TPA-7)
cm. 80x 70,5x 90h



⚡ 15,6 kW 5.454,00
400V~3N 82 / 0,71
50/60 Hz

COMBINAZIONI

- Combinations / • Zusammenstellungen
- Combinaisons / • Combinación múltiple



CUOCIPASTA A GAS

MOD. _____
COD. _____

DESCRIZIONE/DESCRIPTION/BEZEICHNUNG/DESCRIPTION/DESCRIPCIÓN
DIMENSIONI/DIMENSIONS/ABMESSUNGEN/DIMENSIONS/DIMENSIONES

POTENZA/POWER/LEISTUNG/PUISSANCE/POTENCIA
VOLTAGGIO/VOLTAGE/SPANNUNG/VOLTAGE/VOLTAJE

9,5 kW
8.160 kcal/h

PREZZO/PRICE
PREIS/PRIX/PRECIO
KG / M³



CP-74G
08270450

**CUOCIPASTA GAS LT 25 VASCA CM. 30,5X33,5X32,7H.
RUBINETTO CARICO ACQUA, SFIORATORE + SCARICO A
PAVIMENTO. (CESTI ESCLUSI) (INCLUSA 1 TESTATA CHIUSURA
PIANO MOD.TPA-7)**

EN Gas pasta cooker 25 lts. Tank cm. 30,5x33,5x32,7h. Water loading
cock + overflow device and floor draining (BASKETS EXCLUDED) (included
1 Head end filler strip mod.TPA-7) • **DE** Gas-Nudelkocher lt. 25.
Becken cm. 30,5x33,5x32,7h. Wasserlauf-Hahn, + Überlauf-Vorrichtung
und Ablauf am Boden (KORB AUSGESCHLOSSEN) (inbegriffen 1
Abschluss-Element mod.TPA-7) • **FR** Cuiseur à pâtes gaz lt. 25. Cuve
cm.30,5x33,5x32,7h. Robinet d'arrivée d'eau trop plein + système de
vidange au sol (PANIERS EXCLUS) (inclus 1 Élément de jonction top mod.
TPA-7) • **ES** Cuece pasta gas 25 lt. Cuba cm. 30,5x33,5x32,7h. Grifo
carga agua + vertedero + descarga a pavimento (CESTAS EXCLUIDAS)
(incluida 1 Chapa de cierre para top mod.TPA-7)
cm. 40x 70,5x 90h



9,5 kW
8.160 kcal/h **3.537,00**
61 / 0,37

0,02 KW
230V~
50/60 Hz

COMBINAZIONI

- Combinations / • Zusammenstellungen
- Combinaisons / • Combinación múltiple



CPA-74G
08270455

**CUOCIPASTA GAS LT 25 VASCA CM. 30,5X33,5X32,7H.
CARICO ACQUA AUTOMATICO CON SENSORE DI LIVELLO
- SFIORATORE + SCARICO A PAVIMENTO (CESTI ESCLUSI)
(INCLUSA 1 TESTATA CHIUSURA PIANO MOD.TPA-7)**

EN Gas pasta cooker 25 lts. Tank cm. 30,5x33,5x32,7h. Automatic
Water loading with level sensor - overflow device and floor draining
(BASKETS EXCLUDED) (included 1 Head end filler strip mod.TPA-7) • **DE**
Gas-Nudelkocher lt. 25. Becken cm. 30,5x33,5x32,7h. Automatische
Wasser Beladung mit Niveauregulierung + Überlauf-Vorrichtung
und Ablauf am Boden (KORB AUSGESCHLOSSEN) (inbegriffen 1
Abschluss-Element mod.TPA-7) • **FR** Cuiseur à pâtes gaz lt. 25. Cuve
cm.30,5x33,5x32,7h. Chargement automatique de l'eau avec sensor de
niveau, trop plein Système de vidange au sol (PANIERS EXCLUS) (inclus 1
Élément de jonction top mod.TPA-7) • **ES** Cuece pasta gas 25 lt. Cuba
cm. 30,5x33,5x32,7h. Carga automática de agua con sensor de nivel
+ vertedero + descarga a pavimento. (CESTAS EXCLUIDAS) (incluida 1
Chapa de cierre para top mod.TPA-7)
cm. 40x 70,5x 90h



9,5 kW
8.160 kcal/h **3.801,00**
61 / 0,37

0,035 KW
230V~
50/60 Hz

COMBINAZIONI

- Combinations / • Zusammenstellungen
- Combinaisons / • Combinación múltiple



MOD. _____
COD. _____

DESCRIZIONE/DESCRIPTION/BEZEICHNUNG/DESCRIPTION/DESCRIPCIÓN
DIMENSIONI/DIMENSIONS/ABMESSUNGEN/DIMENSIONS/DIMENSIONES

POTENZA/POWER/LEISTUNG/PUISSANCE/POTENCIA
VOLTAGGIO/VOLTAGE/SPANNUNG/VOLTAGE/VOLTAJE

⚡ kW kcal/h
⚡ kW V~ Hz

PREZZO/PRICE
PREIS/PRIX/PRECIO
KG / M³



CP-76G
08270650

CUOCIPASTA GAS LT 40 VASCA CM. 51X30,7X32,7H. RUBINETTO CARICO ACQUA, SFIORATORE + SCARICO A PAVIMENTO. (CESTI ESCLUSI) (INCLUSA 1 TESTATA CHIUSURA PIANO MOD.TPA-7)

EN Gas pasta cooker 40 lts. Tank cm. 51x30,7x32,7h. Water loading cock + overflow device and floor draining (BASKETS EXCLUDED) (included 1 Head end filler strip mod.TPA-7) • **DE** Gas-Nudelkocher lt. 40. Becken cm. 51x30,7x32,7h. Wasserlauf-Hahn, + Überlauf-Vorrichtung und Ablauf am Boden (KORB AUSGESCHLOSSEN) (inbegriffen 1 Abschluss-Element mod.TPA-7) • **FR** Cuiseur à pates gaz lt. 40. Cuve cm.51x30,7x32,7h. Robinet d'arrivée d'eau trop plein + système de vidange au sol (PANIERS EXCLUS) (inclus 1 Élément de jonction top mod.TPA-7) • **ES** Cuece pasta gas 40 lt. Cuba cm. 51x30,7x32,7h. Grifo carga agua + vertedero + descarga a pavimento (CESTAS EXCLUIDAS) (incluida 1 Chapa de cierre para top mod.TPA-7)
cm. 60x 70,5x 90h



⚡ 13,95 kW
11.997 kcal/h **3.843,00**
80 / 0,54

⚡ 0,02 KW
230V~
50/60 Hz

COMBINAZIONI

- Combinations / • Zusammenstellungen
- Combinaisons / • Combinación múltiple



CPA-76G
08270655

CUOCIPASTA GAS LT 40 VASCA CM. 51X30,7X32,7H. CARICO ACQUA AUTOMATICO CON SENSORE DI LIVELLO - SFIORATORE + SCARICO A PAVIMENTO (CESTI ESCLUSI) (INCLUSA 1 TESTATA CHIUSURA PIANO MOD.TPA-7)

EN Gas pasta cooker 40 lts. Tank cm. 51x30,7x32,7h. Automatic Water loading with level sensor - overflow device and floor draining (BASKETS EXCLUDED) (included 1 Head end filler strip mod.TPA-7) • **DE** Gas-Nudelkocher lt. 40. Becken cm. 51x30,7x32,7h. Automatische Wasser Beladung mit Niveauregulierung + Überlauf-Vorrichtung und Ablauf am Boden (KORB AUSGESCHLOSSEN) (inbegriffen 1 Abschluss-Element mod.TPA-7) • **FR** Cuiseur à pates gaz lt. 40. Cuve cm.51x30,7x32,7h. Chargement automatique de l'eau avec sensor de niveau, trop plein Système de vidange au sol (PANIERS EXCLUS) (inclus 1 Élément de jonction top mod.TPA-7) • **ES** Cuece pasta gas 40 lt. Cuba cm. 51x30,7x32,7h. Carga automática de agua con sensor de nivel + vertedero + descarga a pavimento. (CESTAS EXCLUIDAS) (incluida 1 Chapa de cierre para top mod.TPA-7)
cm. 60x 70,5x 90h



⚡ 13,95 kW
11.997 kcal/h **4.107,00**
80 / 0,54

⚡ 0,035 KW
230V~
50/60 Hz

COMBINAZIONI

- Combinations / • Zusammenstellungen
- Combinaisons / • Combinación múltiple



CUOCIPASTA A GAS

MOD. _____
COD. _____

DESCRIZIONE/DESCRIPTION/BEZEICHNUNG/DESCRIPTION/DESCRIPCIÓN
DIMENSIONI/DIMENSIONS/ABMESSUNGEN/DIMENSIONS/DIMENSIONES

POTENZA/POWER/LEISTUNG/PUISSANCE/POTENCIA
VOLTAGGIO/VOLTAGE/SPANNUNG/VOLTAGE/VOLTAJE

⚡ kW kcal/h
⚡ kW V~ Hz

PREZZO/PRICE
PREIS/PRIX/PRECIO
KG / M³



CP-78G
08270850

CUOCIPASTA GAS LT. 25+25 2 VASCHE CM. 30,5X33,5X32,7H. RUBINETTO CARICO ACQUA, SFIORATORE + SCARICO A PAVIMENTO (CESTI ESCLUSI) (INCLUSA 1 TESTATA CHIUSURA PIANO MOD.TPA-7)

EN Gas pasta cooker 25+25 lts. 2 Tanks cm. 30,5x33,5x32,7h. Water loading cock + overflow device and floor draining. (BASKETS EXCLUDED) (included 1 Head end filler strip mod.TPA-7) • **DE** Gas-Nudelkocher lt. 25+25 2 Becken cm. 30,5x33,5x32,7h. Wasserlauf-Hahn, + Überlauf-Vorrichtung und Ablauf am Boden (KORB AUSGESCHLOSSEN) (inbegriffen 1 Abschluss-Element mod.TPA-7) • **FR** Cuiseur à patges gaz lt. 25+25 2 Cuves cm.30,5x33,5x32,7h. robinet d'arrivée d'eau trop plein + système de vidange au sol (PANIERS EXCLUS) (inclus 1 Élément de jonction top mod.TPA-7) • **ES** Cuece pasta gas 25+25 lt. 2 Cubas cm. 30,5x33,5x32,7h. Grifo carga agua + vertedero + descarga a pavimento (CESTAS EXCLUIDAS) (incluida 1 Chapa de cierre para top mod.TPA-7)
cm. 80x 70,5x 90h



⚡ 19 kW 5.534,00
16.320 kcal/h 103 / 0,71

⚡ 0,04 KW
230V~
50/60 Hz

COMBINAZIONI

- Combinations / • Zusammenstellungen
- Combinaisons / • Combinación múltiple



CPA-78G
08270855

CUOCIPASTA GAS LT. 25+25 2 VASCHE CM. 30,5X33,5X32,7H. CARICO ACQUA AUTOMATICO CON SENSORE DI LIVELLO - SFIORATORE + SCARICO A PAVIMENTO (CESTI ESCLUSI) (INCLUSA 1 TESTATA CHIUSURA PIANO MOD.TPA-7)

EN Gas pasta cooker 25+25 lts. 2 Tanks cm. 30,5x33,5x32,7h. Automatic Water loading with level sensor - overflow device and floor draining (BASKETS EXCLUDED) (included 1 Head end filler strip mod.TPA-7) • **DE** Gas-Nudelkocher lt. 25+25 2 Becken cm. 30,5x33,5x32,7h. Automatische Wasser Beladung mit Niveauregulierung + Überlauf-Vorrichtung und Ablauf am Boden (KORB AUSGESCHLOSSEN) (inbegriffen 1 Abschluss-Element mod.TPA-7) • **FR** Cuiseur à patges gaz lt. 25+25 2 Cuves cm.30,5x33,5x32,7h. Chargement automatique de l'eau avec sensor de niveau, trop plein Système de vidange au sol (PANIERS EXCLUS) (inclus 1 Élément de jonction top mod.TPA-7) • **ES** Cuece pasta gas 25+25 lt. 2 Cubas cm. 30,5x33,5x32,7h. Carga automática de agua con sensor de nivel + vertedero + descarga a pavimento. (CESTAS EXCLUIDAS) (incluida 1 Chapa de cierre para top mod.TPA-7)
cm. 80x 70,5x 90h



⚡ 19 kW 6.064,00
16.320 kcal/h 103 / 0,71

⚡ 0,07 KW
230V~
50/60 Hz

COMBINAZIONI

- Combinations / • Zusammenstellungen
- Combinaisons / • Combinación múltiple



SOLLEVATORE CESTI

MOD. _____
COD. _____

DESCRIZIONE/DESCRIPTION/BEZEICHNUNG/DESCRIPTION/DESCRIPCIÓN
DIMENSIONI/DIMENSIONS/ABMESSUNGEN/DIMENSIONS/DIMENSIONES

POTENZA/POWER/LEISTUNG/PUISSANCE/POTENCIA
VOLTAGGIO/VOLTAGE/SPANNUNG/VOLTAGE/VOLTAJE

⚡ kW _____
kcal/h _____
V~ _____
Hz _____

PREZZO/PRICE
PREIS/PRIX/PRECIO
KG / M³



SCCP-72EM
08140210

SOLLEVATORE CESTI DA AFFIANCARE AI CUOCIPASTA CP-74/78, SOLLEVAMENTO AUTOMATICO TEMPORIZZATO O MANUALE, 2 ASTE (INCLUSA 1 TESTATA CHIUSURA PIANO MOD.TPA-7)

EN basket elevator for pasta cooker CP-74/78, automatic timed or manual lifting, 2 rods (included 1 Head end filler strip mod.TPA-7) • **DE** heben Korbe für Nudelkocher CP-74/78, Timed oder manuelle Heben, 2 Stangen (inbegriffen 1 Abschluss-Element mod.TPA-7) • **FR** soulever des paniers pour cuiseur a pates CP-74/78, soulèvement temporisé ou manuel, 2 tiges (inclus 1 Elément de jonction top mod.TPA-7) • **ES** levantar cestas para cuece pasta CP-74/78, elevación temporizado o manual, 2 barras (incluida 1 Chapa de cierre para top mod.TPA-7)

cm. **20x 70,5x 90h**



⚡ 0,35 kW _____ **3.239,00**
230V~ _____ 45 / 0,37
50/60 Hz

COMBINAZIONI

- Combinations / • Zusammenstellungen
- Combinaisons / • Combinación múltiple

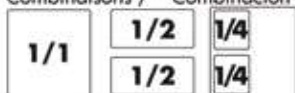

PI50-78ET
08110831

PENTOLA INDIRETTA ELETTRICA LT. 50 VASCA Ø CM. 40X45H (INCLUSA 1 TESTATA CHIUSURA PIANO MOD.TPA-7)

EN Electric indirect boiling pan 50 lts. Tank Ø cm. 40x45h (included 1 Head end filler strip mod.TPA-7) • **DE** Indirekter Elektro-kochkessel lt. 50 Becken Ø cm. 40x45h (inbegriffen 1 Abschluss-Element mod.TPA-7) • **FR** Marmite indirecte électrique lt. 50 Cuve Ø cm. 40x45h (inclus 1 Elément de jonction top mod.TPA-7) • **ES** Marmita de calefacción indirecta 50 lt. Cuba Ø cm. 40x45h (incluida 1 Chapa de cierre para top mod.TPA-7)

cm. **80x 70,5x 90h**



⚡ 9 kW _____ **7.322,00**
400V~3N _____ 120 / 0,71
50/60 Hz

PI50A-78ET
0811A831

PENTOLA INDIRETTA ELETTRICA LT. 50 VASCA Ø CM. 40X45H - CARICO AUTOMATICO INTERCAPEDINE (INCLUSA 1 TESTATA CHIUSURA PIANO MOD.TPA-7)

EN Electric indirect boiling pan 50 lts. Tank Ø cm. 40x45h - automatic water-charge of double jacket. (included 1 Head end filler strip mod.TPA-7) • **DE** Indirekter Elektro-kochkessel lt. 50 Becken Ø cm. 40x45h - automatische Wasserstandskontrolle im Zwischenmantel (inbegriffen 1 Abschluss-Element mod.TPA-7) • **FR** Marmite indirecte électrique lt. 50 Cuve Ø cm. 40x45h - remplissage automatique dans la double paroi (inclus 1 Elément de jonction top mod.TPA-7) • **ES** Marmita de calefacción indirecta 50 lt. Cuba Ø cm. 40x45h - carga automática de la camisa intercambiador (incluida 1 Chapa de cierre para top mod.TPA-7)

cm. **80x 70,5x 90h**

⚡ 9 kW _____ **9.544,00**
400V~3N _____ 120 / 0,71
50/60 Hz

PD50-78G
08280850

PENTOLA DIRETTA GAS LT. 50 VASCA Ø CM. 40X45H (INCLUSA 1 TESTATA CHIUSURA PIANO MOD.TPA-7)

EN Gas direct boiling pan 50 lts. - Tank Ø cm. 40x45h (included 1 Head end filler strip mod.TPA-7) • **DE** Direkter Gas-Kochkessel lt. 50 - Becken Ø cm. 40x45h (inbegriffen 1 Abschluss-Element mod.TPA-7) • **FR** Marmite directe à gaz lt. 50 - Cuve Ø cm. 40x45h (inclus 1 Elément de jonction top mod.TPA-7) • **ES** Marmita de calefacción directa 50 lt. Cuba Ø cm. 40x45h (incluida 1 Chapa de cierre para top mod.TPA-7)

cm. **80x 70,5x 90h**



⚡ 15,5 kW _____ **5.908,00**
13.330 kcal/h _____ 110 / 0,71

PI50-78G
08280851

PENTOLA INDIRETTA A GAS LT. 50 VASCA Ø CM. 40X45H (INCLUSA 1 TESTATA CHIUSURA PIANO MOD.TPA-7)

EN Gas indirect boiling pan 50 lts. - Tank Ø cm. 40x45h (included 1 Head end filler strip mod.TPA-7) • **DE** Indirekter Gas-Kochkessel lt. 50 - Becken Ø cm. 40x45h (inbegriffen 1 Abschluss-Element mod.TPA-7) • **FR** Marmite indirecte à gaz lt. 50 - Cuve Ø cm. 40x45h (inclus 1 Elément de jonction top mod.TPA-7) • **ES** Marmita de calefacción indirecta a gas lt. 50 Cuba Ø cm. 40x45h (incluida 1 Chapa de cierre para top mod.TPA-7)

cm. **80x 70,5x 90h**

⚡ 15,5 kW _____ **7.661,00**
13.330 kcal/h _____ 120 / 0,71

PENTOLE A GAS

MOD. _____
COD. _____

DESCRIZIONE/DESCRIPTION/BEZEICHNUNG/DESCRIPTION/DESCRIPCIÓN
DIMENSIONI/DIMENSIONS/ABMESSUNGEN/DIMENSIONS/DIMENSIONES

POTENZA/POWER/LEISTUNG/PUISSANCE/POTENCIA
VOLTAGGIO/VOLTAGE/SPANNUNG/VOLTAGE/VOLTAJE

⚡ 15,5 kW
13.330 kcal/h

PREZZO/PRICE
PREIS/PRIX/PRECIO
KG / M³



P150A-78G
0828A851

PENTOLA INDIRETTA A GAS LT. 50 VASCA Ø CM. 40X45H - CARICO AUTOMATICO INTERCAPEDINE (INCLUSA 1 TESTATA CHIUSURA PIANO MOD.TPA-7)

EN Gas indirect boiling pan 50 lts. - Tank Ø cm. 40x45h - automatic water-charge of double jacket. (included 1 Head end filler strip mod. TPA-7) • **DE** Indirekter Gas-Kochkessel lt. 50 - Becken Ø cm. 40x45h - automatische Wasserstandskontrolle im Zwischenmantel (inbegriffen 1 Abschluss-Element mod.TPA-7) • **FR** Marmite indirecte à gaz lt. 50 - Cuve Ø cm. 40x45h - remplissage automatique dans la double paroi (inclus 1 Élément de jonction top mod.TPA-7) • **ES** Marmita de calefacción indirecta a gas lt. 50 Cuba Ø cm. 40x45h - carga automática de la camisa intercambiador (incluida 1 Chapa de cierre para top mod. TPA-7)

cm. 80x 70,5x 90h



⚡ 15,5 kW
13.330 kcal/h

10.070,00
120 / 0,71

⚡ 0.1
230V~
50/60 Hz

531032701

OPTIONAL: CESTO 1/1 PER PENTOLA

EN Optional: Basket 1/1 for boiling pan • **DE** Zubehör: Korb 1/1 für Kochkessel • **FR** En option: Panier 1/1 pour marmite • **ES** Opcional: Cesta 1/1 por marmita

cm.Ø 36x 39,5h

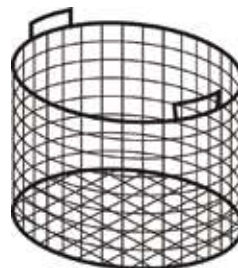

896,00
5 / 0,08

FTL-74ET
08060431

FRY-TOP ELETTRICO LISCIO, SU MOBILE A GIORNO, PIASTRA CM.36X51 (INCLUSA 1 TESTATA CHIUSURA PIANO MOD. TPA-7)

EN Electric Fry-top smooth griddle, on open cabinet, plate cm.36x51 (included 1 Head end filler strip mod.TPA-7) • **DE** Griddleplatte elektrische glatt, mit offenem Unterbau, platte cm.36x51 (inbegriffen 1 Abschluss-Element mod.TPA-7) • **FR** Plaque électriques lisse, sur armoire ouvert, plaque cm.36x51 (inclus 1 Élément de jonction top mod.TPA-7) • **ES** Fry-top eléctrico liso, sobre mueble abierto, plancha cm.36x51 (incluida 1 Chapa de cierre para top mod.TPA-7)

cm. 40x 70,5x 90h



⚡ 5,55 kW
400V~3N
230V~3
50/60 Hz

2.140,00
64 / 0,37

FTL-74ETS
08060434

FRY-TOP ELETTRICO LISCIO CROMATO SUPERCHROME (MOCA APPROVED), SU MOBILE A GIORNO, PIASTRA CM.36X51 (INCLUSA 1 TESTATA CHIUSURA PIANO MOD.TPA-7)

EN Electric Fry-top smooth chromed griddle SUPERCHROME (Moca Approved), on open cabinet, plate cm.36x51 (included 1 Head end filler strip mod.TPA-7) • **DE** Griddleplatte elektrische glatt hartverchromt SUPERCHROME (Moca Approved), mit offenem Unterbau, platte cm.36x51 (inbegriffen 1 Abschluss-Element mod.TPA-7) • **FR** Plaque électriques lisse chromée SUPERCHROME (Moca Approved), sur armoire ouvert, plaque cm.36x51 (inclus 1 Élément de jonction top mod.TPA-7) • **ES** Fry-top eléctrico liso cromado SUPERCHROME (Moca Approved), sobre mueble abierto, plancha cm.36x51 (incluida 1 Chapa de cierre para top mod.TPA-7)

cm. 40x 70,5x 90h

⚡ 5,55 kW
400V~3N
230V~3
50/60 Hz

2.552,00
64 / 0,37

FTL-74ETSS
08060430

FRY-TOP ELETTRICO LISCIO CROMO LUCIDO, SU MOBILE A GIORNO, PIASTRA CM.36X51 (INCLUSA 1 TESTATA CHIUSURA PIANO MOD.TPA-7)

EN Electric Fry-top smooth POLISHED CHROME, on open cabinet, plate cm.36x51 (included 1 Head end filler strip mod.TPA-7) • **DE** Griddleplatte elektrische glatt POLIERTEM CHROM, mit offenem Unterbau, platte cm.36x51 (inbegriffen 1 Abschluss-Element mod.TPA-7) • **FR** Plaque électriques lisse CHROME POLI, sur armoire ouvert, plaque cm.36x51 (inclus 1 Élément de jonction top mod.TPA-7) • **ES** Fry-top eléctrico liso CROMO PULIDO, sobre mueble abierto, plancha cm.36x51 (incluida 1 Chapa de cierre para top mod.TPA-7)

cm. 40x 70,5x 90h

⚡ 5,55 kW
400V~3N
230V~3
50/60 Hz

2.552,00
64 / 0,37

FRY-TOP ELETTRICI

MOD. _____
COD. _____

DESCRIZIONE/DESCRIPTION/BEZEICHNUNG/DESCRIPTION/DESCRIPCIÓN
DIMENSIONI/DIMENSIONS/ABMESSUNGEN/DIMENSIONS/DIMENSIONES

POTENZA/POWER/LEISTUNG/PUISSANCE/POTENCIA
VOLTAGGIO/VOLTAGE/SPANNUNG/VOLTAGE/VOLTAJE

⚡ kW kcal/h
⚡ kw V~ Hz

PREZZO/PRICE
PREIS/PRIX/PRECIO
KG / M³



FTR-74ET
08060433

FRY-TOP ELETTRICO RIGATO, SU MOBILE A GIORNO, PIASTRA CM.36X51 (INCLUSA 1 TESTATA CHIUSURA PIANO MOD. TPA-7)

EN Electric Fry-top grooved griddle, on open cabinet, plate cm.36x51 (included 1 Head end filler strip mod.TPA-7) • **DE** Griddleplatte elektrische gerillt, mit offenem Unterbau, platte cm.36x51 (inbegriffen 1 Abschluss-Element mod.TPA-7) • **FR** Plaque électriques nervurée, sur armoire ouvert, plaque cm.36x51 (inclus 1 Élément de jonction top mod. TPA-7) • **ES** Fry-top eléctrico estriado, sobre mueble abierto, plancha cm.36x51 (incluida 1 Chapa de cierre para top mod.TPA-7)
cm. 40x 70,5x 90h



⚡ 5,55 kW **2.283,00**
400V~3N 64 / 0,37
230V~3
50/60 Hz



FTR-74ETS
08060436

FRY-TOP ELETTRICO RIGATO CROMATO SUPERCHROME (MOCA APPROVED), SU MOBILE A GIORNO, PIASTRA CM.36X51 (INCLUSA 1 TESTATA CHIUSURA PIANO MOD. TPA-7)

EN Electric Fry-top grooved chromed griddle SUPERCHROME (Moca Approved), on open cabinet, plate cm.36x51 (included 1 Head end filler strip mod.TPA-7) • **DE** Griddleplatte elektrische gerillt hartverchromt SUPERCHROME (Moca Approved), mit offenem Unterbau, platte cm.36x51 (inbegriffen 1 Abschluss-Element mod.TPA-7) • **FR** Plaque électriques nervurée chromée SUPERCHROME (Moca Approved), sur armoire ouvert, plaque cm.36x51 (inclus 1 Élément de jonction top mod. TPA-7) • **ES** Fry-top eléctrico estriado cromado SUPERCHROME (Moca Approved), sobre mueble abierto, plancha cm.36x51 (incluida 1 Chapa de cierre para top mod.TPA-7)
cm. 40x 70,5x 90h

⚡ 5,55 kW **2.642,00**
400V~3N 64 / 0,37
230V~3
50/60 Hz



FTL-76ET
08060631

FRY-TOP ELETTRICO LISCIO, SU MOBILE A GIORNO, PIASTRA CM.56X51 (INCLUSA 1 TESTATA CHIUSURA PIANO MOD. TPA-7)

EN Electric Fry-top smooth griddle, on open cabinet, plate cm.56x51 (included 1 Head end filler strip mod.TPA-7) • **DE** Griddleplatte elektrische glatt, mit offenem Unterbau, platte cm.56x51 (inbegriffen 1 Abschluss-Element mod.TPA-7) • **FR** Plaque électriques lisse, sur armoire ouvert, plaque cm.56x51 (inclus 1 Élément de jonction top mod.TPA-7) • **ES** Fry-top eléctrico liso, sobre mueble abierto, plancha cm.56x51 (incluida 1 Chapa de cierre para top mod.TPA-7)
cm. 60x 70,5x 90h



⚡ 7,4 kW **2.585,00**
400V~3N 78 / 0,54
50/60 Hz

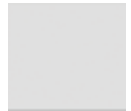

FTL-76ETS
08060634

FRY-TOP ELETTRICO LISCIO CROMATO SUPERCHROME (MOCA APPROVED), SU MOBILE A GIORNO, PIASTRA CM.56X51 (INCLUSA 1 TESTATA CHIUSURA PIANO MOD.TPA-7)

EN Electric Fry-top smooth chromed griddle SUPERCHROME (Moca Approved), on open cabinet, plate cm.56x51 (included 1 Head end filler strip mod.TPA-7) • **DE** Griddleplatte elektrische glatt hartverchromt SUPERCHROME (Moca Approved), mit offenem Unterbau, platte cm.56x51 (inbegriffen 1 Abschluss-Element mod.TPA-7) • **FR** Plaque électriques lisse chromée SUPERCHROME (Moca Approved), sur armoire ouvert, plaque cm.56x51 (inclus 1 Élément de jonction top mod.TPA-7) • **ES** Fry-top eléctrico liso cromado SUPERCHROME (Moca Approved), sobre mueble abierto, plancha cm.56x51 (incluida 1 Chapa de cierre para top mod.TPA-7)
cm. 60x 70,5x 90h

⚡ 7,4 kW **3.012,00**
400V~3N 78 / 0,54
50/60 Hz

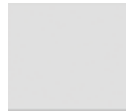

FTL-76ETSS
08060630

FRY-TOP ELETTRICO LISCIO CROMO LUCIDO, SU MOBILE A GIORNO, PIASTRA CM.56X51 (INCLUSA 1 TESTATA CHIUSURA PIANO MOD.TPA-7)

EN Electric Fry-top smooth POLISHED CHROME, on open cabinet, plate cm.56x51 (included 1 Head end filler strip mod.TPA-7) • **DE** Griddleplatte elektrische glatt POLIERTEM CHROM, mit offenem Unterbau, platte cm.56x51 (inbegriffen 1 Abschluss-Element mod.TPA-7) • **FR** Plaque électriques lisse CHROME POLI, sur armoire ouvert, plaque cm.56x51 (inclus 1 Élément de jonction top mod.TPA-7) • **ES** Fry-top eléctrico liso CROMO PULIDO, sobre mueble abierto, plancha cm.56x51 (incluida 1 Chapa de cierre para top mod.TPA-7)
cm. 60x 70,5x 90h

⚡ 7,4 kW **3.012,00**
400V~3N 78 / 0,54
50/60 Hz

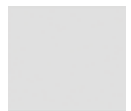

FRY-TOP ELETTRICI

MOD. _____
COD. _____

DESCRIZIONE/DESCRIPTION/BEZEICHNUNG/DESCRIPTION/DESCRIPCIÓN
DIMENSIONI/DIMENSIONS/ABMESSUNGEN/DIMENSIONS/DIMENSIONES

POTENZA/POWER/LEISTUNG/PUISSANCE/POTENCIA
VOLTAGGIO/VOLTAGE/SPANNUNG/VOLTAGE/VOLTAJE

⚡ kW kcal/h
⚡ kW V~ Hz

PREZZO/PRICE
PREIS/PRIX/PRECIO
KG / M³



FTLR-76ET
08060632

FRY-TOP ELETTRICO 1/2 RIGATO + 1/2 LISCIO, SU MOBILE A GIORNO, PIASTRA CM.56X51 (INCLUSA 1 TESTATA CHIUSURA PIANO MOD.TPA-7)

EN Electric Fry-top 1/2 grooved + 1/2 smooth, on open cabinet, plate cm.56x51 (included 1 Head end filler strip mod.TPA-7) • **DE** Griddleplatte elektrische 1/2 gerillt + 1/2 glatt, mit offenem Unterbau, platte cm.56x51 (inbegriffen 1 Abschluss-Element mod.TPA-7) • **FR** Plaque électriques 1/2 nervurée + 1/2 lisse, sur armoire ouvert, plaque cm.56x51 (inclus 1 Élément de jonction top mod.TPA-7) • **ES** Fry-top eléctrico 1/2 estriado + 1/2 liso, sobre mueble abierto, plancha cm.56x51 (incluida 1 Chapa de cierre para top mod.TPA-7)
cm. 60x 70,5x 90h

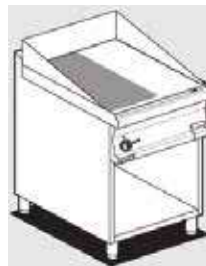

⚡ 7,4 kW **2.664,00**
400V~3N 78 / 0,54
50/60 Hz



FTLR-76ETS
08060635

FRY-TOP ELETTRICO 1/2 RIGATO + 1/2 LISCIO CROMATO SUPERCHROME (MOCA APPROVED), SU MOBILE A GIORNO, PIASTRA CM.56X51 (INCLUSA 1 TESTATA CHIUSURA PIANO MOD.TPA-7)

EN Electric Fry-top 1/2 grooved + 1/2 smooth chromed griddle SUPERCHROME (Moca Approved), on open cabinet, plate cm.56x51 (included 1 Head end filler strip mod.TPA-7) • **DE** Griddleplatte elektrische 1/2 gerillt + 1/2 glatt hartverchromt SUPERCHROME (Moca Approved), mit offenem Unterbau, platte cm.56x51 (inbegriffen 1 Abschluss-Element mod.TPA-7) • **FR** Plaque électriques 1/2 nervurée + 1/2 lisse chromée SUPERCHROME (Moca Approved), sur armoire ouvert, plaque cm.56x51 (inclus 1 Élément de jonction top mod.TPA-7) • **ES** Fry-top eléctrico 1/2 estriado + 1/2 liso cromado SUPERCHROME (Moca Approved), sobre mueble abierto, plancha cm.56x51 (incluida 1 Chapa de cierre para top mod.TPA-7)
cm. 60x 70,5x 90h

⚡ 7,4 kW **3.144,00**
400V~3N 78 / 0,54
50/60 Hz



FTR-76ET
08060633

FRY-TOP ELETTRICO RIGATO, SU MOBILE A GIORNO, PIASTRA CM.56X51 (INCLUSA 1 TESTATA CHIUSURA PIANO MOD.TPA-7)

EN Electric Fry-top grooved griddle, on open cabinet, plate cm.56x51 (included 1 Head end filler strip mod.TPA-7) • **DE** Griddleplatte elektrische gerillt, mit offenem Unterbau, platte cm.56x51 (inbegriffen 1 Abschluss-Element mod.TPA-7) • **FR** Plaque électriques nervurée, sur armoire ouvert, plaque cm.56x51 (inclus 1 Élément de jonction top mod.TPA-7) • **ES** Fry-top eléctrico estriado, sobre mueble abierto, plancha cm.56x51 (incluida 1 Chapa de cierre para top mod.TPA-7)
cm. 60x 70,5x 90h



⚡ 7,4 kW **2.751,00**
400V~3N 78 / 0,54
50/60 Hz



FTR-76ETS
08060636

FRY-TOP ELETTRICO RIGATO CROMATO SUPERCHROME (MOCA APPROVED), SU MOBILE A GIORNO, PIASTRA CM.56X51 (INCLUSA 1 TESTATA CHIUSURA PIANO MOD.TPA-7)

EN Electric Fry-top grooved chromed griddle SUPERCHROME (Moca Approved), on open cabinet, plate cm.56x51 (included 1 Head end filler strip mod.TPA-7) • **DE** Griddleplatte elektrische gerillt hartverchromt SUPERCHROME (Moca Approved), mit offenem Unterbau, platte cm.56x51 (inbegriffen 1 Abschluss-Element mod.TPA-7) • **FR** Plaque électriques nervurée chromée SUPERCHROME (Moca Approved), sur armoire ouvert, plaque cm.56x51 (inclus 1 Élément de jonction top mod.TPA-7) • **ES** Fry-top eléctrico estriado cromado SUPERCHROME (Moca Approved), sobre mueble abierto, plancha cm.56x51 (incluida 1 Chapa de cierre para top mod.TPA-7)
cm. 60x 70,5x 90h

⚡ 7,4 kW **3.281,00**
400V~3N 78 / 0,54
50/60 Hz



FTL-78ET
08060831

FRY-TOP ELETTRICO LISCIO, SU MOBILE A GIORNO, PIASTRA CM.76X51 - 2 ZONE DI COTTURA (INCLUSA 1 TESTATA CHIUSURA PIANO MOD.TPA-7)

EN Electric Fry-top smooth griddle, on open cabinet, plate cm.76x51 - 2 cooking areas (included 1 Head end filler strip mod.TPA-7) • **DE** Griddleplatte elektrische glatt, mit offenem Unterbau, platte cm.76x51 - 2 Heizzonen (inbegriffen 1 Abschluss-Element mod.TPA-7) • **FR** Plaque électriques lisse, sur armoire ouvert, plaque cm.76x51 - 2 zones de cuisson (inclus 1 Élément de jonction top mod.TPA-7) • **ES** Fry-top eléctrico liso, sobre mueble abierto, plancha cm.76x51 - 2 zonas de cocción (incluida 1 Chapa de cierre para top mod.TPA-7)
cm. 80x 70,5x 90h



⚡ 11,1 kW **3.195,00**
400V~3N 110 / 0,71
230V~3
50/60 Hz

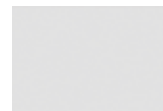

MOD. _____
COD. _____

DESCRIZIONE/DESCRIPTION/BEZEICHNUNG/DESCRIPTION/DESCRIPCIÓN
DIMENSIONI/DIMENSIONS/ABMESSUNGEN/DIMENSIONS/DIMENSIONES

POTENZA/POWER/LEISTUNG/PUISSANCE/POTENCIA
VOLTAGGIO/VOLTAGE/SPANNUNG/VOLTAGE/VOLTAJE

⚡ kW
kcal/h

⚡ kW
V~
Hz

PREZZO/PRICE
PREIS/PRIX/PRECIO
KG / M³



FTL-78ETS
08060834

FRY-TOP ELETTRICO LISCIO CROMATO SUPERCHROME (MOCA APPROVED), SU MOBILE A GIORNO, PIASTRA CM.76X51 - 2 ZONE DI COTTURA (INCLUSA 1 TESTATA CHIUSURA PIANO MOD.TPA-7)

EN Electric Fry-top smooth chromed griddle SUPERCHROME (Moca Approved), on open cabinet, plate cm.76x51 - 2 cooking areas (included 1 Head end filler strip mod.TPA-7) • **DE** Griddleplatte elektrische glatt hartverchromt SUPERCHROME (Moca Approved), mit offenem Unterbau, platte cm.76x51 - 2 Heizzonen (inbegriffen 1 Abschluss-Element mod.TPA-7) • **FR** Plaque électriques lisse chromée SUPERCHROME (Moca Approved), sur armoire ouvert, plaque cm.76x51 - 2 zones de cuisson (inclus 1 Élément de jonction top mod.TPA-7) • **ES** Fry-top eléctrico liso cromado SUPERCHROME (Moca Approved), sobre mueble abierto, plancha cm.76x51 - 2 zonas de cocción (incluida 1 Chapa de cierre para top mod.TPA-7)

cm. 80x 70,5x 90h



⚡ 11,1 kW
400V~3N
230V~3
50/60 Hz

3.802,00
110 / 0,71



FTL-78ETSS
08060830

FRY-TOP ELETTRICO LISCIO CROMO LUCIDO, SU MOBILE A GIORNO, PIASTRA CM.76X51 - 2 ZONE DI COTTURA (INCLUSA 1 TESTATA CHIUSURA PIANO MOD.TPA-7)

EN Electric Fry-top smooth POLISHED CHROME, on open cabinet, plate cm.76x51 - 2 cooking areas (included 1 Head end filler strip mod.TPA-7) • **DE** Griddleplatte elektrische glatt POLIERTEM CHROM, mit offenem Unterbau, platte cm.76x51 - 2 Heizzonen (inbegriffen 1 Abschluss-Element mod.TPA-7) • **FR** Plaque électriques lisse CHROME POLI, sur armoire ouvert, plaque cm.76x51 - 2 zones de cuisson (inclus 1 Élément de jonction top mod.TPA-7) • **ES** Fry-top eléctrico liso CROMO PULIDO, sobre mueble abierto, plancha cm.76x51 - 2 zonas de cocción (incluida 1 Chapa de cierre para top mod.TPA-7)

cm. 80x 70,5x 90h

⚡ 11,1 kW
400V~3N
230V~3
50/60 Hz

3.802,00
110 / 0,71



FTLR-78ET
08060832

FRY-TOP ELETTRICO 1/2 RIGATO + 1/2 LISCIO, SU MOBILE A GIORNO, PIASTRA CM.76X51 - 2 ZONE DI COTTURA (INCLUSA 1 TESTATA CHIUSURA PIANO MOD.TPA-7)

EN Electric Fry-top 1/2 grooved + 1/2 smooth, on open cabinet, plate cm.76x51 - 2 cooking areas (included 1 Head end filler strip mod.TPA-7) • **DE** Griddleplatte elektrische 1/2 gerillt + 1/2 glatt, mit offenem Unterbau, platte cm.76x51 - 2 Heizzonen (inbegriffen 1 Abschluss-Element mod.TPA-7) • **FR** Plaque électriques 1/2 nervurée + 1/2 lisse, sur armoire ouvert, plaque cm.76x51 - 2 zones de cuisson (inclus 1 Élément de jonction top mod.TPA-7) • **ES** Fry-top eléctrico 1/2 estriado + 1/2 liso, sobre mueble abierto, plancha cm.76x51 - 2 zonas de cocción (incluida 1 Chapa de cierre para top mod.TPA-7)

cm. 80x 70,5x 90h



⚡ 11,1 kW
400V~3N
230V~3
50/60 Hz

3.383,00
110 / 0,71



FTLR-78ETS
08060835

FRY-TOP ELETTRICO 1/2 RIGATO + 1/2 LISCIO CROMATO SUPERCHROME (MOCA APPROVED), SU MOBILE A GIORNO, PIASTRA CM.76X51 - 2 ZONE DI COTTURA (INCLUSA 1 TESTATA CHIUSURA PIANO MOD.TPA-7)

EN Electric Fry-top 1/2 grooved + 1/2 smooth chromed griddle SUPERCHROME (Moca Approved), on open cabinet, plate cm.76x51 - 2 cooking areas (included 1 Head end filler strip mod.TPA-7) • **DE** Griddleplatte elektrische 1/2 gerillt + 1/2 glatt hartverchromt SUPERCHROME (Moca Approved), mit offenem Unterbau, platte cm.76x51 - 2 Heizzonen (inbegriffen 1 Abschluss-Element mod.TPA-7) • **FR** Plaque électriques 1/2 nervurée + 1/2 lisse chromée SUPERCHROME (Moca Approved), sur armoire ouvert, plaque cm.76x51 - 2 zones de cuisson (inclus 1 Élément de jonction top mod.TPA-7) • **ES** Fry-top eléctrico 1/2 estriado + 1/2 liso cromado SUPERCHROME (Moca Approved), sobre mueble abierto, plancha cm.76x51 - 2 zonas de cocción (incluida 1 Chapa de cierre para top mod.TPA-7)

cm. 80x 70,5x 90h

⚡ 11,1 kW
400V~3N
230V~3
50/60 Hz

3.958,00
110 / 0,71



FRY-TOP ELETTRICI

MOD. _____
COD. _____

DESCRIZIONE/DESCRIPTION/BEZEICHNUNG/DESCRIPTION/DESCRIPCIÓN
DIMENSIONI/DIMENSIONS/ABMESSUNGEN/DIMENSIONS/DIMENSIONES

POTENZA/POWER/LEISTUNG/PUISSANCE/POTENCIA
VOLTAGGIO/VOLTAGE/SPANNUNG/VOLTAGE/VOLTAJE

⚡ kW _____
kcal/h _____
V~ _____
Hz _____

PREZZO/PRICE
PREIS/PRIX/PRECIO
KG / M³



FTR-78ET
08060833

FRY-TOP ELETTRICO RIGATO, SU MOBILE A GIORNO, PIASTRA CM.76X51 - 2 ZONE DI COTTURA (INCLUSA 1 TESTATA CHIUSURA PIANO MOD.TPA-7)

EN Electric Fry-top grooved griddle, on open cabinet, plate cm.76x51 - 2 cooking areas (included 1 Head end filler strip mod.TPA-7) • **DE** Griddleplatte elektrische gerillt, mit offenem Unterbau, platte cm.76x51 - 2 Heizzonen (inbegriffen 1 Abschluss-Element mod.TPA-7) • **FR** Plaque électriques nervurée, sur armoire ouvert, plaque cm.76x51 - 2 zones de cuisson (inclus 1 Élément de jonction top mod.TPA-7) • **ES** Fry-top eléctrico estriado, sobre mueble abierto, plancha cm.76x51 - 2 zonas de cocción (incluida 1 Chapa de cierre para top mod.TPA-7)
cm. 80x 70,5x 90h



⚡ 11,1 kW _____ **3.463,00**
400V~3N _____ 110 / 0,71
230V~3 _____
50/60 Hz _____



FTR-78ETS
08060836

FRY-TOP ELETTRICO RIGATO CROMATO SUPERCHROME (MOCA APPROVED), SU MOBILE A GIORNO, PIASTRA CM.76X51 - 2 ZONE DI COTTURA (INCLUSA 1 TESTATA CHIUSURA PIANO MOD.TPA-7)

EN Electric Fry-top grooved chromed griddle SUPERCHROME (Moca Approved), on open cabinet, plate cm.76x51 - 2 cooking areas (included 1 Head end filler strip mod.TPA-7) • **DE** Griddleplatte elektrische gerillt hartverchromt SUPERCHROME (Moca Approved), mit offenem Unterbau, platte cm.76x51 - 2 Heizzonen (inbegriffen 1 Abschluss-Element mod.TPA-7) • **FR** Plaque électriques nervurée chromée SUPERCHROME (Moca Approved), sur armoire ouvert, plaque cm.76x51 - 2 zones de cuisson (inclus 1 Élément de jonction top mod.TPA-7) • **ES** Fry-top eléctrico estriado cromado SUPERCHROME (Moca Approved), sobre mueble abierto, plancha cm.76x51 - 2 zonas de cocción (incluida 1 Chapa de cierre para top mod.TPA-7)
cm. 80x 70,5x 90h

⚡ 11,1 kW _____ **4.126,00**
400V~3N _____ 110 / 0,71
230V~3 _____
50/60 Hz _____



FTL-712ET
08061231

FRY-TOP ELETTRICO LISCIO, SU MOBILE A GIORNO, PIASTRA CM.116X51 - 2 ZONE DI COTTURA (INCLUSA 1 TESTATA CHIUSURA PIANO MOD.TPA-7)

EN Electric Fry-top smooth griddle, on open cabinet, plate cm.116x51 - 2 cooking areas (included 1 Head end filler strip mod.TPA-7) • **DE** Griddleplatte elektrische glatt, mit offenem Unterbau, platte cm.116x51 - 2 Heizzonen (inbegriffen 1 Abschluss-Element mod.TPA-7) • **FR** Plaque électriques lisse, sur armoire ouvert, plaque cm.116x51 - 2 zones de cuisson (inclus 1 Élément de jonction top mod.TPA-7) • **ES** Fry-top eléctrico liso, sobre mueble abierto, plancha cm.116x51 - 2 zonas de cocción (incluida 1 Chapa de cierre para top mod.TPA-7)
cm. 120x 70,5x 90h



⚡ 14,8 kW _____ **4.062,00**
400V~3N _____ 150 / 1,05
50/60 Hz _____

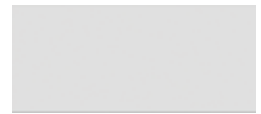

FTL-712ETS
08061234

FRY-TOP ELETTRICO LISCIO CROMATO SUPERCHROME (MOCA APPROVED), SU MOBILE A GIORNO, PIASTRA CM.116X51 - 2 ZONE DI COTTURA (INCLUSA 1 TESTATA CHIUSURA PIANO MOD.TPA-7)

EN Electric Fry-top smooth chromed griddle SUPERCHROME (Moca Approved), on open cabinet, plate cm.116x51 - 2 cooking areas (included 1 Head end filler strip mod.TPA-7) • **DE** Griddleplatte elektrische glatt hartverchromt SUPERCHROME (Moca Approved), mit offenem Unterbau, platte cm.116x51 - 2 Heizzonen (inbegriffen 1 Abschluss-Element mod.TPA-7) • **FR** Plaque électriques lisse chromée SUPERCHROME (Moca Approved), sur armoire ouvert, plaque cm.116x51 - 2 zones de cuisson (inclus 1 Élément de jonction top mod.TPA-7) • **ES** Fry-top eléctrico liso cromado SUPERCHROME (Moca Approved), sobre mueble abierto, plancha cm.116x51 - 2 zonas de cocción (incluida 1 Chapa de cierre para top mod.TPA-7)
cm. 120x 70,5x 90h

⚡ 14,8 kW _____ **4.994,00**
400V~3N _____ 150 / 1,05
50/60 Hz _____

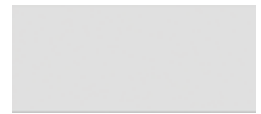

MOD. _____
COD. _____

DESCRIZIONE/DESCRIPTION/BEZEICHNUNG/DESCRIPTION/DESCRIPCIÓN
DIMENSIONI/DIMENSIONS/ABMESSUNGEN/DIMENSIONS/DIMENSIONES

POTENZA/POWER/LEISTUNG/PUISSANCE/POTENCIA
VOLTAGGIO/VOLTAGE/SPANNUNG/VOLTAGE/VOLTAJE

⚡ kW kcal/h
⚡ kW V~ Hz

PREZZO/PRICE
PREIS/PRIX/PRECIO
KG / M³



FTLR-712ET FRY-TOP ELETTRICO 1/2 RIGATO + 1/2 LISCIO, SU MOBILE A GIORNO, PIASTRA CM.116X51 - 2 ZONE DI COTTURA (INCLUSA 1 TESTATA CHIUSURA PIANO MOD.TPA-7)

08061232

EN Electric Fry-top 1/2 grooved + 1/2 smooth, on open cabinet, plate cm.116x51 - 2 cooking areas (included 1 Head end filler strip mod. TPA-7) • **DE** Griddleplatte elektrische 1/2 gerillt + 1/2 glatt, mit offenem Unterbau, platte cm.116x51 - 2 Heizzonen (inbegriffen 1 Abschluss-Element mod.TPA-7) • **FR** Plaque électriques 1/2 nervurée + 1/2 lisse, sur armoire ouvert, plaque cm.116x51 - 2 zones de cuisson (inclus 1 Élément de jonction top mod.TPA-7) • **ES** Fry-top eléctrico 1/2 estriado + 1/2 liso, sobre mueble abierto, plancha cm.116x51 - 2 zonas de cocción (incluida 1 Chapa de cierre para top mod.TPA-7)
cm. 120x 70,5x 90h



⚡ 14,8 kW **4.250,00**
400V~3N 150 / 1,05
50/60 Hz



FTLR-712ETS FRY-TOP ELETTRICO 1/2 RIGATO + 1/2 LISCIO CROMATO SUPERCHROME (MOCA APPROVED), SU MOBILE A GIORNO, PIASTRA CM.116X51 - 2 ZONE DI COTTURA (INCLUSA 1 TESTATA CHIUSURA PIANO MOD.TPA-7)

08061235

EN Electric Fry-top 1/2 grooved + 1/2 smooth chromed griddle SUPERCHROME (Moca Approved), on open cabinet, plate cm.116x51 - 2 cooking areas (included 1 Head end filler strip mod.TPA-7) • **DE** Griddleplatte elektrische 1/2 gerillt + 1/2 glatt hartverchromt SUPERCHROME (Moca Approved), mit offenem Unterbau, platte cm.116x51 - 2 Heizzonen (inbegriffen 1 Abschluss-Element mod. TPA-7) • **FR** Plaque électriques 1/2 nervurée + 1/2 lisse chromée SUPERCHROME (Moca Approved), sur armoire ouvert, plaque cm.116x51 - 2 zones de cuisson (inclus 1 Élément de jonction top mod.TPA-7) • **ES** Fry-top eléctrico 1/2 estriado + 1/2 liso cromado SUPERCHROME (Moca Approved), sobre mueble abierto, plancha cm.116x51 - 2 zonas de cocción (incluida 1 Chapa de cierre para top mod.TPA-7)
cm. 120x 70,5x 90h

⚡ 14,8 kW **5.279,00**
400V~3N 150 / 1,05
50/60 Hz



FTR-712ET FRY-TOP ELETTRICO RIGATO, SU MOBILE A GIORNO, PIASTRA CM.116X51 - 2 ZONE DI COTTURA (INCLUSA 1 TESTATA CHIUSURA PIANO MOD.TPA-7)

08061233

EN Electric Fry-top grooved griddle, on open cabinet, plate cm.116x51 - 2 cooking areas (included 1 Head end filler strip mod.TPA-7) • **DE** Griddleplatte elektrische gerillt, mit offenem Unterbau, platte cm.116x51 - 2 Heizzonen (inbegriffen 1 Abschluss-Element mod.TPA-7) • **FR** Plaque électriques nervurée, sur armoire ouvert, plaque cm.116x51 - 2 zones de cuisson (inclus 1 Élément de jonction top mod.TPA-7) • **ES** Fry-top eléctrico estriado, sobre mueble abierto, plancha cm.116x51 - 2 zonas de cocción (incluida 1 Chapa de cierre para top mod.TPA-7)
cm. 120x 70,5x 90h

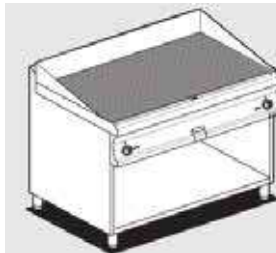

⚡ 14,8 kW **4.448,00**
400V~3N 150 / 1,05
50/60 Hz



FTR-712ETS FRY-TOP ELETTRICO RIGATO CROMATO SUPERCHROME (MOCA APPROVED), SU MOBILE A GIORNO, PIASTRA CM.116X51 - 2 ZONE DI COTTURA (INCLUSA 1 TESTATA CHIUSURA PIANO MOD.TPA-7)

08061236

EN Electric Fry-top grooved chromed griddle SUPERCHROME (Moca Approved), on open cabinet, plate cm.116x51 - 2 cooking areas (included 1 Head end filler strip mod.TPA-7) • **DE** Griddleplatte elektrische gerillt hartverchromt SUPERCHROME (Moca Approved), mit offenem Unterbau, platte cm.116x51 - 2 Heizzonen (inbegriffen 1 Abschluss-Element mod. TPA-7) • **FR** Plaque électriques nervurée chromée SUPERCHROME (Moca Approved), sur armoire ouvert, plaque cm.116x51 - 2 zones de cuisson (inclus 1 Élément de jonction top mod.TPA-7) • **ES** Fry-top eléctrico estriado cromado SUPERCHROME (Moca Approved), sobre mueble abierto, plancha cm.116x51 - 2 zonas de cocción (incluida 1 Chapa de cierre para top mod.TPA-7)
cm. 120x 70,5x 90h

⚡ 14,8 kW **5.647,00**
400V~3N 150 / 1,05
50/60 Hz



FRY-TOP ELETTRICI

MOD. _____
COD. _____

DESCRIZIONE/DESCRIPTION/BEZEICHNUNG/DESCRIPTION/DESCRIPCIÓN
DIMENSIONI/DIMENSIONS/ABMESSUNGEN/DIMENSIONS/DIMENSIONES

POTENZA/POWER/LEISTUNG/PUISSANCE/POTENCIA
VOLTAGGIO/VOLTAGE/SPANNUNG/VOLTAGE/VOLTAJE

$\frac{kW}{kcal/h}$ $\frac{kW}{V \sim}$
Hz

PREZZO/PRICE
PREIS/PRIX/PRECIO
KG / M³



FTL-712ET3
0806123B

FRY-TOP ELETTRICO LISCIO, SU MOBILE A GIORNO, PIASTRA CM.116X51 - 3 ZONE DI COTTURA (INCLUSA 1 TESTATA CHIUSURA PIANO MOD.TPA-7)

EN Electric Fry-top smooth griddle, on open cabinet, plate cm.116x51 - 3 cooking areas (included 1 Head end filler strip mod.TPA-7) • **DE** Griddleplatte elektrische glatt, mit offenem Unterbau, platte cm.116x51 - 3 Heizzonen (inbegriffen 1 Abschluss-Element mod.TPA-7) • **FR** Plaque électriques lisse, sur armoire ouvert, plaque cm.116x51 - 3 zones de cuisson (inclus 1 Élément de jonction top mod.TPA-7) • **ES** Fry-top eléctrico liso, sobre mueble abierto, plancha cm.116x51 - 3 zonas de cocción (incluida 1 Chapa de cierre para top mod.TPA-7)
cm. 120x 70,5x 90h



$\frac{16,65 kW}{400V \sim 3N}$ **4.448,00**
 $\frac{150}{50/60 Hz}$ / 1,05

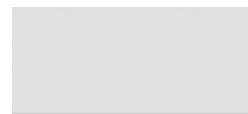

FTL-712ETS3
0806123E

FRY-TOP ELETTRICO LISCIO CROMATO SUPERCHROME (MOCA APPROVED), SU MOBILE A GIORNO, PIASTRA CM.116X51 - 3 ZONE DI COTTURA (INCLUSA 1 TESTATA CHIUSURA PIANO MOD.TPA-7)

EN Electric Fry-top smooth chromed griddle SUPERCHROME (Moca Approved), on open cabinet, plate cm.116x51 - 3 cooking areas (included 1 Head end filler strip mod.TPA-7) • **DE** Griddleplatte elektrische glatt hartverchromt SUPERCHROME (Moca Approved), mit offenem Unterbau, platte cm.116x51 - 3 Heizzonen (inbegriffen 1 Abschluss-Element mod.TPA-7) • **FR** Plaque électriques lisse chromée SUPERCHROME (Moca Approved), sur armoire ouvert, plaque cm.116x51 - 3 zones de cuisson (inclus 1 Élément de jonction top mod.TPA-7) • **ES** Fry-top eléctrico liso cromado SUPERCHROME (Moca Approved), sobre mueble abierto, plancha cm.116x51 - 3 zonas de cocción (incluida 1 Chapa de cierre para top mod.TPA-7)
cm. 120x 70,5x 90h

$\frac{16,65 kW}{400V \sim 3N}$ **5.336,00**
 $\frac{150}{50/60 Hz}$ / 1,05

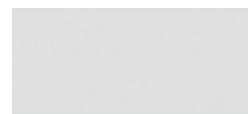

FTL-712ETSS3
0806123Y

FRY-TOP ELETTRICO LISCIO CROMO LUCIDO, SU MOBILE A GIORNO, PIASTRA CM.116X51 - 3 ZONE DI COTTURA (INCLUSA 1 TESTATA CHIUSURA PIANO MOD.TPA-7)

EN Electric Fry-top smooth POLISHED CHROME, on open cabinet, plate cm.116x51 - 3 cooking areas (included 1 Head end filler strip mod.TPA-7) • **DE** Griddleplatte elektrische glatt POLIERTEM CHROM, mit offenem Unterbau, platte cm.116x51 - 3 Heizzonen (inbegriffen 1 Abschluss-Element mod.TPA-7) • **FR** Plaque électriques lisse CHROME POLI, sur armoire ouvert, plaque cm.116x51 - 3 zones de cuisson (inclus 1 Élément de jonction top mod.TPA-7) • **ES** Fry-top eléctrico liso CROMO PULIDO, sobre mueble abierto, plancha cm.116x51 - 3 zonas de cocción (incluida 1 Chapa de cierre para top mod.TPA-7)
cm. 120x 70,5x 90h

$\frac{16,65 kW}{400V \sim 3N}$ **5.336,00**
 $\frac{150}{50/60 Hz}$ / 1,05



FTLR-712ET3
0806123C

FRY-TOP ELETTRICO 1/3 RIGATO + 2/3 LISCIO, SU MOBILE A GIORNO, PIASTRA CM.116X51 - 3 ZONE DI COTTURA (INCLUSA 1 TESTATA CHIUSURA PIANO MOD.TPA-7)

EN Electric Fry-top 1/3 grooved + 2/3 smooth, on open cabinet, plate cm.116x51 - 3 cooking areas (included 1 Head end filler strip mod.TPA-7) • **DE** Griddleplatte elektrische 1/3 gerillt + 2/3 glatt, mit offenem Unterbau, platte cm.116x51 - 3 Heizzonen (inbegriffen 1 Abschluss-Element mod.TPA-7) • **FR** Plaque électriques 1/3 nervurée + 2/3 lisse, sur armoire ouvert, plaque cm.116x51 - 3 zones de cuisson (inclus 1 Élément de jonction top mod.TPA-7) • **ES** Fry-top eléctrico 1/3 estriado + 2/3 liso, sobre mueble abierto, plancha cm.116x51 - 3 zonas de cocción (incluida 1 Chapa de cierre para top mod.TPA-7)
cm. 120x 70,5x 90h



$\frac{16,65 kW}{400V \sim 3N}$ **4.567,00**
 $\frac{150}{50/60 Hz}$ / 1,05



MOD. _____
COD. _____

DESCRIZIONE/DESCRIPTION/BEZEICHNUNG/DESCRIPTION/DESCRIPCIÓN
DIMENSIONI/DIMENSIONS/ABMESSUNGEN/DIMENSIONS/DIMENSIONES

POTENZA/POWER/LEISTUNG/PUISSANCE/POTENCIA
VOLTAGGIO/VOLTAGE/SPANNUNG/VOLTAGE/VOLTAJE

⚡ kW kcal/h
⚡ kw V~ Hz

PREZZO/PRICE
PREIS/PRIX/PRECIO
KG / M³



FTLR-712ETS3 FRY-TOP ELETTRICO 1/3 RIGATO + 2/3 LISCIO CROMATO SUPERCHROME (MOCA APPROVED), SU MOBILE A GIORNO, PIASTRA CM.116X51 - 3 ZONE DI COTTURA (INCLUSA 1 TESTATA CHIUSURA PIANO MOD.TPA-7)

0806123F

EN Electric Fry-top 1/3 grooved + 2/3 smooth chromed griddle SUPERCHROME (Moca Approved), on open cabinet, plate cm.116x51 - 3 cooking areas (included 1 Head end filler strip mod.TPA-7)
• DE Griddleplatte elektrische 1/3 gerillt + 2/3 glatt hartverchromt SUPERCHROME (Moca Approved), mit offenem Unterbau, platte cm.116x51 - 3 Heizzonen (inbegriffen 1 Abschluss-Element mod.TPA-7)
• FR Plaque électriques 1/3 nervurée + 2/3 lisse chromée SUPERCHROME (Moca Approved), sur armoire ouvert, plaque cm.116x51 - 3 zones de cuisson (inclus 1 Élément de jonction top mod.TPA-7)
• ES Fry-top eléctrico 1/3 estriado + 2/3 liso cromado SUPERCHROME (Moca Approved), sobre mueble abierto, plancha cm.116x51 - 3 zonas de cocción (incluida 1 Chapa de cierre para top mod.TPA-7)
cm. 120x 70,5x 90h



⚡ 16,65 kW 5.463,00
400V~3N 150 / 1,05
50/60 Hz



FTL-74G FRY-TOP GAS LISCIO, SU MOBILE A GIORNO, PIASTRA CM.36X51 (INCLUSA 1 TESTATA CHIUSURA PIANO MOD.TPA-7)

08230451

EN Gas Fry-top smooth griddle, on open cabinet, plate cm.36x51 (included 1 Head end filler strip mod.TPA-7)
• DE Gas-griddleplatte glatt, mit offenem Unterbau, platte cm.36x51 (inbegriffen 1 Abschluss-Element mod.TPA-7)
• FR Plaque gaz lisse, sur armoire ouvert, plaque cm.36x51 (inclus 1 Élément de jonction top mod.TPA-7)
• ES Fry-top gas liso, sobre mueble abierto, plancha cm.36x51 (incluida 1 Chapa de cierre para top mod.TPA-7)
cm. 40x 70,5x 90h



⚡ 7 kW 2.243,00
6.020 kcal/h 69 / 0,37



FTL-74GS FRY-TOP GAS LISCIO CROMATO SUPERCHROME (MOCA APPROVED), SU MOBILE A GIORNO, PIASTRA CM.36X51 (INCLUSA 1 TESTATA CHIUSURA PIANO MOD.TPA-7)

08230454

EN Gas Fry-top smooth chromed griddle SUPERCHROME (Moca Approved), on open cabinet, plate cm.36x51 (included 1 Head end filler strip mod.TPA-7)
• DE Gas-griddleplatte glatt hartverchromt SUPERCHROME (Moca Approved), mit offenem Unterbau, platte cm.36x51 (inbegriffen 1 Abschluss-Element mod.TPA-7)
• FR Plaque gaz lisse chromée SUPERCHROME (Moca Approved), sur armoire ouvert, plaque cm.36x51 (inclus 1 Élément de jonction top mod.TPA-7)
• ES Fry-top gas liso cromado SUPERCHROME (Moca Approved), sobre mueble abierto, plancha cm.36x51 (incluida 1 Chapa de cierre para top mod.TPA-7)
cm. 40x 70,5x 90h

⚡ 7 kW 2.656,00
6.020 kcal/h 69 / 0,37



FTL-74GSS FRY-TOP GAS LISCIO CROMO LUCIDO, SU MOBILE A GIORNO, PIASTRA CM.36X51 (INCLUSA 1 TESTATA CHIUSURA PIANO MOD.TPA-7)

08230450

EN Gas Fry-top smooth POLISHED CHROME, on open cabinet, plate cm.36x51 (included 1 Head end filler strip mod.TPA-7)
• DE Gas-griddleplatte glatt POLIERTEM CHROM, mit offenem Unterbau, platte cm.36x51 (inbegriffen 1 Abschluss-Element mod.TPA-7)
• FR Plaque gaz lisse CHROME POLI, sur armoire ouvert, plaque cm.36x51 (inclus 1 Élément de jonction top mod.TPA-7)
• ES Fry-top gas liso CROMO PULIDO, sobre mueble abierto, plancha cm.36x51 (incluida 1 Chapa de cierre para top mod.TPA-7)
cm. 40x 70,5x 90h

⚡ 7 kW 2.656,00
6.020 kcal/h 69 / 0,37



FTR-74G FRY-TOP GAS RIGATO, SU MOBILE A GIORNO, PIASTRA CM.36X51 (INCLUSA 1 TESTATA CHIUSURA PIANO MOD.TPA-7)

08230453

EN Gas Fry-top grooved griddle, on open cabinet, plate cm.36x51 (included 1 Head end filler strip mod.TPA-7)
• DE Gas-griddleplatte gerillt, mit offenem Unterbau, platte cm.36x51 (inbegriffen 1 Abschluss-Element mod.TPA-7)
• FR Plaque gaz nervurée, sur armoire ouvert, plaque cm.36x51 (inclus 1 Élément de jonction top mod.TPA-7)
• ES Fry-top gas estriado, sobre mueble abierto, plancha cm.36x51 (incluida 1 Chapa de cierre para top mod.TPA-7)
cm. 40x 70,5x 90h

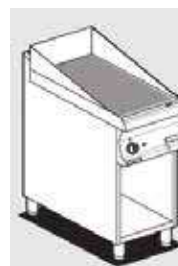

⚡ 7 kW 2.404,00
6.020 kcal/h 69 / 0,37



FRY-TOP A GAS

MOD. _____
COD. _____

DESCRIZIONE/DESCRIPTION/BEZEICHNUNG/DESCRIPTION/DESCRIPCIÓN
DIMENSIONI/DIMENSIONS/ABMESSUNGEN/DIMENSIONS/DIMENSIONES

POTENZA/POWER/LEISTUNG/PUISSANCE/POTENCIA
VOLTAGGIO/VOLTAGE/SPANNUNG/VOLTAGE/VOLTAJE

⚡ kW
kcal/h

⚡ kW
V~
Hz

PREZZO/PRICE
PREIS/PRIX/PRECIO
KG / M³



FTR-74GS
08230456

FRY-TOP GAS RIGATO CROMATO SUPERCHROME (MOCA APPROVED), SU MOBILE A GIORNO, PIASTRA CM.36X51 (INCLUSA 1 TESTATA CHIUSURA PIANO MOD.TPA-7)

EN Gas Fry-top grooved chromed griddle SUPERCHROME (Moca Approved), on open cabinet, plate cm.36x51 (included 1 Head end filler strip mod.TPA-7) • **DE** Gas-griddleplatte gerillt hartverchromt SUPERCHROME (Moca Approved), mit offenem Unterbau, platte cm.36x51 (inbegriffen 1 Abschluss-Element mod.TPA-7) • **FR** Plaque gaz nervurée chromée SUPERCHROME (Moca Approved), sur armoire ouvert, plaque cm.36x51 (inclus 1 Élément de jonction top mod.TPA-7) • **ES** Fry-top gas estriado cromado SUPERCHROME (Moca Approved), sobre mueble abierto, plancha cm.36x51 (incluida 1 Chapa de cierre para top mod.TPA-7)

cm. 40x 70,5x 90h

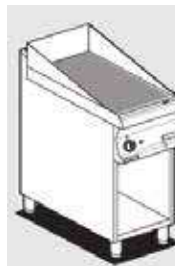

⚡ 7 kW
6.020 kcal/h

2.811,00
69 / 0,37



FTL-76G
08230651

FRY-TOP GAS LISCIO, SU MOBILE A GIORNO, PIASTRA CM.56X51 (INCLUSA 1 TESTATA CHIUSURA PIANO MOD.TPA-7)

EN Gas Fry-top smooth griddle, on open cabinet, plate cm.56x51 (included 1 Head end filler strip mod.TPA-7) • **DE** Gas-griddleplatte glatt, mit offenem Unterbau, platte cm.56x51 (inbegriffen 1 Abschluss-Element mod.TPA-7) • **FR** Plaque gaz lisse, sur armoire ouvert, plaque cm.56x51 (inclus 1 Élément de jonction top mod.TPA-7) • **ES** Fry-top gas liso, sobre mueble abierto, plancha cm.56x51 (incluida 1 Chapa de cierre para top mod.TPA-7)

cm. 60x 70,5x 90h



⚡ 10,5 kW
9.030 kcal/h

2.625,00
83 / 0,54

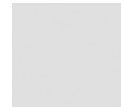

FTL-76GS
08230654

FRY-TOP GAS LISCIO CROMATO SUPERCHROME (MOCA APPROVED), SU MOBILE A GIORNO, PIASTRA CM.56X51 (INCLUSA 1 TESTATA CHIUSURA PIANO MOD.TPA-7)

EN Gas Fry-top smooth chromed griddle SUPERCHROME (Moca Approved), on open cabinet, plate cm.56x51 (included 1 Head end filler strip mod.TPA-7) • **DE** Gas-griddleplatte glatt hartverchromt SUPERCHROME (Moca Approved), mit offenem Unterbau, platte cm.56x51 (inbegriffen 1 Abschluss-Element mod.TPA-7) • **FR** Plaque gaz lisse chromée SUPERCHROME (Moca Approved), sur armoire ouvert, plaque cm.56x51 (inclus 1 Élément de jonction top mod.TPA-7) • **ES** Fry-top gas liso cromado SUPERCHROME (Moca Approved), sobre mueble abierto, plancha cm.56x51 (incluida 1 Chapa de cierre para top mod.TPA-7)

cm. 60x 70,5x 90h

⚡ 10,5 kW
9.030 kcal/h

3.198,00
83 / 0,54

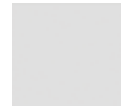

FTL-76GSS
08230650

FRY-TOP GAS LISCIO CROMO LUCIDO, SU MOBILE A GIORNO, PIASTRA CM.56X51 (INCLUSA 1 TESTATA CHIUSURA PIANO MOD.TPA-7)

EN Gas Fry-top smooth POLISHED CHROME, on open cabinet, plate cm.56x51 (included 1 Head end filler strip mod.TPA-7) • **DE** Gas-griddleplatte glatt POLIERTEM CHROM, mit offenem Unterbau, platte cm.56x51 (inbegriffen 1 Abschluss-Element mod.TPA-7) • **FR** Plaque gaz lisse CHROME POLI, sur armoire ouvert, plaque cm.56x51 (inclus 1 Élément de jonction top mod.TPA-7) • **ES** Fry-top gas liso CROMO PULIDO, sobre mueble abierto, plancha cm.56x51 (incluida 1 Chapa de cierre para top mod.TPA-7)

cm. 60x 70,5x 90h

⚡ 10,5 kW
9.030 kcal/h

3.198,00
83 / 0,54

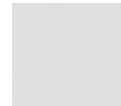

FTLR-76G
08230652

FRY-TOP GAS 1/2 RIGATO + 1/2 LISCIO, SU MOBILE A GIORNO, PIASTRA CM.56X51 (INCLUSA 1 TESTATA CHIUSURA PIANO MOD.TPA-7)

EN Gas Fry-top 1/2 grooved + 1/2 smooth, on open cabinet, plate cm.56x51 (included 1 Head end filler strip mod.TPA-7) • **DE** Gas-griddleplatte 1/2 gerillt + 1/2 glatt, mit offenem Unterbau, platte cm.56x51 (inbegriffen 1 Abschluss-Element mod.TPA-7) • **FR** Plaque gaz 1/2 nervurée + 1/2 lisse, sur armoire ouvert, plaque cm.56x51 (inclus 1 Élément de jonction top mod.TPA-7) • **ES** Fry-top gas 1/2 estriado + 1/2 liso, sobre mueble abierto, plancha cm.56x51 (incluida 1 Chapa de cierre para top mod.TPA-7)

cm. 60x 70,5x 90h



⚡ 10,5 kW
9.030 kcal/h

2.754,00
83 / 0,54



MOD. _____
COD. _____

DESCRIZIONE/DESCRIPTION/BEZEICHNUNG/DESCRIPTION/DESCRIPCIÓN
DIMENSIONI/DIMENSIONS/ABMESSUNGEN/DIMENSIONS/DIMENSIONES

POTENZA/POWER/LEISTUNG/PUISSANCE/POTENCIA
VOLTAGGIO/VOLTAGE/SPANNUNG/VOLTAGE/VOLTAJE

⚡ kW
9.030 kcal/h

PREZZO/PRICE
PREIS/PRIX/PRECIO
KG / M³



FTLR-76GS
08230655

FRY-TOP GAS 1/2 RIGATO + 1/2 LISCIO CROMATO SUPERCHROME (MOCA APPROVED), SU MOBILE A GIORNO, PIASTRA CM.56X51 (INCLUSA 1 TESTATA CHIUSURA PIANO MOD.TPA-7)

EN Gas Fry-top 1/2 grooved + 1/2 smooth chromed griddle SUPERCHROME (Moca Approved), on open cabinet, plate cm.56x51 (included 1 Head end filler strip mod.TPA-7) • **DE** Gas-griddleplatte 1/2 gerillt + 1/2 glatt hartverchromt SUPERCHROME (Moca Approved), mit offenem Unterbau, platte cm.56x51 (inbegriffen 1 Abschluss-Element mod.TPA-7) • **FR** Plaque gaz 1/2 nervurée + 1/2 lisse chromée SUPERCHROME (Moca Approved), sur armoire ouvert, plaque cm.56x51 (inclus 1 Élément de jonction top mod.TPA-7) • **ES** Fry-top gas 1/2 estriado + 1/2 liso cromado SUPERCHROME (Moca Approved), sobre mueble abierto, plancha cm.56x51 (incluida 1 Chapa de cierre para top mod.TPA-7)

cm. 60x 70,5x 90h



⚡ 10,5 kW
9.030 kcal/h

3.331,00
83 / 0,54



FTR-76G
08230653

FRY-TOP GAS RIGATO, SU MOBILE A GIORNO, PIASTRA CM.56X51 (INCLUSA 1 TESTATA CHIUSURA PIANO MOD.TPA-7)

EN Gas Fry-top grooved griddle, on open cabinet, plate cm.56x51 (included 1 Head end filler strip mod.TPA-7) • **DE** Gas-griddleplatte gerillt, mit offenem Unterbau, platte cm.56x51 (inbegriffen 1 Abschluss-Element mod.TPA-7) • **FR** Plaque gaz nervurée, sur armoire ouvert, plaque cm.56x51 (inclus 1 Élément de jonction top mod.TPA-7) • **ES** Fry-top gas estriado, sobre mueble abierto, plancha cm.56x51 (incluida 1 Chapa de cierre para top mod.TPA-7)

cm. 60x 70,5x 90h

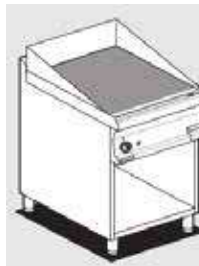

⚡ 10,5 kW
9.030 kcal/h

2.869,00
83 / 0,54



FTR-76GS
08230656

FRY-TOP GAS RIGATO CROMATO SUPERCHROME (MOCA APPROVED), SU MOBILE A GIORNO, PIASTRA CM.56X51 (INCLUSA 1 TESTATA CHIUSURA PIANO MOD.TPA-7)

EN Gas Fry-top grooved chromed griddle SUPERCHROME (Moca Approved), on open cabinet, plate cm.56x51 (included 1 Head end filler strip mod.TPA-7) • **DE** Gas-griddleplatte gerillt hartverchromt SUPERCHROME (Moca Approved), mit offenem Unterbau, platte cm.56x51 (inbegriffen 1 Abschluss-Element mod.TPA-7) • **FR** Plaque gaz nervurée chromée SUPERCHROME (Moca Approved), sur armoire ouvert, plaque cm.56x51 (inclus 1 Élément de jonction top mod.TPA-7) • **ES** Fry-top gas estriado cromado SUPERCHROME (Moca Approved), sobre mueble abierto, plancha cm.56x51 (incluida 1 Chapa de cierre para top mod.TPA-7)

cm. 60x 70,5x 90h

⚡ 10,5 kW
9.030 kcal/h

3.437,00
83 / 0,54



FTL-78G
08230851

FRY-TOP GAS LISCIO, SU MOBILE A GIORNO, PIASTRA CM.76X51 - 2 ZONE DI COTTURA (INCLUSA 1 TESTATA CHIUSURA PIANO MOD.TPA-7)

EN Gas Fry-top smooth griddle, on open cabinet, plate cm.76x51 - 2 cooking areas (included 1 Head end filler strip mod.TPA-7) • **DE** Gas-griddleplatte glatt, mit offenem Unterbau, platte cm.76x51 - 2 Heizzonen (inbegriffen 1 Abschluss-Element mod.TPA-7) • **FR** Plaque gaz lisse, sur armoire ouvert, plaque cm.76x51 - 2 zones de cuisson (inclus 1 Élément de jonction top mod.TPA-7) • **ES** Fry-top gas liso, sobre mueble abierto, plancha cm.76x51 - 2 zonas de cocción (incluida 1 Chapa de cierre para top mod.TPA-7)

cm. 80x 70,5x 90h



⚡ 14 kW
12.040 kcal/h

3.605,00
114 / 0,71

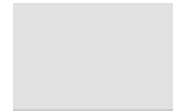

FTL-78GS
08230854

FRY-TOP GAS LISCIO CROMATO SUPERCHROME (MOCA APPROVED), SU MOBILE A GIORNO, PIASTRA CM.76X51 - 2 ZONE DI COTTURA (INCLUSA 1 TESTATA CHIUSURA PIANO MOD.TPA-7)

EN Gas Fry-top smooth chromed griddle SUPERCHROME (Moca Approved), on open cabinet, plate cm.76x51 - 2 cooking areas (included 1 Head end filler strip mod.TPA-7) • **DE** Gas-griddleplatte glatt hartverchromt SUPERCHROME (Moca Approved), mit offenem Unterbau, platte cm.76x51 - 2 Heizzonen (inbegriffen 1 Abschluss-Element mod.TPA-7) • **FR** Plaque gaz lisse chromée SUPERCHROME (Moca Approved), sur armoire ouvert, plaque cm.76x51 - 2 zones de cuisson (inclus 1 Élément de jonction top mod.TPA-7) • **ES** Fry-top gas liso cromado SUPERCHROME (Moca Approved), sobre mueble abierto, plancha cm.76x51 - 2 zonas de cocción (incluida 1 Chapa de cierre para top mod.TPA-7)

cm. 80x 70,5x 90h

⚡ 14 kW
12.040 kcal/h

4.255,00
114 / 0,71

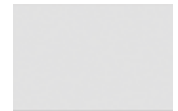

FRY-TOP A GAS

MOD. _____
COD. _____

DESCRIZIONE / DESCRIPTION / BEZEICHNUNG / DESCRIPTION / DESCRIPCIÓN
DIMENSIONI / DIMENSIONS / ABMESSUNGEN / DIMENSIONS / DIMENSIONES

POTENZA / POWER / LEISTUNG / PUISSANCE / POTENCIA
VOLTAGGIO / VOLTAGE / SPANNUNG / VOLTAGE / VOLTAJE

14 kW
12.040 kcal/h

PREZZO / PRICE
PREIS / PRIX / PRECIO
KG / M³



FTL-78GSS
08230850

FRY-TOP GAS LISCIO CROMO LUCIDO, SU MOBILE A GIORNO, PIASTRA CM.76X51 - 2 ZONE DI COTTURA (INCLUSA 1 TESTATA CHIUSURA PIANO MOD.TPA-7)

EN Gas Fry-top smooth POLISHED CHROME, on open cabinet, plate cm.76x51 - 2 cooking areas (included 1 Head end filler strip mod.TPA-7)
• **DE** Gas-griddleplatte glatt POLIERTEM CHROM, mit offenem Unterbau, platte cm.76x51 - 2 Heizzonen (inbegriffen 1 Abschluss-Element mod. TPA-7)
• **FR** Plaque gaz lisse CHROME POLI, sur armoire ouvert, plaque cm.76x51 - 2 zones de cuisson (inclus 1 Elément de jonction top mod. TPA-7)
• **ES** Fry-top gas liso CROMO PULIDO, sobre mueble abierto, plancha cm.76x51 - 2 zonas de cocción (incluida 1 Chapa de cierre para top mod.TPA-7)

cm. 80x 70,5x 90h



14 kW
12.040 kcal/h

4.255,00
114 / 0,71

FTLR-78G
08230852

FRY-TOP GAS 1/2 RIGATO + 1/2 LISCIO, SU MOBILE A GIORNO, PIASTRA CM.76X51 - 2 ZONE DI COTTURA (INCLUSA 1 TESTATA CHIUSURA PIANO MOD.TPA-7)

EN Gas Fry-top 1/2 grooved + 1/2 smooth, on open cabinet, plate cm.76x51 - 2 cooking areas (included 1 Head end filler strip mod.TPA-7)
• **DE** Gas-griddleplatte 1/2 gerillt + 1/2 glatt, mit offenem Unterbau, platte cm.76x51 - 2 Heizzonen (inbegriffen 1 Abschluss-Element mod.TPA-7)
• **FR** Plaque gaz 1/2 nervurée + 1/2 lisse, sur armoire ouvert, plaque cm.76x51 - 2 zones de cuisson (inclus 1 Elément de jonction top mod. TPA-7)
• **ES** Fry-top gas 1/2 estriado + 1/2 liso, sobre mueble abierto, plancha cm.76x51 - 2 zonas de cocción (incluida 1 Chapa de cierre para top mod.TPA-7)

cm. 80x 70,5x 90h



14 kW
12.040 kcal/h

3.786,00
114 / 0,71

FTLR-78GS
08230855

FRY-TOP GAS 1/2 RIGATO + 1/2 LISCIO CROMATO SUPERCHROME (MOCA APPROVED), SU MOBILE A GIORNO, PIASTRA CM.76X51 - 2 ZONE DI COTTURA (INCLUSA 1 TESTATA CHIUSURA PIANO MOD.TPA-7)

EN Gas Fry-top 1/2 grooved + 1/2 smooth chromed griddle SUPERCHROME (Moca Approved), on open cabinet, plate cm.76x51 - 2 cooking areas (included 1 Head end filler strip mod.TPA-7)
• **DE** Gas-griddleplatte 1/2 gerillt + 1/2 glatt hartverchromt SUPERCHROME (Moca Approved), mit offenem Unterbau, platte cm.76x51 - 2 Heizzonen (inbegriffen 1 Abschluss-Element mod.TPA-7)
• **FR** Plaque gaz 1/2 nervurée + 1/2 lisse chromée SUPERCHROME (Moca Approved), sur armoire ouvert, plaque cm.76x51 - 2 zones de cuisson (inclus 1 Elément de jonction top mod.TPA-7)
• **ES** Fry-top gas 1/2 estriado + 1/2 liso cromado SUPERCHROME (Moca Approved), sobre mueble abierto, plancha cm.76x51 - 2 zonas de cocción (incluida 1 Chapa de cierre para top mod.TPA-7)

cm. 80x 70,5x 90h



14 kW
12.040 kcal/h

4.439,00
114 / 0,71

FTR-78G
08230853

FRY-TOP GAS RIGATO, SU MOBILE A GIORNO, PIASTRA CM.76X51 - 2 ZONE DI COTTURA (INCLUSA 1 TESTATA CHIUSURA PIANO MOD.TPA-7)

EN Gas Fry-top grooved griddle, on open cabinet, plate cm.76x51 - 2 cooking areas (included 1 Head end filler strip mod.TPA-7)
• **DE** Gas-griddleplatte gerillt, mit offenem Unterbau, platte cm.76x51 - 2 Heizzonen (inbegriffen 1 Abschluss-Element mod.TPA-7)
• **FR** Plaque gaz nervurée, sur armoire ouvert, plaque cm.76x51 - 2 zones de cuisson (inclus 1 Elément de jonction top mod.TPA-7)
• **ES** Fry-top gas estriado, sobre mueble abierto, plancha cm.76x51 - 2 zonas de cocción (incluida 1 Chapa de cierre para top mod.TPA-7)

cm. 80x 70,5x 90h



14 kW
12.040 kcal/h

3.961,00
114 / 0,71

FTR-78GS
08230856

FRY-TOP GAS RIGATO CROMATO SUPERCHROME (MOCA APPROVED), SU MOBILE A GIORNO, PIASTRA CM.76X51 - 2 ZONE DI COTTURA (INCLUSA 1 TESTATA CHIUSURA PIANO MOD.TPA-7)

EN Gas Fry-top grooved chromed griddle SUPERCHROME (Moca Approved), on open cabinet, plate cm.76x51 - 2 cooking areas (included 1 Head end filler strip mod.TPA-7)
• **DE** Gas-griddleplatte gerillt hartverchromt SUPERCHROME (Moca Approved), mit offenem Unterbau, platte cm.76x51 - 2 Heizzonen (inbegriffen 1 Abschluss-Element mod.TPA-7)
• **FR** Plaque gaz nervurée chromée SUPERCHROME (Moca Approved), sur armoire ouvert, plaque cm.76x51 - 2 zones de cuisson (inclus 1 Elément de jonction top mod.TPA-7)
• **ES** Fry-top gas estriado cromado SUPERCHROME (Moca Approved), sobre mueble abierto, plancha cm.76x51 - 2 zonas de cocción (incluida 1 Chapa de cierre para top mod.TPA-7)

cm. 80x 70,5x 90h



14 kW
12.040 kcal/h

4.633,00
114 / 0,71

MOD. _____
COD. _____

DESCRIZIONE/DESCRIPTION/BEZEICHNUNG/DESCRIPTION/DESCRIPCIÓN
DIMENSIONI/DIMENSIONS/ABMESSUNGEN/DIMENSIONS/DIMENSIONES

POTENZA/POWER/LEISTUNG/PUISSANCE/POTENCIA
VOLTAGGIO/VOLTAGE/SPANNUNG/VOLTAGE/VOLTAJE

⚡ 21 kW
18.060 kcal/h

PREZZO/PRICE
PREIS/PRIX/PRECIO
KG / M³



FTL-712G
08231251

FRY-TOP GAS LISCIO, SU MOBILE A GIORNO, PIASTRA CM.116X51 - 2 ZONE DI COTTURA (INCLUSA 1 TESTATA CHIUSURA PIANO MOD.TPA-7)

EN Gas Fry-top smooth griddle, on open cabinet, plate cm.116x51 - 2 cooking areas (included 1 Head end filler strip mod.TPA-7) • **DE** Gas-griddleplatte glatt, mit offenem Unterbau, platte cm.116x51 - 2 Heizzonen (inbegriffen 1 Abschluss-Element mod.TPA-7) • **FR** Plaque gaz lisse, sur armoire ouvert, plaque cm.116x51 - 2 zones de cuisson (inclus 1 Élément de jonction top mod.TPA-7) • **ES** Fry-top gas liso, sobre mueble abierto, plancha cm.116x51 - 2 zonas de cocción (incluida 1 Chapa de cierre para top mod.TPA-7)

cm. 120x 70,5x 90h



⚡ 21 kW
18.060 kcal/h

4.543,00
154 / 1,05

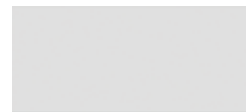

FTL-712GS
08231254

FRY-TOP GAS LISCIO CROMATO SUPERCHROME (MOCA APPROVED), SU MOBILE A GIORNO, PIASTRA CM.116X51 - 2 ZONE DI COTTURA (INCLUSA 1 TESTATA CHIUSURA PIANO MOD.TPA-7)

EN Gas Fry-top smooth chromed griddle SUPERCHROME (Moca Approved), on open cabinet, plate cm.116x51 - 2 cooking areas (included 1 Head end filler strip mod.TPA-7) • **DE** Gas-griddleplatte glatt hartverchromt SUPERCHROME (Moca Approved), mit offenem Unterbau, platte cm.116x51 - 2 Heizzonen (inbegriffen 1 Abschluss-Element mod.TPA-7) • **FR** Plaque gaz lisse chromée SUPERCHROME (Moca Approved), sur armoire ouvert, plaque cm.116x51 - 2 zones de cuisson (inclus 1 Élément de jonction top mod.TPA-7) • **ES** Fry-top gas liso cromado SUPERCHROME (Moca Approved), sobre mueble abierto, plancha cm.116x51 - 2 zonas de cocción (incluida 1 Chapa de cierre para top mod.TPA-7)

cm. 120x 70,5x 90h

⚡ 21 kW
18.060 kcal/h

5.364,00
154 / 1,05



FTLR-712G
08231252

FRY-TOP GAS 1/2 RIGATO + 1/2 LISCIO, SU MOBILE A GIORNO, PIASTRA CM.116X51 - 2 ZONE DI COTTURA (INCLUSA 1 TESTATA CHIUSURA PIANO MOD.TPA-7)

EN Gas Fry-top 1/2 grooved + 1/2 smooth, on open cabinet, plate cm.116x51 - 2 cooking areas (included 1 Head end filler strip mod.TPA-7) • **DE** Gas-griddleplatte 1/2 gerillt + 1/2 glatt, mit offenem Unterbau, platte cm.116x51 - 2 Heizzonen (inbegriffen 1 Abschluss-Element mod.TPA-7) • **FR** Plaque gaz 1/2 nervurée + 1/2 lisse, sur armoire ouvert, plaque cm.116x51 - 2 zones de cuisson (inclus 1 Élément de jonction top mod.TPA-7) • **ES** Fry-top gas 1/2 estriado + 1/2 liso, sobre mueble abierto, plancha cm.116x51 - 2 zonas de cocción (incluida 1 Chapa de cierre para top mod.TPA-7)

cm. 120x 70,5x 90h



⚡ 21 kW
18.060 kcal/h

4.770,00
154 / 1,05



FTLR-712GS
08231255

FRY-TOP GAS 1/2 RIGATO + 1/2 LISCIO CROMATO SUPERCHROME (MOCA APPROVED), SU MOBILE A GIORNO, PIASTRA CM.116X51 - 2 ZONE DI COTTURA (INCLUSA 1 TESTATA CHIUSURA PIANO MOD.TPA-7)

EN Gas Fry-top 1/2 grooved + 1/2 smooth chromed griddle SUPERCHROME (Moca Approved), on open cabinet, plate cm.116x51 - 2 cooking areas (included 1 Head end filler strip mod.TPA-7) • **DE** Gas-griddleplatte 1/2 gerillt + 1/2 glatt hartverchromt SUPERCHROME (Moca Approved), mit offenem Unterbau, platte cm.116x51 - 2 Heizzonen (inbegriffen 1 Abschluss-Element mod.TPA-7) • **FR** Plaque gaz 1/2 nervurée + 1/2 lisse chromée SUPERCHROME (Moca Approved), sur armoire ouvert, plaque cm.116x51 - 2 zones de cuisson (inclus 1 Élément de jonction top mod.TPA-7) • **ES** Fry-top gas 1/2 estriado + 1/2 liso cromado SUPERCHROME (Moca Approved), sobre mueble abierto, plancha cm.116x51 - 2 zonas de cocción (incluida 1 Chapa de cierre para top mod.TPA-7)

cm. 120x 70,5x 90h

⚡ 21 kW
18.060 kcal/h

5.552,00
154 / 1,05



MOD. _____
COD. _____

DESCRIZIONE/DESCRIPTION/BEZEICHNUNG/DESCRIPTION/DESCRIPCIÓN
DIMENSIONI/DIMENSIONS/ABMESSUNGEN/DIMENSIONS/DIMENSIONES

POTENZA/POWER/LEISTUNG/PUISSANCE/POTENCIA
VOLTAGGIO/VOLTAGE/SPANNUNG/VOLTAGE/VOLTAJE

⚡ 21 kW
18.060 kcal/h

PREZZO/PRICE
PREIS/PRIX/PRECIO
KG / M³



FRF-712G
08231253

FRY-TOP GAS RIGATO, SU MOBILE A GIORNO, PIASTRA CM.116X51 - 2 ZONE DI COTTURA (INCLUSA 1 TESTATA CHIUSURA PIANO MOD.TPA-7)

EN Gas Fry-top grooved griddle, on open cabinet, plate cm.116x51 - 2 cooking areas (included 1 Head end filler strip mod.TPA-7) • **DE** Gas-griddleplatte gerillt, mit offenem Unterbau, platte cm.116x51 - 2 Heizzonen (inbegriffen 1 Abschluss-Element mod.TPA-7) • **FR** Plaque gaz nervurée, sur armoire ouvert, plaque cm.116x51 - 2 zones de cuisson (inclus 1 Élément de jonction top mod.TPA-7) • **ES** Fry-top gas estriado, sobre mueble abierto, plancha cm.116x51 - 2 zonas de cocción (incluida 1 Chapa de cierre para top mod.TPA-7)
cm. 120x 70,5x 90h



⚡ 21 kW
18.060 kcal/h

5.001,00
154 / 1,05



FRF-712GS
08231256

FRY-TOP GAS RIGATO CROMATO SUPERCHROME (MOCA APPROVED), SU MOBILE A GIORNO, PIASTRA CM.116X51 - 2 ZONE DI COTTURA (INCLUSA 1 TESTATA CHIUSURA PIANO MOD.TPA-7)

EN Gas Fry-top grooved chromed griddle SUPERCHROME (Moca Approved), on open cabinet, plate cm.116x51 - 2 cooking areas (included 1 Head end filler strip mod.TPA-7) • **DE** Gas-griddleplatte gerillt hartverchromt SUPERCHROME (Moca Approved), mit offenem Unterbau, platte cm.116x51 - 2 Heizzonen (inbegriffen 1 Abschluss-Element mod.TPA-7) • **FR** Plaque gaz nervurée chromée SUPERCHROME (Moca Approved), sur armoire ouvert, plaque cm.116x51 - 2 zones de cuisson (inclus 1 Élément de jonction top mod.TPA-7) • **ES** Fry-top gas estriado cromado SUPERCHROME (Moca Approved), sobre mueble abierto, plancha cm.116x51 - 2 zonas de cocción (incluida 1 Chapa de cierre para top mod.TPA-7)
cm. 120x 70,5x 90h

⚡ 21 kW
18.060 kcal/h

5.795,00
154 / 1,05



FTL-712G3
0823125B

FRY-TOP GAS LISCIO, SU MOBILE A GIORNO, PIASTRA CM.116X51 - 3 ZONE DI COTTURA (INCLUSA 1 TESTATA CHIUSURA PIANO MOD.TPA-7)

EN Gas Fry-top smooth griddle, on open cabinet, plate cm.116x51 - 3 cooking areas (included 1 Head end filler strip mod.TPA-7) • **DE** Gas-griddleplatte glatt, mit offenem Unterbau, platte cm.116x51 - 3 Heizzonen (inbegriffen 1 Abschluss-Element mod.TPA-7) • **FR** Plaque gaz lisse, sur armoire ouvert, plaque cm.116x51 - 3 zones de cuisson (inclus 1 Élément de jonction top mod.TPA-7) • **ES** Fry-top gas liso, sobre mueble abierto, plancha cm.116x51 - 3 zonas de cocción (incluida 1 Chapa de cierre para top mod.TPA-7)
cm. 120x 70,5x 90h



⚡ 21 kW
18.060 kcal/h

4.892,00
154 / 1,05



FTL-712GS3
0823125E

FRY-TOP GAS LISCIO CROMATO SUPERCHROME (MOCA APPROVED), SU MOBILE A GIORNO, PIASTRA CM.116X51 - 3 ZONE DI COTTURA (INCLUSA 1 TESTATA CHIUSURA PIANO MOD.TPA-7)

EN Gas Fry-top smooth chromed griddle SUPERCHROME (Moca Approved), on open cabinet, plate cm.116x51 - 3 cooking areas (included 1 Head end filler strip mod.TPA-7) • **DE** Gas-griddleplatte glatt hartverchromt SUPERCHROME (Moca Approved), mit offenem Unterbau, platte cm.116x51 - 3 Heizzonen (inbegriffen 1 Abschluss-Element mod.TPA-7) • **FR** Plaque gaz lisse chromée SUPERCHROME (Moca Approved), sur armoire ouvert, plaque cm.116x51 - 3 zones de cuisson (inclus 1 Élément de jonction top mod.TPA-7) • **ES** Fry-top gas liso cromado SUPERCHROME (Moca Approved), sobre mueble abierto, plancha cm.116x51 - 3 zonas de cocción (incluida 1 Chapa de cierre para top mod.TPA-7)
cm. 120x 70,5x 90h

⚡ 21 kW
18.060 kcal/h

5.695,00
154 / 1,05



FTL-712GSS3
0823125Y

FRY-TOP GAS LISCIO CROMO LUCIDO, SU MOBILE A GIORNO, PIASTRA CM.116X51 - 3 ZONE DI COTTURA (INCLUSA 1 TESTATA CHIUSURA PIANO MOD.TPA-7)

EN Gas Fry-top smooth POLISHED CHROME, on open cabinet, plate cm.116x51 - 3 cooking areas (included 1 Head end filler strip mod.TPA-7) • **DE** Gas-griddleplatte glatt POLIERTEM CHROM, mit offenem Unterbau, platte cm.116x51 - 3 Heizzonen (inbegriffen 1 Abschluss-Element mod.TPA-7) • **FR** Plaque gaz lisse CHROME POLI, sur armoire ouvert, plaque cm.116x51 - 3 zones de cuisson (inclus 1 Élément de jonction top mod.TPA-7) • **ES** Fry-top gas liso CROMO PULIDO, sobre mueble abierto, plancha cm.116x51 - 3 zonas de cocción (incluida 1 Chapa de cierre para top mod.TPA-7)
cm. 120x 70,5x 90h

⚡ 21 kW
18.060 kcal/h

5.695,00
154 / 1,05



MOD. _____
COD. _____

DESCRIZIONE/DESCRIPTION/BEZEICHNUNG/DESCRIPTION/DESCRIPCIÓN
DIMENSIONI/DIMENSIONS/ABMESSUNGEN/DIMENSIONS/DIMENSIONES

POTENZA/POWER/LEISTUNG/PUISSANCE/POTENCIA
VOLTAGGIO/VOLTAGE/SPANNUNG/VOLTAGE/VOLTAJE

⚡ kW _____
kcal/h _____
V~ _____
Hz _____

PREZZO/PRICE
PREIS/PRIX/PRECIO
KG / M³



FTLR-712G3 FRY-TOP GAS 1/3 RIGATO + 2/3 LISCIO, SU MOBILE A GIORNO, PIASTRA CM.116X51 - 3 ZONE DI COTTURA (INCLUSA 1 TESTATA CHIUSURA PIANO MOD.TPA-7)

0823125C

EN Gas Fry-top 1/3 grooved + 2/3 smooth, on open cabinet, plate cm.116x51 - 3 cooking areas (included 1 Head end filler strip mod.TPA-7)
• DE Gas-griddleplatte 1/3 gerillt + 2/3 glatt, mit offenem Unterbau, platte cm.116x51 - 3 Heizzonen (inbegriffen 1 Abschluss-Element mod. TPA-7)
• FR Plaque gaz 1/3 nervurée + 2/3 lisse, sur armoire ouvert, plaque cm.116x51 - 3 zones de cuisson (inclus 1 Élément de jonction top mod.TPA-7)
• ES Fry-top gas 1/3 estriado + 2/3 liso, sobre mueble abierto, plancha cm.116x51 - 3 zonas de cocción (incluida 1 Chapa de cierre para top mod.TPA-7)
cm. 120x 70,5x 90h



⚡ 21 kW _____ **5.010,00**
18.060 kcal/h _____ 154 / 1,05



FTLR-712GS3 FRY-TOP GAS 1/3 RIGATO + 2/3 LISCIO CROMATO SUPERCHROME (MOCA APPROVED), SU MOBILE A GIORNO, PIASTRA CM.116X51 - 3 ZONE DI COTTURA (INCLUSA 1 TESTATA CHIUSURA PIANO MOD.TPA-7)

0823125F

EN Gas Fry-top 1/3 grooved + 2/3 smooth chromed SUPERCHROME (Moca Approved), on open cabinet, plate cm.116x51 - 3 cooking areas (included 1 Head end filler strip mod.TPA-7)
• DE Gas-griddleplatte 1/3 gerillt + 2/3 glatt hartverchromt SUPERCHROME (Moca Approved), mit offenem Unterbau, platte cm.116x51 - 3 Heizzonen (inbegriffen 1 Abschluss-Element mod.TPA-7)
• FR Plaque gaz 1/3 nervurée + 2/3 lisse chromée AW770:AW833pproved), sur armoire ouvert, plaque cm.116x51 - 3 zones de cuisson (inclus 1 Élément de jonction top mod.TPA-7)
• ES Fry-top gas 1/3 estriado + 2/3 liso cromado SUPERCHROME (Moca Approved), sobre mueble abierto, plancha cm.116x51 - 3 zonas de cocción (incluida 1 Chapa de cierre para top mod.TPA-7)
cm. 120x 70,5x 90h



⚡ 21 kW _____ **5.887,00**
18.060 kcal/h _____ 154 / 1,05



RSFT-73EM PIASTRA PER SANDWICH SOPRA FRYTOP ELETTRICI - PIASTRA CM. 29X40 (ATTENZIONE: PROFONDITA' MACCHINA +CM.10)

18630317

EN Sandwiches plate above electric gridde - plate cm. 29x40 (ATTENTION: DEPTH MACHINE +cm.10)
• DE Sandwiches Platte über Elektrische Griddle - platte cm. 29x40 (VORSICHT: TIEFE MACHINE +cm.10)
• FR Plaque pour sandwiches au-dessus électrique fry-top - plaque cm. 29x40 (ATTENTION: PROFONDEUR MACHINE +cm.10)
• ES Plancia para sándwiches sobre fry-top eléctrico - plancia cm. 29x40 (ATENCIÓN: PROFUNDIDAD MÁQUINA +cm.10)
cm. 32x 62x 41h



⚡ 2,9 KW _____ **1.382,00**
230V~ _____ 20 / 0,21
50/60 Hz _____

CWK-74ET GRIGLIA CONTACT SU MOBILE A GIORNO - COTTURA DIRETTA SU RESISTENZA IN ACCIAIO INOX CM. 27X43 RIBALTABILE (INCLUSA 1 TESTATA CHIUSURA PIANO MOD. TPA-7)

08080431

EN CONTACT Grill threephase on open cabinet - rotatable stainless steel grill cm. 27x43 (included 1 Head end filler strip mod.TPA-7)
• DE Wurstbrater dreiphasig KONTAKT mit offenem Unterbau - Drehbaren Heizelement aus Edelstahl cm. 27x43 (inbegriffen 1 Abschluss-Element mod.TPA-7)
• FR Grillade triphase CONTACT sur armoire ouvert- Grille inox rotatif cm 27x43 (inclus 1 Élément de jonction top mod.TPA-7)
• ES Parrilla trifásico CONTACT sobre mueble abierto - Parrilla giratoria de acero inox cm 27x43 (incluida 1 Chapa de cierre para top mod.TPA-7)
cm. 40x 70,5x 90h



⚡ 4,08 KW _____ **3.074,00**
400V~3N _____ 60 / 0,37
50/60 Hz _____

CWK-78ET GRIGLIA CONTACT SU MOBILE A GIORNO - COTTURA DIRETTA SU RESISTENZA IN ACCIAIO INOX CM. 55X43 RIBALTABILE - 2 ZONE COTTURA (INCLUSA 1 TESTATA CHIUSURA PIANO MOD.TPA-7)

08080831

EN CONTACT Grill threephase on open cabinet - rotatable stainless steel grill cm. 55x43 - 2 cooking areas (included 1 Head end filler strip mod. TPA-7)
• DE Wurstbrater dreiphasig KONTAKT mit offenem Unterbau - Drehbaren Heizelement aus Edelstahl cm. 55x43 - 2 Heizzonen (inbegriffen 1 Abschluss-Element mod.TPA-7)
• FR Grillade triphase CONTACT sur armoire ouvert- Grille inox rotatif cm 55x43 - 2 zones de cuisson (inclus 1 Élément de jonction top mod.TPA-7)
• ES Parrilla trifásico CONTACT sobre mueble abierto - Parrilla giratoria de acero inox cm 55x43 - 2 zonas de cocción (incluida 1 Chapa de cierre para top mod.TPA-7)
cm. 80x 70,5x 90h

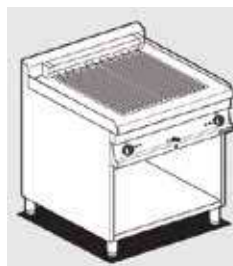

⚡ 8,16 KW _____ **3.970,00**
400V~3N _____ 90 / 0,71
50/60 Hz _____

MOD. _____
COD. _____

DESCRIZIONE/DESCRIPTION/BEZEICHNUNG/DESCRIPTION/DESCRIPCIÓN
DIMENSIONI/DIMENSIONS/ABMESSUNGEN/DIMENSIONS/DIMENSIONES

POTENZA/POWER/LEISTUNG/PUISSANCE/POTENCIA
VOLTAGGIO/VOLTAGE/SPANNUNG/VOLTAGE/VOLTAJE

⚡ kW
kcal/h
V~
Hz

PREZZO/PRICE
PREIS/PRIX/PRECIO
KG / M³



CW-74ET
08080430

GRIGLIA TRIFASE SU MOBILE A GIORNO GRIGLIA IN ACCIAIO INOX CM. 38X52 REGOLABILE (INCLUSA 1 TESTATA CHIUSURA PIANO MOD.TPA-7)

EN Grill threephase on open cabinet Stainless steel grill cm. 38x52 (included 1 Head end filler strip mod.TPA-7) • **DE** Wurstbrater dreiphasig mit offenem Unterbau Einstellbarer Rost aus Nirosta cm. 38x52 (inbegriffen 1 Abschluss-Element mod.TPA-7) • **FR** Grillade triphase sur armoire ouvert Grille inox cm 38x52 (inclus 1 Elément de jonction top mod.TPA-7) • **ES** Parrilla trifásico sobre mueble abierto Parrilla de acero inox regulable cm 38x52 (incluida 1 Chapa de cierre para top mod. TPA-7)

cm. 40x 70,5x 90h



⚡ 6 kW
400V~3N
230V~3
50/60 Hz

2.365,00
62 / 0,40

CW-78ET
08080830

GRIGLIA TRIFASE SU MOBILE A GIORNO N. 2 GRIGLIE IN ACCIAIO INOX CM. 38X52 REGOLABILI 2 ZONE DI COTTURA (INCLUSA 1 TESTATA CHIUSURA PIANO MOD.TPA-7)

EN Grill threephase on open cabinet N. 2 Stainless steel grill cm. 38x52. 2 cooking areas (included 1 Head end filler strip mod.TPA-7) • **DE** Wurstbrater dreiphasig mit offenem Unterbau - Nr. 2 einstellbare Roste aus Nirosta cm. 38x52 - 2 Heizzonen (inbegriffen 1 Abschluss-Element mod. TPA-7) • **FR** Grillade triphase sur armoire ouvert N. 2 grilles réglables en acier inox cm. 38x52 2 zones de cuisson (inclus 1 Elément de jonction top mod.TPA-7) • **ES** Parrilla trifásico sobre mueble abierto - N. 2 Parrillas de acero inox regulable cm 38x52 - 2 zonas de cocción (incluida 1 Chapa de cierre para top mod.TPA-7)

cm. 80x 70,5x 90h



⚡ 12 kW
400V~3N
230V~3
50/60 Hz

3.329,00
94 / 0,78

CW-74G
08250450

GRIGLIA GAS-PIETRALAVICA SU MOBILE A GIORNO GRIGLIA IN ACCIAIO INOX CM. 38X52 REGOLABILE (INCLUSA 1 TESTATA CHIUSURA PIANO MOD.TPA-7)

EN Charcoal grill gas on open cabinet Stainless steel grill cm. 38x52 (included 1 Head end filler strip mod.TPA-7) • **DE** Gas-Lavasteingrill mit offenem Unterbau Einstellbarer Rost aus Nirosta cm. 38x52 (inbegriffen 1 Abschluss-Element mod.TPA-7) • **FR** Grille à gaz en pierre de lave sur armoire ouvert Grille inox cm 38x52 (inclus 1 Elément de jonction top mod.TPA-7) • **ES** Parrilla a gas piedra lávica sobre mueble abierto Parrilla de acero inox regulable cm 38x52 (incluida 1 Chapa de cierre para top mod.TPA-7)

cm. 40x 70,5x 90h



⚡ 9 kW
7.740 kcal/h

2.394,00
61 / 0,40

CW-78G
08250850

GRIGLIA GAS-PIETRALAVICA SU MOBILE A GIORNO N. 2 GRIGLIE IN ACCIAIO INOX CM. 38X52 REGOLABILI 2 ZONE DI COTTURA. (INCLUSA 1 TESTATA CHIUSURA PIANO MOD. TPA-7)

EN Charcoal grill gas on open cabinet N. 2 Stainless steel grill cm. 38x52. 2 cooking areas (included 1 Head end filler strip mod.TPA-7) • **DE** Gas-Lavasteingrill mit offenem Unterbau - N. 2 einstellbare Roste aus Nirosta cm. 38x52 - 2 Heizzonen (inbegriffen 1 Abschluss-Element mod.TPA-7) • **FR** Grille a gaz en pierre de lave sur armoire ouvert. N. 2 grilles réglables en acier inox cm. 38x52. 2 zones de cuisson (inclus 1 Elément de jonction top mod.TPA-7) • **ES** Parrilla a gas piedra lávica sobre mueble abierto N. 2 Parrillas de acero inox regulable cm 38x52 2 zonas de cocción (incluida 1 Chapa de cierre para top mod.TPA-7)

cm. 80x 70,5x 90h



⚡ 18 kW
15.480 kcal/h

3.599,00
104 / 0,78

F2/8-74ET
08090432

FRIGGITRICE TRIFASE LT. 8+8 2 VASCHE CM. 14,8X35X32,7H - 2 CESTI CM. 12X30X15H - FILTRO E COPERCHIO VASCA. 2 BACINELLE RACCOGLIOLO CON FILTRO. PRODUZIONE PATATE: 12 KG/H (INCLUSA 1 TESTATA CHIUSURA PIANO MOD.TPA-7)

EN Fryer threephase 8+8 lts - 2 Bowls cm. 14,8x35x32,7h - 2 baskets cm. 12x30x15h. Sieve and lid for pan. 2 drip tray with sieves. Production: 12 kg/h (included 1 Head end filler strip mod.TPA-7) • **DE** Friteuse dreiphasig lt. 8+8 - 2 Becken cm. 14,8x35x32,7h - 2 Korb cm. 12x30x15h. Einlegesieb und Deckel für Becken. 2 Fettaufangschalen mit Sieb. Pommes frites: 12 kg/h (inbegriffen 1 Abschluss-Element mod.TPA-7) • **FR** Friteuse triphase lt. 8+8 - 2 Cuve cm. 14,8x35x32,7h - 2 Panier cm. 12x30x15h. Filtre, couvercle pour cuve. 2 bacs de récupération de l'huile avec filtre. Production de pommes frites: 12 kg/h (inclus 1 Elément de jonction top mod.TPA-7) • **ES** Freidoras trifásico 8+8 lt. - 2Cuba cm. 14,8x35x32,7h - 2 cesta cm. 12x30x15h. Filtro y tapa para cuba. 2 bandejas recoge aceite con filtro. Prod. patatas: 12 Kg/h (incluida 1 Chapa de cierre para top mod.TPA-7)

cm. 40x 70,5x 90h



⚡ 12 kW
400V~3N
230V~3
50/60 Hz

3.471,00
59 / 0,37

FRIGGITRICI ELETTRICHE

MOD. _____
COD. _____

DESCRIZIONE/DESCRIPTION/BEZEICHNUNG/DESCRIPTION/DESCRIPCIÓN
DIMENSIONI/DIMENSIONS/ABMESSUNGEN/DIMENSIONS/DIMENSIONES

POTENZA/POWER/LEISTUNG/PUISSANCE/POTENCIA
VOLTAGGIO/VOLTAGE/SPANNUNG/VOLTAGE/VOLTAJE

⚡ kW kcal/h
⚡ kW V~ Hz

PREZZO/PRICE
PREIS/PRIX/PRECIO
KG / M³



F13-74ET
08090430

FRIGGITRICE TRIFASE LT. 13 VASCA CM. 24X35X38H - 1 CESTO CM. 21X30X12H - FILTRO E COPERCHIO VASCA. BACINELLA RACCOGLIOLIO CON FILTRO. PRODUZIONE PATATE: 10 KG/H (INCLUSA 1 TESTATA CHIUSURA PIANO MOD.TPA-7)

EN Fryer threephase 13 lts - Bowl cm. 24x35x38h - 1 basket cm. 21x30x12h. Sieve and lid for pan. Drip tray with sieve. Production: 10 kg/h (included 1 Head end filler strip mod.TPA-7) • **DE** Friteuse dreiphasig lt. 13 - Becken cm. 24x35x38h - 1 Korb cm. 21x30x12h. Einlegesieb und Deckel für Becken. Fettauffangschale mit Sieb. Pommes frites: 10 kg/h (inbegriffen 1 Abschluss-Element mod.TPA-7) • **FR** Friteuse triphase lt. 13 - Cuve cm. 24x35x38h - 1 Panier cm. 21x30x12h. Filtre, couvercle pour cuve. Bac de récupération de l'huile avec filtre. Production de pommes frites: 10 kg/h (inclus 1 Élément de jonction top mod.TPA-7) • **ES** Freidoras trifásico 13 lt. - Cuba cm. 24x35x38h - 1 cesta cm. 21x30x12h. Filtro y tapa para cuba. Bandeja recoge aceite con filtro. Prod. patatas: 10 Kg/h (incluida 1 Chapa de cierre para top mod. TPA-7)

cm. 40x 70,5x 90h



⚡ 10,95 kW **2.502,00**
400V~3N 54 / 0,37
50/60 Hz

F18-74ET
08090431

FRIGGITRICE TRIFASE LT. 18 VASCA CM. 31X34X33H - 1 CESTO CM. 28X29X15H - FILTRO E COPERCHIO VASCA. BACINELLA RACCOGLIOLIO CON FILTRO. PRODUZIONE PATATE: 15 KG/H (INCLUSA 1 TESTATA CHIUSURA PIANO MOD.TPA-7)

EN Fryer threephase 18 lts - Bowl cm. 31x34x33h - 1 basket cm. 28x29x15h. Sieve and lid for pan. Drip tray with sieve. Production: 15 kg/h (included 1 Head end filler strip mod.TPA-7) • **DE** Friteuse dreiphasig lt. 18 - Becken cm. 31x34x33h - 1 Korb cm. 28x29x15h. Einlegesieb und Deckel für Becken. Fettauffangschale mit Sieb. Pommes frites: 15 kg/h (inbegriffen 1 Abschluss-Element mod.TPA-7) • **FR** Friteuse triphase lt. 18 - Cuve cm. 31x34x33h - 1 Panier cm. 28x29x15h. Filtre, couvercle pour cuve. Bac de récupération de l'huile avec filtre. Production de pommes frites: 15 kg/h (inclus 1 Élément de jonction top mod.TPA-7) • **ES** Freidoras trifásico 18 lt. - Cuba cm. 31x34x33h - 1 cesta cm. 28x29x15h. Filtro y tapa para cuba. Bandeja recoge aceite con filtro. Prod. patatas: 15 Kg/h (incluida 1 Chapa de cierre para top mod. TPA-7)

cm. 40x 70,5x 90h

⚡ 15,9 kW **2.709,00**
400V~3N 57 / 0,37
50/60 Hz

F2/13-78ET
08090830

FRIGGITRICE TRIFASE LT. 13+13 2 VASCHE CM. 24X35X38H - 2 CESTI CM. 21X30X12H 2 FILTRI E COPERCHI VASCHE. 2 BACINELLE RACCOGLIOLIO CON FILTRO. PRODUZIONE PATATE: 20 KG/H (INCLUSA 1 TESTATA CHIUSURA PIANO MOD.TPA-7)

EN Fryer threephase 13+13 lts - 2 pans cm. 24x35x38h 2 baskets cm. 21x30x12h. 2 sieve and lids for pan. 2 drip trays with sieves. Production: 20 kg/h (included 1 Head end filler strip mod.TPA-7) • **DE** Friteuse dreiphasig lt. 13+13 - 2 Becken cm. 24x35x38h 2 Körbe cm. 21x30x12h. Einlegesieb und Deckel für Becken. 2 Fettauffangschalen mit Sieb. Pommes frites: 20 kg/h (inbegriffen 1 Abschluss-Element mod.TPA-7) • **FR** Friteuse triphase lt. 13+13 - 2 cuves cm. 24x35x38h 2 paniers cm. 21x30x12h. 2 filtres, couvercles pour cuve. 2 bacs de récupération de l'huile avec filtre. Production de pommes frites: 20 kg/h (inclus 1 Élément de jonction top mod.TPA-7) • **ES** Freidoras trifásico 13+13 lt. - 2 cubas cm. 24x35x38h 2 cestas cm. 21x30x12h. 2 filtros y tapas para cubas. 2 bandejas recoge aceite con filtro. Prod. patatas: 20 Kg/h (incluida 1 Chapa de cierre para top mod.TPA-7)

cm. 80x 70,5x 90h



⚡ 21,9 kW **3.746,00**
400V~3N 95 / 0,71
50/60 Hz

FRIGGITRICI ELETTRICHE

MOD. _____
COD. _____

DESCRIZIONE/DESCRIPTION/BEZEICHNUNG/DESCRIPTION/DESCRIPCIÓN
DIMENSIONI/DIMENSIONS/ABMESSUNGEN/DIMENSIONS/DIMENSIONES

POTENZA/POWER/LEISTUNG/PUISSANCE/POTENCIA
VOLTAGGIO/VOLTAGE/SPANNUNG/VOLTAGE/VOLTAJE

⚡ kW kcal/h
⚡ kW V~ Hz

PREZZO/PRICE
PREIS/PRIX/PRECIO
KG / M³



F2/18-78ET FRIGGITRICE TRIFASE LT. 18+18 2 VASCHE CM. 31X34X33H
08090831 - 2 CESTI CM. 28X29X15H 2 FILTRI E COPERCHI VASCHE.
2 BACINELLE RACCOGLIOLIO CON FILTRO. PRODUZIONE
PATATE: 30 KG/H (INCLUSA 1 TESTATA CHIUSURA PIANO
MOD.TPA-7)

EN Fryer threephase 18+18 lts - 2 pans cm. 31x34x33h 2 baskets
cm. 28x29x15h. 2 sieve and lids for pan. 2 drip trays with sieves.
Production: 30 kg/h (included 1 Head end filler strip mod.TPA-7) • **DE**
Friteuse dreiphasig lt. 18+18 - 2 Becken cm. 31x34x33h 2 Körbe cm.
28x29x15h. Einlegesieb und Deckel für Becken. 2 Fettauffangschalen mit
Sieb. Pommes frites: 30 kg/h (inbegriffen 1 Abschluss-Element mod.TPA-7) • **FR**
Friteuse triphase lt. 18+18 - 2 cuves cm. 31x34x33h 2 paniers cm.
28x29x15h. 2 filtres, couvercles pour cuve. 2 bacs de récupération de
l'huile avec filtre. Production de pommes frites: 30 kg/h (inclus 1 Elément
de jonction top mod.TPA-7) • **ES** Freidoras trifásico 18+18 lt. - 2 cubas
cm. 31x34x33h 2 cestas cm. 28x29x15h. 2 filtros y tapas para cuba.
2 bandejas recoge aceite con filtro. Prod. patatas: 30 Kg/h (incluida 1
Chapa de cierre para top mod.TPA-7)
cm. 80x 70,5x 90h



⚡ 31,8 kW
400V~3N
50/60 Hz
4.166,00
97 / 0,71

F45-78ET FRIGGITRICE TRIFASE LT. 45 VASCA CM. 70X38X38H - 1
08090835 CESTO CM. 65X33X17H - FILTRO E COPERCHIO VASCA.
BACINELLA RACCOGLIOLIO CON FILTRO. PRODUZIONE
PATATE: 40 KG/H (INCLUSA 1 TESTATA CHIUSURA PIANO
MOD.TPA-7)

EN Fryer threephase 45 lts - Bowl cm. 70x38x38h - 1 basket cm.
65x33x17h. Sieve and lid for pan. Drip tray with sieve. Production:
40 kg/h (included 1 Head end filler strip mod.TPA-7) • **DE** Friteuse
dreiphasig lt. 45 - Becken cm. 70x38x38h - 1 Korb cm. 65x33x17h.
Einlegesieb und Deckel für Becken. Fettauffangschale mit Sieb. Pommes
frites: 40 kg/h (inbegriffen 1 Abschluss-Element mod.TPA-7) • **FR**
Friteuse triphase lt. 45 - Cuve cm. 70x38x38h - 1 Panier cm. 65x33x17h.
Filtre, couvercle pour cuve. Bac de récupération de l'huile avec filtre.
Production de pommes frites: 40 kg/h (inclus 1 Elément de jonction top
mod.TPA-7) • **ES** Freidoras trifásico 45 lt. - Cuba cm. 70x38x38h - 1
cesta cm. 65x33x17h. Filtro y tapa para cuba. Bandeja recoge aceite con
filtro. Prod. patatas: 40 Kg/h (incluida 1 Chapa de cierre para top mod.
TPA-7)
cm. 80x 70,5x 90h



⚡ 40 kW
400V~3N
50/60 Hz
4.731,00
96 / 0,71

F2/8-74G FRIGGITRICE GAS LT. 8+8 - 2 VASCHE CM. 15X35X36H 2
08260452 CESTI CM. 12X30X15H. FILTRO E COPERCHIO VASCA. 2
BACINELLE RACCOGLIOLIO CON FILTRO. PROD. PATATE: 12
KG/H (INCLUSA 1 TESTATA CHIUSURA PIANO MOD.TPA-7)

EN Gas Fryer 8+8 lts - 2 pans cm. 15x35x36h 2 baskets cm.
12x30x15h. Sieve and lid for pan. 2 drip trays with sieves. Production:
12 kg/h (included 1 Head end filler strip mod.TPA-7) • **DE** Gas-Friteuse
lt. 8+8 - 2 Becken cm. 15x35x36h 2 Körbe cm. 12x30x15h. Einlegesieb
und Deckel für Becken. 2 Fettauffangschalen mit Sieb. Pommes frites: 12
kg/h (inbegriffen 1 Abschluss-Element mod.TPA-7) • **FR** Friteuse à gaz lt.
8+8 - 2 cuves cm. 15x35x36h 2 paniers cm. 12x30x15h. Filtre, couvercle
pour cuve. 2 bacs de récupération de l'huile avec filtre. Production de
pommes frites: 12 kg/h (inclus 1 Elément de jonction top mod.TPA-7)
• **ES** Freidoras a gas 8+8 lt. - 2 cubas cm. 15x35x36h 2 cestas cm.
12x30x15h. Filtro y tapa para cuba. 2 bandejas recoge aceite con filtro.
Prod. patatas: 12 Kg/h (incluida 1 Chapa de cierre para top mod.TPA-7)
cm. 40x 70,5x 90h



⚡ 10 kW
8.600 kcal/h
4.014,00
59 / 0,37

MOD. _____
COD. _____

DESCRIZIONE/DESCRIPTION/BEZEICHNUNG/DESCRIPTION/DESCRIPCIÓN
DIMENSIONI/DIMENSIONS/ABMESSUNGEN/DIMENSIONS/DIMENSIONES

POTENZA/POWER/LEISTUNG/PUISSANCE/POTENCIA
VOLTAGGIO/VOLTAGE/SPANNUNG/VOLTAGE/VOLTAJE

⚡ kW _____
kcal/h _____
V~ _____
Hz _____

PREZZO/PRICE
PREIS/PRIX/PRECIO
KG / M³



F13-74G
08260450

FRIGGITRICE GAS LT. 13 VASCA CM. 24X35X38H - 1 CESTO CM. 21X30X12H. FILTRO E COPERCHIO VASCA. BACINELLA RACCOGLIOLIO CON FILTRO. PROD. PATATE: 10 KG/H (INCLUDE ENTRAMBE LE TESTATE CHIUSURA PIANO)

EN Gas Fryer 13 lts - Bowl cm. 24x35x38h - 1 basket cm. 21x30x12h. Sieve and lid for pan. Drip tray with sieve. Production: 10 kg/h (included both Heads end filler strip) • DE Gas-Friteuse lt. 13 - Becken cm. 24x35x38h - 1 Korb cm. 21x30x12h. Einlegesieb und Deckel für Becken. Fettauffangschale mit Sieb. Pommes frites: 10 kg/h (inbegriffen alle 2 Abschluss-Element) • FR Friteuse a gaz lt. 13 - Cuve cm. 24x35x38h - 1 Panier cm. 21x30x12h. Filtre, couvercle pour cuve. Bac de récupération de l'huile avec filtre. Production de pommes frites: 10 kg/h (inclus tous 2 Elément de jonction top) • ES Freidoras a gas 13 lt. - Cuba cm. 24x35x38h - 1 cesta cm. 21x30x12h. Filtro y tapa para cuba. Bandeja recoge aceite con filtro. Prod. patatas: 10 Kg/h (incluidas todas las 2 Chapa de cierre para top)
cm. 40x 70,5x 90h



⚡ 9,3 kW _____
8.000 kcal/h _____ **2.546,00**
61 / 0,40

F18-74G
08260451

FRIGGITRICE GAS LT. 18 VASCA CM. 33X38X38H. - 1 CESTO CM. 30X33X12H. FILTRO E COPERCHIO VASCA. BACINELLA RACCOGLIOLIO CON FILTRO. PROD. PATATE: 15 KG/H (INCLUDE ENTRAMBE LE TESTATE CHIUSURA PIANO)

EN Gas Fryer 18 lts - Bowl cm. 33x38x38h - 1 basket cm. 30x33x12h. Sieve and lid for pan. Drip tray with sieve. Production: 15 kg/h (included both Heads end filler strip) • DE Gas-Friteuse lt. 18 - Becken cm. 33x38x38h - 1 Korb cm. 30x33x12h. Einlegesieb und Deckel für Becken. Fettauffangschale mit Sieb. Pommes frites: 15 kg/h (inbegriffen alle 2 Abschluss-Element) • FR Friteuse a gaz lt. 18 - Cuve cm. 33x38x38h - 1 Panier cm. 30x33x12h. Filtre, couvercle pour cuve. - Bac de récupération de l'huile avec filtre. Production de pommes frites: 15 kg/h (inclus tous 2 Elément de jonction top) • ES Freidoras a gas 18 lt. - Cuba cm. 33x38x38h - 1 cesta cm. 30x33x12h. Filtro y tapa para cuba. Bandeja recoge aceite con filtro. Prod. patatas: 15 Kg/h (incluidas todas las 2 Chapa de cierre para top)
cm. 40x 70,5x 90h

⚡ 13,5 kW _____
11.610 kcal/h _____ **2.836,00**
66 / 0,40

F2/13-78G
08260850

FRIGGITRICE GAS LT. 13+13 - 2 VASCHE CM. 24X35X38H 2 CESTI CM. 21X30X12H. 2 FILTRI E COPERCHI VASCHE. 2 BACINELLE RACCOGLIOLIO CON FILTRO. PROD. PATATE: 20 KG/H (INCLUDE ENTRAMBE LE TESTATE CHIUSURA PIANO)

EN Gas Fryer 13+13 lts - 2 pans cm. 24x35x38h 2 baskets cm. 21x30x12h. 2 sieve and lids for pan. 2 drip trays with sieves. Production: 20 kg/h (included both Heads end filler strip) • DE Gas-Friteuse lt. 13+13 - 2 Becken cm. 24x35x38h 2 Körbe cm. 21x30x12h. Einlegesieb und Deckel für Becken. 2 Fettauffangschalen mit Sieb. Pommes frites: 20 kg/h (inbegriffen alle 2 Abschluss-Element) • FR Friteuse à gaz lt. 13+13 - 2 cuves cm. 24x35x38h 2 paniers cm. 21x30x12h. 2 filtres, couvercles pour cuve. 2 bacs de récupération de l'huile avec filtre. Production de pommes frites: 20 kg/h (inclus tous 2 Elément de jonction top) • ES Freidoras a gas 13+13 lt. - 2 cubas cm. 24x35x38h 2 cestas cm. 21x30x12h. 2 filtros y tapas para cubas. 2 bandejas recoge aceite con filtro. Prod. patatas: 20 Kg/h (incluidas todas las 2 Chapa de cierre para top)
cm. 80x 70,5x 90h



⚡ 18,6 kW _____
16.000 kcal/h _____ **4.516,00**
102 / 0,78

F2/18-78G
08260851

FRIGGITRICE GAS LT. 18+18 - 2 VASCHE CM. 33X38X38H 2 CESTI CM. 30X33X12H. 2 FILTRI E COPERCHI VASCHE. 2 BACINELLE RACCOGLIOLIO CON FILTRO. PROD. PATATE: 30 KG/H (INCLUDE ENTRAMBE LE TESTATE CHIUSURA PIANO)

EN Gas Fryer 18+18 lts - 2 pans cm. 33x38x38h 2 baskets cm. 30x33x12h. 2 sieve and lids for pan. 2 drip trays with sieves. Production: 30 kg/h (included both Heads end filler strip) • DE Gas-Friteuse lt. 18+18 - 2 Becken cm. 33x38x38h 2 Körbe cm. 30x33x12h. Einlegesieb und Deckel für Becken. 2 Fettauffangschalen mit Sieb. Pommes frites: 30 kg/h (inbegriffen alle 2 Abschluss-Element) • FR Friteuse à gaz lt. 18+18 - 2 cuves cm. 33x38x38h 2 paniers cm. 30x33x12h. 2 filtres, couvercles pour cuve. 2 bacs de récupération de l'huile avec filtre. Production de pommes frites: 30 kg/h (inclus tous 2 Elément de jonction top) • ES Freidoras a gas 18+18 lt. - 2 cubas cm. 33x38x38h 2 cestas cm. 30x33x12h. 2 filtros y tapas para cuba. 2 bandejas recoge aceite con filtro. Prod. patatas: 30 Kg/h (incluidas todas las 2 Chapa de cierre para top)
cm. 80x 70,5x 90h

⚡ 27 kW _____
23.220 kcal/h _____ **4.970,00**
111 / 0,78

FRIGGITRICI A GAS

MOD. _____
COD. _____

DESCRIZIONE/DESCRIPTION/BEZEICHNUNG/DESCRIPTION/DESCRIPCIÓN
DIMENSIONI/DIMENSIONS/ABMESSUNGEN/DIMENSIONS/DIMENSIONES

POTENZA/POWER/LEISTUNG/PUISSANCE/POTENCIA
VOLTAGGIO/VOLTAGE/SPANNUNG/VOLTAGE/VOLTAJE

⚡ kW kcal/h
⚡ kW V~ Hz

PREZZO/PRICE
PREIS/PRIX/PRECIO
KG / M³



F45-78G
08260855

FRIGGITRICE GAS LT. 45 VASCA CM. 70X38X38H. - 1 CESTO CM. 65X33X17H. FILTRO E COPERCHIO VASCA. BACINELLA RACCOGLIOLIO CON FILTRO. PROD. PATATE: 40 KG/H (INCLUSE ENTRAMBE LE TESTATE CHIUSURA PIANO)

EN Gas Fryer 45 lts - Bowl cm. 70x38x38h - 1 basket cm. 65x33x17h. Sieve and lid for pan. Drip tray with sieve. Production: 40 kg/h (included both Heads end filler strip) • **DE** Gas-Friteuse lt. 45 - Becken cm. 70x38x38h - 1 Korb cm. 65x33x17h. Einlegesieb und Deckel für Becken. Fettaufangschale mit Sieb. Pommes frites: 40 kg/h (inbegriffen alle 2 Abschluss-Element) • **FR** Friteuse a gaz lt. 45 - Cuve cm. 70x38x38h - 1 Panier cm. 65x33x17h. Filtre, couvercle pour cuve. Bac de récupération de l'huile avec filtre. Production de pommes frites: 40 kg/h (inclus tous 2 Elément de jonction top) • **ES** Freidoras a gas 45 lt. - Cuba cm. 70x38x38h - 1 cesta cm. 65x33x17h. Filtro y tapa para cuba. Bandeja recoge aceite con filtro. Prod. patatas: 40 Kg/h (incluidas todas las 2 Chapa de cierre para top)
cm. 80x 70,5x 90h



⚡ 44 kW 5.621,00
37.840 kcal/h 110 / 1,07

⚡ 0,005 kW
230V~
50 Hz

F18-74ETD
0815A430

FRIGGITRICE ELETTRICA ELETTRONICA CON TOUCHSCREEN 7". CONSERVAZIONE A 110 °C O PRELAVORO A 160 °C CON O SENZA MELTING. POSSIBILITÀ DI INSERIRE IN MEMORIA FINO A 100 PROGRAMMI. SENSORE PRESENZA E LIVELLO MASSIMO OLIO. VASCA 18 LITRI CM.31X34X33H - 2 CESTI CM.13,5X29X21H - FILTRO E COPERCHIO VASCA. BACINELLA RACCOLTA OLIO CON SUPPORTO SU RUOTE. PRODUZIONE PATATE: 27 KG/H (INCLUSA 1 TESTATA CHIUSURA PIANO MOD.TPA-7)

EN Electric electronic Fryer with a 7" TouchScreen. Conservation at 110 °C and preworking at 160 °C with or without Melting. Possibility to store in the memory up to 100 programs. Oil presence sensor and maximum level sensor. Bowl 18 lts cm.31x34x33h - 2 baskets cm.13,5x29x21h. Sieve and lid for pan. Oil collection basin with support on wheels. Production: 27 kg/h (included 1 Head end filler strip mod. TPA-7) • **DE** ELEKTRONISCHE ELEKTRISCHE FRITEUSE mit TouchScreen 7". Aufbewahrung bei 110 °C oder Vorbereitung bei 160 °C mit oder ohne Melting. Es können bis zu 100 Programme gespeichert werden. Anwesenheits- sowie maximaler Ölstandsensor. Becken 18 lt. cm.31x34x33h - 2 Körbe cm.13,5x29x21h. Einlegesieb und Deckel für Becken. Ölauffangbecken mit Halterung auf Rädern. Pommes frites: 27 kg/h (inbegriffen 1 Abschluss-Element mod.TPA-7) • **FR** FRITEUSE ÉLECTRIQUE ÉLECTRONIQUE à Écran tactile 7". Conservation à 110 °C ou Pré-traitement à 160 °C avec ou sans Melting. Possibilité d'enregistrer jusqu'à 100 programmes en mémoire. Capteur de présence et de niveau maximal huile. Cuve 18 lt. cm.31x34x33h - 2 Paniers cm.13,5x29x21h. Filtre, couvercle pour cuve. Bassine de collecte de l'huile avec support sur roues. Production de pommes frites: 27 kg/h (inclus 1 Elément de jonction top mod.TPA-7) • **ES** FREIDORA ELÉCTRICA ELECTRÓNICA con pantalla táctil de 7". Conservación a 110 °C o trabajo previo a 160 °C con o sin fusión. Se pueden almacenar hasta 100 programas en la memoria. Sensor de presencia y nivel máximo de aceite. Cuba de 18 litros cm. 31x34x33h - 2 cestas cm.13,5x29x21h. Filtro y tapa para cuba. Cubeta de recogida de aceite con soporte sobre ruedas. Prod. patatas: 27 Kg/h (incluida 1 Chapa de cierre para top mod.TPA-7)
cm. 40x 70,5x 90h



⚡ 15,95 kW 6.148,00
400V~3N 63 / 0,40
50/60 Hz

MOD. _____
COD. _____

DESCRIZIONE/DESCRIPTION/BEZEICHNUNG/DESCRIPTION/DESCRIPCIÓN
DIMENSIONI/DIMENSIONS/ABMESSUNGEN/DIMENSIONS/DIMENSIONES

POTENZA/POWER/LEISTUNG/PUISSANCE/POTENCIA
VOLTAGGIO/VOLTAGE/SPANNUNG/VOLTAGE/VOLTAJE

⚡ kW kcal/h
⚡ kW V~ Hz

PREZZO/PRICE
PREIS/PRIX/PRECIO
KG / M³



F18-74ETDP 0815A431 **FRIGGITRICE ELETTRICA ELETTRONICA CON TOUCHSCREEN 7". CONSERVAZIONE A 110 °C O PRELAVORO A 160 °C CON O SENZA MELTING. POSSIBILITÀ DI INSERIRE IN MEMORIA FINO A 100 PROGRAMMI. SENSORE PRESENZA E LIVELLO MASSIMO OLIO. POMPA FILTRAGGIO OLIO A CALDO MAX 180°C, PULIZIA VASCA, SVUOTAMENTO VASCA. VASCA 18 LITRI CM.31X34X33H - 2 CESTI CM.13,5X29X21H - FILTRO E COPERCHIO VASCA. BACINELLA RACCOLTA OLIO CON SUPPORTO SU RUOTE E FILTRO 5 MICRON (PZ.100 INCLUSI). PRODUZIONE PATATE: 27 KG/H (INCLUSA 1 TESTATA CHIUSURA PIANO MOD.TPA-7)**

EN Electric electronic Fryer with a 7" TouchScreen. Conservation at 110 °C and preworking at 160 °C with or without Melting. Possibility to store in the memory up to 100 programs. Oil presence sensor and maximum level sensor. Pump for filter the hot oil max 180°C, Tank cleaning, Tank emptying. Bowl 18 lts cm.31x34x33h - 2 baskets cm.13,5x29x21h. Sieve and lid for pan. Oil collection basin with support on wheels with sieve 5 microns (pcs.100 included). Production: 27 kg/h (included 1 Head end filler strip mod.TPA-7) • **DE** ELEKTRONISCHE ELEKTRISCHE FRITEUSE mit TouchScreen 7". Aufbewahrung bei 110 °C oder Vorbearbeitung bei 160 °C mit oder ohne Melting. Es können bis zu 100 Programme gespeichert werden. Anwesenheits- sowie maximaler Ölstandsensoren. Heißölfilterpumpe max 180°C, Tankreinigung, Tankentleerung. Becken 18 lt. cm.31x34x33h - 2 Körbe cm.13,5x29x21h. Einlegesieb und Deckel für Becken. Ölauffangbecken mit Halterung auf Rädern und 5-Mikron-Filter (Stk.100 inbegriffen). Pommes frites: 27 kg/h (inbegriffen 1 Abschluss-Element mod.TPA-7) • **FR** FRITEUSE ÉLECTRIQUE ÉLECTRONIQUE à Écran tactile 7". Conservation à 110 °C ou Pré-traitement à 160 °C avec ou sans Melting. Possibilité d'enregistrer jusqu'à 100 programmes en mémoire. Capteur de présence et de niveau maximal huile. Pompe filtration huile à chaud max 180°C, nettoyage cuve, vidange cuve. Cuve 18 lt. cm.31x34x33h - 2 Paniers cm.13,5x29x21h. Filtre, couvercle pour cuve. Bassine de collecte de l'huile avec support sur roues et filtre 5 microns (pcs.100 inclus). Production de pommes frites: 27 kg/h (inclus 1 Élément de jonction top mod.TPA-7) • **ES** FREIDORA ELÉCTRICA ELECTRÓNICA con pantalla táctil de 7". Conservación a 110 °C o trabajo previo a 160 °C con o sin fusión. Se pueden almacenar hasta 100 programas en la memoria. Sensor de presencia y nivel máximo de aceite. Bomba de filtrado de aceite caliente, máximo 180 °C, limpieza del tanque, vaciado del tanque. Cuba de 18 litros cm. 31x34x33h - 2 cestas cm.13,5x29x21h. Filtro y tapa para cuba. Cubeta de recogida de aceite con soporte sobre ruedas y filtro de 5 micrones (pz.100 incluida). Prod. patatas: 27 Kg/h (incluida 1 Chapa de cierre para top mod.TPA-7)

cm. 40x 70,5x 90h



⚡ 16,2 kW
400V~3N
50/60 Hz

9.470,00
73 / 0,40

FRIGGITRICI ELETTRICHE DIGITALI

MOD. _____
COD. _____

DESCRIZIONE/DESCRIPTION/BEZEICHNUNG/DESCRIPTION/DESCRIPCIÓN
DIMENSIONI/DIMENSIONS/ABMESSUNGEN/DIMENSIONS/DIMENSIONES

POTENZA/POWER/LEISTUNG/PUISSANCE/POTENCIA
VOLTAGGIO/VOLTAGE/SPANNUNG/VOLTAGE/VOLTAJE

⚡ kW
kcal/h

⚡ kw
V~
Hz

PREZZO/PRICE
PREIS/PRIX/PRECIO
KG / M³



F18-74ETDPS FRIGGITRICE ELETTRICA ELETTRONICA CON TOUCHSCREEN 0815A432 7". CONSERVAZIONE A 110 °C O PRELAVORO A 160 °C CON O SENZA MELTING. POSSIBILITÀ DI INSERIRE IN

MEMORIA FINO A 100 PROGRAMMI. SENSORE PRESENZA E LIVELLO MASSIMO OLIO. POMPA FILTRAGGIO OLIO A CALDO MAX 180°C, PULIZIA VASCA, SVUOTAMENTO VASCA. 2 SOLLEVATORI CESTI INTEGRATI. VASCA 18 LITRI CM.31X34X33H - 2 CESTI CM.13,5X29X21H - FILTRO E COPERCHIO VASCA. BACINELLA RACCOLTA OLIO CON SUPPORTO SU RUOTE E FILTRO 5 MICRON (PZ.100 INCLUSI). PRODUZIONE PATATE: 27 KG/H (INCLUSA 1 TESTATA CHIUSURA PIANO MOD.TPA-7)

EN Electric electronic Fryer with a 7" TouchScreen. Conservation at 110 °C and preworking at 160 °C with or without Melting. Possibility to store in the memory up to 100 programs. Oil presence sensor and maximum level sensor. Pump for filter the hot oil max 180°C, Tank cleaning, Tank emptying. 2 Lifter for baskets integrated. Bowl 18 lts cm.31x34x33h - 2 baskets cm.13,5x29x21h. Sieve and lid for pan. Oil collection basin with support on wheels with sieve 5 microns (pcs.100 included). Production: 27 kg/h (included 1 Head end filler strip mod.TPA-7) • **DE** ELEKTRONISCHE ELEKTRISCHE FRITEUSE mit TouchScreen 7". Aufbewahrung bei 110 °C oder Vorbearbeitung bei 160 °C mit oder ohne Melting. Es können bis zu 100 Programme gespeichert werden. Anwesenheits- sowie maximaler Ölstandsensoren. Heißölfilterpumpe max 180°C, Tankreinigung, Tankentleerung. Integrierte 2 Korbheber. Becken 18 lt. cm.31x34x33h - 2 Körbe cm.13,5x29x21h. Einlegesieb und Deckel für Becken. Ölauffangbecken mit Halterung auf Rädern und 5-Mikron-Filter (Stk.100 inbegriffen). Pommes frites: 27 kg/h (inbegriffen 1 Abschluss-Element mod.TPA-7) • **FR** FRITEUSE ÉLECTRIQUE ÉLECTRONIQUE à Écran tactile 7". Conservation à 110 °C ou Pré-traitement à 160 °C avec ou sans Melting. Possibilité d'enregistrer jusqu'à 100 programmes en mémoire. Capteur de présence et de niveau maximal huile. Pompe filtration huile à chaud max 180°C, nettoyage cuve, vidange cuve. 2 Élévateurs paniers intégrés. Cuve 18 lt. cm.31x34x33h - 2 Paniers cm.13,5x29x21h. Filtre, couvercle pour cuve. Bassine de collecte de l'huile avec support sur roues et filtre 5 microns (pcs.100 inclus). Production de pommes frites: 27 kg/h (inclus 1 Élément de jonction top mod.TPA-7) • **ES** FREIDORA ELÉCTRICA ELECTRÓNICA con pantalla táctil de 7". Conservación a 110 °C o trabajo previo a 160 °C con o sin fusión. Se pueden almacenar hasta 100 programas en la memoria. Sensor de presencia y nivel máximo de aceite. Bomba de filtrado de aceite caliente, máximo 180 °C, limpieza del tanque, vaciado del tanque. 2 Elevadores de cesta integrados. Cuba de 18 litros cm. 31x34x33h - 2 cestas cm.13,5x29x21h. Filtro y tapa para cuba. Cubeta de recogida de aceite con soporte sobre ruedas y filtro de 5 micrones (pz.100 incluida). Prod. patatas: 27 Kg/h (incluida 1 Chapa de cierre para top mod.TPA-7)

cm. 40x 70,5x 90h



⚡ 16,55 kW **11.796,00**
400V~3N 83 / 0,40
50/60 Hz

MOD. _____
COD. _____

DESCRIZIONE/DESCRIPTION/BEZEICHNUNG/DESCRIPTION/DESCRIPCIÓN
DIMENSIONI/DIMENSIONS/ABMESSUNGEN/DIMENSIONS/DIMENSIONES

POTENZA/POWER/LEISTUNG/PUISSANCE/POTENCIA
VOLTAGGIO/VOLTAGE/SPANNUNG/VOLTAGE/VOLTAJE

⚡ kW kcal/h
⚡ kW
V~
Hz

PREZZO/PRICE
PREIS/PRIX/PRECIO
KG / M³



F2/18-78ETD FRIGGITRICE ELETTRICA ELETTRONICA CON TOUCHSCREEN 7". CONSERVAZIONE A 110 °C O PRELAVORO A 160 °C CON O SENZA MELTING. POSSIBILITÀ DI INSERIRE IN MEMORIA FINO A 100 PROGRAMMI. SENSORE PRESENZA E LIVELLO MASSIMO OLIO. 2 VASCHE 18 LITRI CM.31X34X33H - 4 CESTI CM.13,5X29X21H - FILTRI E COPERCHI VASCHE. 2 BACINELLE RACCOLTA OLIO CON SUPPORTO SU RUOTE. PRODUZIONE PATATE: 54 KG/H (INCLUSA 1 TESTATA CHIUSURA PIANO MOD.TPA-7)

0815A830



⚡ 31,9 kW
400V~3N
50/60 Hz

11.139,00
109 / 0,78

EN Electric electronic Fryer with a 7" TouchScreen. Conservation at 110 °C and preworking at 160 °C with or without Melting. Possibility to store in the memory up to 100 programs. Oil presence sensor and maximum level sensor. 2 bowls 18 lts cm.31x34x33h - 4 baskets cm.13,5x29x21h. 2 Sieve and lid for pan. 2 Oil collection basin with support on wheels. Production: 54 kg/h (included 1 Head end filler strip mod.TPA-7) • **DE** ELEKTRONISCHE ELEKTRISCHE FRITEUSE mit TouchScreen 7". Aufbewahrung bei 110 °C oder Vorbearbeitung bei 160 °C mit oder ohne Melting. Es können bis zu 100 Programme gespeichert werden. Anwesenheits- sowie maximaler Ölstandsensor. 2 Becken 18 lt. cm.31x34x33h - 4 Körbe cm.13,5x29x21h. 2 Einlegesieb und Deckel für Becken. Ölauffangbecken mit Halterung auf Rädern. Pommes frites: 54 kg/h (inbegriffen 1 Abschluss-Element mod.TPA-7) • **FR** FRITEUSE ÉLECTRIQUE ÉLECTRONIQUE à Écran tactile 7". Conservation à 110 °C ou Pré-traitement à 160 °C avec ou sans Melting. Possibilité d'enregistrer jusqu'à 100 programmes en mémoire. Capteur de présence et de niveau maximal huile. 2 Cuves 18 lt. cm.31x34x33h - 4 Paniers cm.13,5x29x21h. 2 Filtre, couvercle pour cuve. 2 Bassine de collecte de l'huile avec support sur roues. Production de pommes frites: 54 kg/h (inclus 1 Élément de jonction top mod.TPA-7) • **ES** FREIDORA ELÉCTRICA ELECTRÓNICA con pantalla táctil de 7". Conservación a 110 °C o trabajo previo a 160 °C con o sin fusión. Se pueden almacenar hasta 100 programas en la memoria. Sensor de presencia y nivel máximo de aceite. 2 Cubas de 18 litros cm. 31x34x33h - 4 cestas cm.13,5x29x21h. 2 Filtros y tapas para cuba. 2 Cubetas de recogida de aceite con soporte sobre ruedas. Prod. patatas: 54 Kg/h (incluida 1 Chapa de cierre para top mod.TPA-7)

cm. 80x 70,5x 90h

FRIGGITRICI ELETTRICHE DIGITALI

MOD. _____
COD. _____

DESCRIZIONE/DESCRIPTION/BEZEICHNUNG/DESCRIPTION/DESCRIPCIÓN
DIMENSIONI/DIMENSIONS/ABMESSUNGEN/DIMENSIONS/DIMENSIONES

POTENZA/POWER/LEISTUNG/PUISSANCE/POTENCIA
VOLTAGGIO/VOLTAGE/SPANNUNG/VOLTAGE/VOLTAJE

⚡ kW kcal/h
⚡ kW V~ Hz

PREZZO/PRICE
PREIS/PRIX/PRECIO
KG / M³



F2/18-78ETDP FRIGGITRICE ELETTRICA ELETTRONICA CON TOUCHSCREEN 7". CONSERVAZIONE A 110 °C O PRELAVORO A 160 °C CON O SENZA MELTING. POSSIBILITÀ DI INSERIRE IN MEMORIA FINO A 100 PROGRAMMI. SENSORE PRESENZA E LIVELLO MASSIMO OLIO. 2 POMPE FILTRAGGIO OLIO A CALDO MAX 180°C, PULIZIA VASCA, SVUOTAMENTO VASCA. 2 VASCHE 18 LITRI CM.31X34X33H - 4 CESTI CM.13,5X29X21H - FILTRI E COPERCHI VASCHE. 2 BACINELLE RACCOLTA OLIO CON SUPPORTO SU RUOTE E FILTRO 5 MICRON (PZ.100 INCLUSI). PRODUZIONE PATATE: 54 KG/H (INCLUSA 1 TESTATA CHIUSURA PIANO MOD.TPA-7)

EN Electric electronic Fryer with a 7" TouchScreen. Conservation at 110 °C and preworking at 160 °C with or without Melting. Possibility to store in the memory up to 100 programs. Oil presence sensor and maximum level sensor. 2 Pump for filter the hot oil max 180°C, Tank cleaning, Tank emptying. 2 bowls 18 lts cm.31x34x33h - 4 baskets cm.13,5x29x21h. 2 Sieve and lid for pan. 2 Oil collection basin with support on wheels with sieve 5 microns (pcs.100 included). Production: 54 kg/h (included 1 Head end filler strip mod.TPA-7) • **DE** ELEKTRONISCHE ELEKTRISCHE FRITEUSE mit TouchScreen 7". Aufbewahrung bei 110 °C oder Vorbearbeitung bei 160 °C mit oder ohne Melting. Es können bis zu 100 Programme gespeichert werden. Anwesenheits- sowie maximaler Ölstandsensoren. 2 Heißölfilterpumpe max 180°C, Tankreinigung, Tankentleerung. 2 Becken 18 lt. cm.31x34x33h - 4 Körbe cm.13,5x29x21h. 2 Einlegesieb und Deckel für Becken. 2 Ölauffangbecken mit Halterung auf Rädern und 5-Mikron-Filter (Stk.100 inbegriffen). Pommes frites: 54 kg/h (inbegriffen 1 Abschluss-Element mod.TPA-7) • **FR** FRITEUSE ÉLECTRIQUE ÉLECTRONIQUE à Écran tactile 7". Conservation à 110 °C ou Pré-traitement à 160 °C avec ou sans Melting. Possibilité d'enregistrer jusqu'à 100 programmes en mémoire. Capteur de présence et de niveau maximal huile. 2 Pompe filtration huile à chaud max 180°C, nettoyage cuve, vidange cuve. 2 Cuves 18 lt. cm.31x34x33h - 4 Paniers cm.13,5x29x21h. 2 Filtre, couvercle pour cuve. 2 Bassine de collecte de l'huile avec support sur roues et filtre 5 microns (pcs.100 inclus). Production de pommes frites: 54 kg/h (inclus 1 Élément de jonction top mod.TPA-7) • **ES** FREIDORA ELÉCTRICA ELECTRÓNICA con pantalla táctil de 7". Conservación a 110 °C o trabajo previo a 160 °C con o sin fusión. Se pueden almacenar hasta 100 programas en la memoria. Sensor de presencia y nivel máximo de aceite. 2 Bomba de filtrado de aceite caliente, máximo 180 °C, limpieza del tanque, vaciado del tanque. 2 Cubas de 18 litros cm. 31x34x33h - 4 cestas cm.13,5x29x21h. 2 Filtros y tapas para cuba. 2 Cubetas de recogida de aceite con soporte sobre ruedas y filtro de 5 micrones (pz.100 incluida). Prod. patatas: 54 Kg/h (incluida 1 Chapa de cierre para top mod.TPA-7)

cm. 80x 70,5x 90h



⚡ 32,4 kW **17.784,00**
400V~3N 129 / 0,78
50/60 Hz

FRIGGITRICI ELETTRICHE DIGITALI

MOD. _____
COD. _____

DESCRIZIONE/DESCRIPTION/BEZEICHNUNG/DESCRIPTION/DESCRIPCIÓN
DIMENSIONI/DIMENSIONS/ABMESSUNGEN/DIMENSIONS/DIMENSIONES

POTENZA/POWER/LEISTUNG/PUISSANCE/POTENCIA
VOLTAGGIO/VOLTAGE/SPANNUNG/VOLTAGE/VOLTAJE

⚡ kW kcal/h
⚡ kW V~ Hz

PREZZO/PRICE PREIS/PRIX/PRECIO
KG / M³



F2/18-78ETDPS FRIGGITRICE ELETTRICA ELETTRONICA CON TOUCHSCREEN 7". CONSERVAZIONE A 110 °C O PRELAVORO A 160 °C CON O SENZA MELTING. POSSIBILITÀ DI INSERIRE IN MEMORIA FINO A 100 PROGRAMMI. SENSORE PRESENZA E LIVELLO MASSIMO OLIO. 2 POMPE FILTRAGGIO OLIO A CALDO MAX 180°C, PULIZIA VASCA, SVUOTAMENTO VASCA. 4 SOLLEVATORI CESTI INTEGRATI. 2 VASCHE 18 LITRI CM.31X34X33H - 4 CESTI CM.13,5X29X21H - FILTRI E COPERCHI VASCHE. 2 BACINELLE RACCOLTA OLIO CON SUPPORTO SU RUOTE E FILTRO 5 MICRON (PZ.100 INCLUSI). PRODUZIONE PATATE: 54 KG/H (INCLUSA 1 TESTATA CHIUSURA PIANO MOD.TPA-7)

0815A832

EN Electric electronic Fryer with a 7" TouchScreen. Conservation at 110 °C and preworking at 160 °C with or without Melting. Possibility to store in the memory up to 100 programs. Oil presence sensor and maximum level sensor. 2 Pump for filter the hot oil max 180°C, Tank cleaning, Tank emptying. 4 Lifter for baskets integrated. 2 bowls 18 lts cm.31x34x33h - 4 baskets cm.13,5x29x21h. 2 Sieve and lid for pan. 2 Oil collection basin with support on wheels with sieve 5 microns (pcs.100 included). Production: 54 kg/h (included 1 Head end filler strip mod. TPA-7) • **DE** ELEKTRONISCHE ELEKTRISCHE FRITEUSE mit TouchScreen 7". Aufbewahrung bei 110 °C oder Vorbearbeitung bei 160 °C mit oder ohne Melting. Es können bis zu 100 Programme gespeichert werden. Anwesenheits- sowie maximaler Ölstandsensoren. 2 Heißölfilterpumpe max 180°C, Tankreinigung, Tankentleerung. Integrierte 4 Korbheber. 2 Becken 18 lt. cm.31x34x33h - 4 Körbe cm.13,5x29x21h. 2 Einlegesieb und Deckel für Becken. 2 Ölauffangbecken mit Halterung auf Rädern und 5-Mikron-Filter (Stk.100 inbegriffen). Pommes frites: 54 kg/h (inbegriffen 1 Abschluss-Element mod.TPA-7) • **FR** FRITEUSE ÉLECTRIQUE ÉLECTRONIQUE à Écran tactile 7". Conservation à 110 °C ou Pré-traitement à 160 °C avec ou sans Melting. Possibilité d'enregistrer jusqu'à 100 programmes en mémoire. Capteur de présence et de niveau maximal huile. 2 Pompe filtration huile à chaud max 180°C, nettoyage cuve, vidange cuve. 4 Élévateurs paniers intégrés. 2 Cuve 18 lt. cm.31x34x33h - 4 Paniers cm.13,5x29x21h. 2 Filtre, couvercle pour cuve. 2 Bassine de collecte de l'huile avec support sur roues et filtre 5 microns (pcs.100 inclus). Production de pommes frites: 54 kg/h (inclus 1 Élément de jonction top mod.TPA-7) • **ES** FREIDORA ELÉCTRICA ELECTRÓNICA con pantalla táctil de 7". Conservación a 110 °C o trabajo previo a 160 °C con o sin fusión. Se pueden almacenar hasta 100 programas en la memoria. Sensor de presencia y nivel máximo de aceite. 2 Bomba de filtrado de aceite caliente, máximo 180 °C, limpieza del tanque, vaciado del tanque. 4 Elevadores de cesta integrados. 2 Cubas de 18 litros cm. 31x34x33h - 4 cestas cm.13,5x29x21h. 2 Filtros y tapas para cuba. 2 Cubetas de recogida de aceite con soporte sobre ruedas y filtro de 5 micrones (pz.100 incluida). Prod. patatas: 54 Kg/h (incluida 1 Chapa de cierre para top mod.TPA-7)

cm. 80x 70,5x 90h



⚡ 33,1 kW **22.436,00**
400V~3N 149 / 0,78
50/60 Hz

BR50-78ETF/I BRASIERA A RIBALTAMENTO MANUALE, VASCA 50 LITRI CM.72X46,5X22H, FONDO INOX CON COPERCHIO

08070835

EN Braising pan with manual tilting, bowl 50 lt. cm.72x46,5x22h, Stainless steel bottom with lid • **DE** Kippbratpfanne mit manual Kippung, 50 Lt. cm.72x46,5x22h, boden aus crnst. mit deckel • **FR** Sauteuse avec basculement manuel, cuve 50 lt. cm.72x46,5x22h, fond inox avec couvercle • **ES** Sartén con levantamiento manual, cuba 50 lt. cm.72x46,5x22h, fondo de acero inox con tapa

cm. 80x 70,5x 90h



⚡ 10,5 kW **5.796,00**
400V~3N 133 / 0,71
50/60 Hz

BRM50-78ETF/I BRASIERA A RIBALTAMENTO AUTOMATICO, VASCA 50 LITRI CM.72X46,5X22H, FONDO INOX CON COPERCHIO

08070836

EN Braising pan with automatic tilting, bowl 50 lt. cm.72x46,5x22h, Stainless steel bottom with lid • **DE** Kippbratpfanne mit automatisch Kippung, 50 Lt. cm.72x46,5x22h, boden aus crnst. mit deckel • **FR** Sauteuse avec basculement automatique, cuve 50 lt. cm.72x46,5x22h, fond inox avec couvercle • **ES** Sartén con levantamiento automatico, cuba 50 lt. cm.72x46,5x22h, fondo de acero inox con tapa

cm. 80x 70,5x 90h



⚡ 10,6 kW **7.279,00**
400V~3N 135 / 0,71
50 Hz

BRASIERE RIBALTABILI A GAS

MOD. _____
COD. _____

DESCRIZIONE/DESCRIPTION/BEZEICHNUNG/DESCRIPTION/DESCRIPCIÓN
DIMENSIONI/DIMENSIONS/ABMESSUNGEN/DIMENSIONS/DIMENSIONES

POTENZA/POWER/LEISTUNG/PUISSANCE/POTENCIA
VOLTAGGIO/VOLTAGE/SPANNUNG/VOLTAGE/VOLTAJE

⚡ $\frac{\text{kW}}{\text{kcal/h}}$ $\frac{\text{kW}}{\text{V~}}$
Hz

PREZZO/PRICE
PREIS/PRIX/PRECIO
KG / M³



BR50-78GF/I BRASIERA A RIBALTAMENTO MANUALE, VASCA 50 LITRI
08240855 **CM.72X46,5X22H, FONDO INOX CON COPERCHIO**

EN Braising pan with manual tilting, bowl 50 lt. cm.72x46,5x22h, Stainless steel bottom with lid • **DE** Kippbratpfanne mit manual Kippung, 50 Lt. cm.72x46,5x22h, boden aus crnst. mit deckel • **FR** Sauteuse avec basculement manuel, cuve 50 lt. cm.72x46,5x22h, fond inox avec couvercle • **ES** Sartén con levantamiento manual, cuba 50 lt. cm.72x46,5x22h, fondo de acero inox con tapa
cm. 80x 70,5x 90h



⚡ $\frac{14 \text{ kW}}{12.040 \text{ kcal/h}}$ **6.310,00**
135 / 0,71

BRM50-78GF/I BRASIERA A RIBALTAMENTO AUTOMATICO, VASCA 50 LITRI
08240856 **CM.72X46,5X22H, FONDO INOX CON COPERCHIO**

EN Braising pan with automatic tilting, bowl 50 lt. cm.72x46,5x22h, Stainless steel bottom with lid • **DE** Kippbratpfanne mit automatisch Kippung, 50 Lt. cm.72x46,5x22h, boden aus crnst. mit deckel • **FR** Sauteuse avec basculement automatique, cuve 50 lt. cm.72x46,5x22h, fond inox avec couvercle • **ES** Sartén con levantamiento automatico, cuba 50 lt. cm.72x46,5x22h, fondo de acero inox con tapa
cm. 80x 70,5x 90h



⚡ $\frac{14 \text{ kW}}{12.040 \text{ kcal/h}}$ **7.558,00**
139 / 0,71

⚡ $\frac{0,1 \text{ kW}}{230\text{V~}}$
50 Hz

BRF-74ET BRASIERA FISSA MULTIFUNZIONALE ELETTRICA VASCA CM.
08070433 **30X51X10H (INCLUSA 1 TESTATA CHIUSURA PIANO MOD. TPA-7)**

EN Electric multi-function fixed braising pan - Bowl cm. 30x51x10h (included 1 Head end filler strip mod.TPA-7) • **DE** Elektrische Multifunktionsbratpfanne Fest Becken cm. 30x51x10h (inbegriffen 1 Abschluss-Element mod.TPA-7) • **FR** Sauteuse fixe multifonction électrique - Cuve cm. 30x51x10h (inclus 1 Élément de jonction top mod.TPA-7) • **ES** Sarten fija multifunción eléctrica - Cuba cm. 30x51x10h (incluida 1 Chapa de cierre para top mod.TPA-7)
cm. 40x 70,5x 90h



⚡ $\frac{4 \text{ kW}}{400\text{V~}2\text{N}}$ **3.758,00**
 $\frac{230\text{V~}3}{50/60 \text{ Hz}}$ 79 / 0,37

BRF-78ET BRASIERA FISSA MULTIFUNZIONALE ELETTRICA VASCA CM.
08070833 **70X51X10H (INCLUSA 1 TESTATA CHIUSURA PIANO MOD. TPA-7)**

EN Electric multi-function fixed braising pan - Bowl cm. 70x51x10h (included 1 Head end filler strip mod.TPA-7) • **DE** Elektrische Multifunktionsbratpfanne Fest Becken cm. 70x51x10h (inbegriffen 1 Abschluss-Element mod.TPA-7) • **FR** Sauteuse fixe multifonction électrique - Cuve cm. 70x51x10h (inclus 1 Élément de jonction top mod.TPA-7) • **ES** Sarten fija multifunción eléctrica - Cuba cm. 70x51x10h (incluida 1 Chapa de cierre para top mod.TPA-7)
cm. 80x 70,5x 90h



⚡ $\frac{8 \text{ kW}}{400\text{V~}3\text{N}}$ **5.684,00**
 $\frac{50/60 \text{ Hz}}$ 126 / 0,71

BRF-74G BRASIERA FISSA MULTIFUNZIONALE GAS VASCA
08240453 **30X51X10H (INCLUSA 1 TESTATA CHIUSURA PIANO MOD. TPA-7)**

EN Gas multi-function fixed braising pan Bowl 30x51x10h (included 1 Head end filler strip mod.TPA-7) • **DE** Gas-Multifunktionsbratpfanne Fest Becken 30x51x10h (inbegriffen 1 Abschluss-Element mod.TPA-7) • **FR** Sauteuse fixe multifonction à gaz - Cuve 30x51x10h (inclus 1 Élément de jonction top mod.TPA-7) • **ES** Sarten fija multifunción a gas - Cuba 30x51x10h (incluida 1 Chapa de cierre para top mod.TPA-7)
cm. 40x 70,5x 90h



⚡ $\frac{6,95 \text{ kW}}{5.970 \text{ kcal/h}}$ **3.942,00**
79 / 0,37

BRF-78G BRASIERA FISSA MULTIFUNZIONALE GAS VASCA
08240853 **70X51X10H (INCLUSA 1 TESTATA CHIUSURA PIANO MOD. TPA-7)**

EN Gas multi-function fixed braising pan Bowl 70x51x10h (included 1 Head end filler strip mod.TPA-7) • **DE** Gas-Multifunktionsbratpfanne Fest Becken 70x51x10h (inbegriffen 1 Abschluss-Element mod.TPA-7) • **FR** Sauteuse fixe multifonction à gaz - Cuve 70x51x10h (inclus 1 Élément de jonction top mod.TPA-7) • **ES** Sarten fija multifunción a gas - Cuba 70x51x10h (incluida 1 Chapa de cierre para top mod.TPA-7)
cm. 80x 70,5x 90h



⚡ $\frac{13,9 \text{ kW}}{11.940 \text{ kcal/h}}$ **6.069,00**
129 / 0,71

MOD. _____
COD. _____

DESCRIZIONE/DESCRIPTION/BEZEICHNUNG/DESCRIPTION/DESCRIPCIÓN
DIMENSIONI/DIMENSIONS/ABMESSUNGEN/DIMENSIONS/DIMENSIONES

POTENZA/POWER/LEISTUNG/PUISSANCE/POTENCIA
VOLTAGGIO/VOLTAGE/SPANNUNG/VOLTAGE/VOLTAJE

⚡ kW kcal/h
⚡ kw V~ Hz

PREZZO/PRICE
PREIS/PRIX/PRECIO
KG / M³



PL-72
08010200

PIANO LAVORO SU MOBILE (INCLUSA 1 TESTATA CHIUSURA PIANO MOD.TPA-7)

EN Worktop on cabinet (included 1 Head end filler strip mod.TPA-7)
• **DE** Arbeitsplatte mit Unterbau (inbegriffen 1 Abschluss-Element mod.TPA-7) • **FR** Plan de travail sur armoire (inclus 1 Élément de jonction top mod.TPA-7) • **ES** Sobre de trabajo sobre mueble (incluida 1 Chapa de cierre para top mod.TPA-7)
cm. 20x 70,5x 90h



720,00
30 / 0,37

PLS-73
08010301

PIANO LAVORO SU MOBILE A GIORNO (INCLUSA 1 TESTATA CHIUSURA PIANO MOD.TPA-7)

EN Worktop on open cabinet (included 1 Head end filler strip mod.TPA-7)
• **DE** Arbeitsplatte mit offenem Unterbau (inbegriffen 1 Abschluss-Element mod.TPA-7) • **FR** Plan de travail sur armoire ouvert (inclus 1 Élément de jonction top mod.TPA-7) • **ES** Sobre de trabajo sobre mueble abierto (incluida 1 Chapa de cierre para top mod.TPA-7)
cm. 30x 70,5x 90h



869,00
35 / 0,37

PLS-74
08010401

cm. 40x 70,5x 90h



896,00
40 / 0,37

PLS-76
08010601

cm. 60x 70,5x 90h



1.353,00
47 / 0,54

PLS-78
08010801

cm. 80x 70,5x 90h



1.513,00
55 / 0,71

PL-73
08010300

PIANO LAVORO SU MOBILE A GIORNO CASSETTO - 1 BACINELLA INOX CM 19X50X15H (INCLUSA 1 TESTATA CHIUSURA PIANO MOD.TPA-7)

EN Worktop on open cabinet Drawer - 1 inox container cm 19x50x15h (included 1 Head end filler strip mod.TPA-7) • **DE** Arbeitsplatte mit offenem Unterbau Schublade - 1 Chromnickelstahlbehälter cm 19x50x15h (inbegriffen 1 Abschluss-Element mod.TPA-7) • **FR** Plan de travail sur armoire ouvert Tiroir - Bac en inox cm 19x50x15h (inclus 1 Élément de jonction top mod.TPA-7) • **ES** Sobre de trabajo sobre mueble abierto Cajón - 1 contenedor cm 19x50x15h de acero inox (incluida 1 Chapa de cierre para top mod.TPA-7)
cm. 30x 70,5x 90h



1.180,00
40 / 0,37

MOD. _____
COD. _____

DESCRIZIONE/DESCRIPTION/BEZEICHNUNG/DESCRIPTION/DESCRIPCIÓN
DIMENSIONI/DIMENSIONS/ABMESSUNGEN/DIMENSIONS/DIMENSIONES

POTENZA/POWER/LEISTUNG/PUISSANCE/POTENCIA
VOLTAGGIO/VOLTAGE/SPANNUNG/VOLTAGE/VOLTAJE

⚡ kW kcal/h
⚡ kw V~ Hz

PREZZO/PRICE
PREIS/PRIX/PRECIO
KG / M³



PL-74
08010400

PIANO LAVORO SU MOBILE A GIORNO CASSETTO CON 1 BACINELLA GN 1/1 15H PLASTICA (INCLUSA 1 TESTATA CHIUSURA PIANO MOD.TPA-7)

EN Worktop on open cabinet Drawer with 1 plastic container GN 1/1 15h (included 1 Head end filler strip mod.TPA-7) • **DE** Arbeitsplatte mit offenem Unterbau Schublade mit 1 GN 1/1 15h Kunststoffbehälter (inbegriffen 1 Abschluss-Element mod.TPA-7) • **FR** Plan de travail sur armoire ouvert Tiroir avec bac en plastique GN 1/1 15h. (inclus 1 Élément de jonction top mod.TPA-7) • **ES** Sobre de trabajo sobre mueble abierto Cajón con 1 contenedor GN 1/1 15h plástico (incluida 1 Chapa de cierre para top mod.TPA-7)

cm. 40x 70,5x 90h



1.137,00
45 / 0,37

PL-76
08010600

PIANO LAVORO SU MOBILE A GIORNO CASSETTO - 1 BACINELLA INOX CM 49X50X15H (INCLUSA 1 TESTATA CHIUSURA PIANO MOD.TPA-7)

EN Worktop on open cabinet Drawer - 1 inox container cm 49x50x15h (included 1 Head end filler strip mod.TPA-7) • **DE** Arbeitsplatte mit offenem Unterbau Schublade - 1 Chromnickelstahlbehälter cm 49x50x15h (inbegriffen 1 Abschluss-Element mod.TPA-7) • **FR** Plan de travail sur armoire ouvert Tiroir - Bac en inox cm 49x50x15h (inclus 1 Élément de jonction top mod.TPA-7) • **ES** Sobre de trabajo sobre mueble abierto Cajón - 1 contenedor cm 49x50x15h de acero inox (incluida 1 Chapa de cierre para top mod.TPA-7)

cm. 60x 70,5x 90h



1.621,00
56 / 0,54

PL-78
08010800

PIANO LAVORO SU MOBILE A GIORNO CASSETTO CON 2 BACINELLE GN 1/1 15H PLASTICA (INCLUSA 1 TESTATA CHIUSURA PIANO MOD.TPA-7)

EN Worktop on open cabinet Drawer with 2 plastic containers GN 1/1 15h (included 1 Head end filler strip mod.TPA-7) • **DE** Arbeitsplatte mit offenem Unterbau Schublade mit 2 GN 1/1 15h Kunststoffbehälter (inbegriffen 1 Abschluss-Element mod.TPA-7) • **FR** Plan de travail sur armoire ouvert Tiroir avec 2 bacs en plastique GN 1/1 15h (inclus 1 Élément de jonction top mod.TPA-7) • **ES** Sobre de trabajo sobre mueble abierto Cajón con 2 contenedores GN 1/1 15h plástico (incluida 1 Chapa de cierre para top mod.TPA-7)

cm. 80x 70,5x 90h



1.809,00
67 / 0,71

LA-74
08020400

LAVELLO SU MOBILE A GIORNO RUBINETTO A LEVA - VASCA CM. 30X35X15H (INCLUSA 1 TESTATA CHIUSURA PIANO MOD.TPA-7)

EN Sink unit on open cabinet - Lever type tap. Bowl cm. 30x35x15h (included 1 Head end filler strip mod.TPA-7) • **DE** Spülbecken Einhebel-Mischbatterie mit offenem Unterbau - Becken cm. 30x35x15h (inbegriffen 1 Abschluss-Element mod.TPA-7) • **FR** Bac-évier sur armoire ouvert avec robinetterie - Bac cm. 30x35x15h (inclus 1 Élément de jonction top mod.TPA-7) • **ES** Fregadero sobre mueble abierto - Grifo a palanca - Pileta cm. 30x35x15h (incluida 1 Chapa de cierre para top mod.TPA-7)

cm. 40x 70,5x 90h



1.449,00
45 / 0,37

P-73/93-DX
08430300

PORTA 300 DESTRA

EN Right door 300 • **DE** Rechte tür 300 • **FR** Porte droite 300 • **ES** Puerta derecha 300

cm. 29,5x 2,5x 47,5h



197,00
3 / 0,01

P-74/94-DX
08430400

PORTA 400 DESTRA

EN Right door 400 • **DE** Rechte tür 400 • **FR** Porte droite 400 • **ES** Puerta derecha 400

cm. 39,5x 2,5x 47,5h

204,00
3.5 / 0,02

MOD. _____
COD. _____

DESCRIZIONE/DESCRIPTION/BEZEICHNUNG/DESCRIPTION/DESCRIPCIÓN
DIMENSIONI/DIMENSIONS/ABMESSUNGEN/DIMENSIONS/DIMENSIONES

POTENZA/POWER/LEISTUNG/PUISSANCE/POTENCIA
VOLTAGGIO/VOLTAGE/SPANNUNG/VOLTAGE/VOLTAJE

⚡ kW kcal/h
⚡ kw V~ Hz

PREZZO/PRICE
PREIS/PRIX/PRECIO
KG / M³



P-73/93-SX PORTA 300 SINISTRA
08430301 **EN** Left door 300 • **DE** Linke tür 300 • **FR** Porte gauche 300 • **ES**
Puerta izquierda 300
cm. 29,5x 2,5x 47,5h



197,00
3 / 0,01

P-74/94-SX PORTA 400 SINISTRA
08430401 **EN** Left door 400 • **DE** Linke tür 400 • **FR** Porte gauche 400 • **ES**
Puerta izquierda 400
cm. 39,5x 2,5x 47,5h

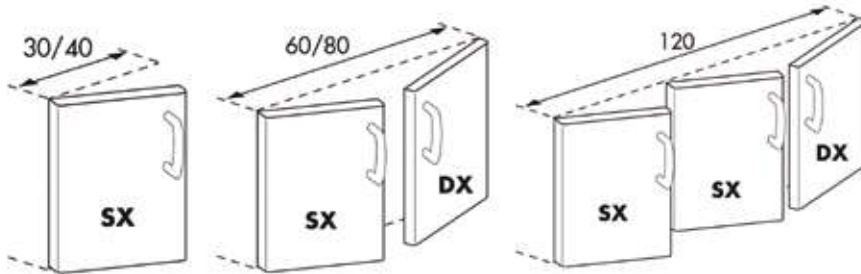

204,00
3.5 / 0,02

C-73/93 CASSETTIERA 300 N. 2 CASSETTI CON 2 BACINELLE INOX, GUIDE TELESCOPICHE. SOLO SU PL
08440320 **EN** Drawer set 300 N. 2 drawers with 2 inox containers, telescopic guides. Only for PL • **DE** Schubladen 300 - N. 2 Schubladen mit 2 Chromnickelstahlbehältern, Telescopeinführungen. Nur für PL • **FR** Tiroirs pour meuble de 300 N. 2 tiroirs avec 2 bacs inox, guides télescopiques. Seulement pour PL • **ES** Cajonera 300 - N. 2 cajones con 2 contenedores de acero inox, guías telescópicas. Solo para PL
cm. 29,5x 59x 47,5h



766,00
16 / 0,19

C-74/94 CASSETTIERA 400 - N. 2 CASSETTI CON 2 BACINELLE GN 1/1 15H IN PLASTICA, GUIDE TELESCOPICHE. SOLO SU PL
08440420 **EN** Drawer set 400 - N. 2 drawers with 2 GN 1/1 15h plastic containers, telescopic guides. Only for PL • **DE** Schubladen - N. 2 Schubladen mit 2 GN 1/1 15h Kunststoffbehältern, Telescopeinführungen. Nur für PL • **FR** Tiroirs pour meuble de 400 - N. 2 tiroirs avec 2 bacs en plastique GN 1/1 15h, guides télescopiques. Seulement pour PL • **ES** Cajonera 400 - N. 2 cajones con 2 contenedores GN 1/1 15h de plástico, guías telescópicas. Solo para PL
cm. 39,5x 59x 47,5h



786,00
18 / 0,19

C-76/96 CASSETTIERA 600 N. 2 CASSETTI CON 2 BACINELLE INOX, GUIDE TELESCOPICHE. SOLO SU PL
08440620 **EN** Drawer set 600 N. 2 drawers with 2 inox containers, telescopic guides. Only for PL • **DE** Schubladen 600 - N. 2 Schubladen mit 2 Chromnickelstahlbehältern, Telescopeinführungen. Nur für PL • **FR** Tiroirs pour meuble de 600 N. 2 tiroirs avec 2 bacs inox, guides télescopiques. Seulement pour PL • **ES** Cajonera 600 - N. 2 cajones con 2 contenedores de acero inox, guías telescópicas. Solo para PL
cm. 59,5x 59x 47,5h



1.086,00
22 / 0,28

C-78/98 CASSETTIERA 800 - N. 2 CASSETTI CON 4 BACINELLE GN 1/1 15H IN PLASTICA, GUIDE TELESCOPICHE. SOLO SU PL
08440820 **EN** Drawer set 800 - N. 2 drawers with 4 GN 1/1 15h plastic containers, telescopic guides. Only for PL • **DE** Schubladen 800 - N. 2 Schubladen mit 4 GN 1/1 15h Kunststoffbehältern, Telescopeinführungen. Nur für PL • **FR** Tiroirs pour meuble de 800 - N. 2 tiroirs avec 4 bacs en plastique GN 1/1 15h, guides télescopiques. Seulement pour PL • **ES** Cajonera 800 - N. 2 cajones con 4 contenedores GN 1/1 15h de plástico, guías telescópicas. Solo para PL
cm. 79,5x 59x 47,5h



1.105,00
26 / 0,37

ACCESSORI

MOD.
COD.

DESCRIZIONE/DESCRIPTION/BEZEICHNUNG/DESCRIPTION/DESCRIPCIÓN
DIMENSIONI/DIMENSIONS/ABMESSUNGEN/DIMENSIONS/DIMENSIONES

POTENZA/POWER/LEISTUNG/PUISSANCE/POTENCIA
VOLTAGGIO/VOLTAGE/SPANNUNG/VOLTAGE/VOLTAJE

↓ kW
kcal/h

↗ kW
V~
Hz

PREZZO/PRICE
PREIS/PRIX/PRECIO
KG / M³



SIA-7/9
08480000

STAFFA INFERIORE UNIONE APPARECCHI
EN Lower bracket to join two items

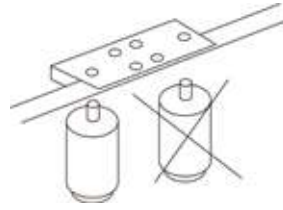

59,00
2 / 0,00

SR-100
50900001

SET 4 RUOTE Ø 100X30, 2 CON FRENO
EN Set of 4 wheels Ø 100x30, 2 with brake • **DE** 4 Rollen Satz Ø 100x30, 2 davon mit Feststellbremse • **FR** Kit 4 roues Ø 100x30, 2 avec frein • **ES** Equipo 4 ruedas Ø 100x30, 2 con frenos
cm. 12,7h



355,00
1 / 0,01

D-7
08470000

DIVISORIO
EN Spacer • **DE** Trennwand • **FR** Separation • **ES** Divisorio
cm. 5x 59x 45h

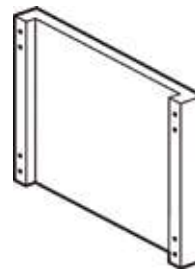

159,00
2.5 / 0,02

R-74
08450400

RIPIANO 400 SOLO PL
EN Shelf 400 Only for PL • **DE** Zwischenboden 400 Nur für PL • **FR** Étagère 400 Seulement pour PL • **ES** Estante 400 Solo para PL
cm. 35x 59x 2h

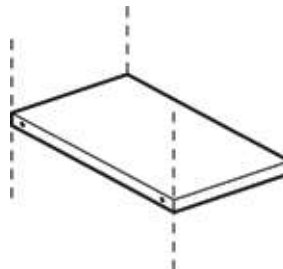

126,00
2 / 0,01

R-76
08450600

RIPIANO 600 SOLO PL
EN Shelf 600 Only for PL • **DE** Zwischenboden 600 Nur für PL • **FR** Étagère 600 Seulement pour PL • **ES** Estante 600 Solo para PL
cm. 55x 59x 2h

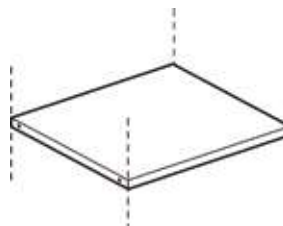

143,00
3 / 0,01

R-78
08450800

RIPIANO 800 SOLO PL
EN Shelf 800 Only for PL • **DE** Zwischenboden 800 Nur für PL • **FR** Étagère 800 Seulement pour PL • **ES** Estante 800 Solo para PL
cm. 75x 59x 2h



159,00
3.5 / 0,02

PT-74/94
08460002

PORTATEGLIE VANO 400/600 (GN-1/1) 4 RIPIANI INT. 7 CM.
EN Frame for plates 400/600 (GN-1/1) - N. 4 shelves, wheel-base 7 cm. • **DE** Aufhängeschienen für bleche 400/600 (GN-1/1) N. 4 Etagen, Abstand 7 cm. • **FR** Kit porte-plaques 400/600 (GN-1/1) - N. 4 étagères; 7 cm. • **ES** Portacazuelas 400/600 (GN-1/1) - N. 4 estantes, int. 7 cm.

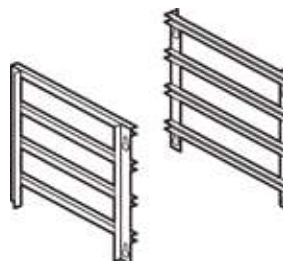

425,00
2.5 / 0,01

PT-78/98
08460012

PORTATEGLIE VANO 800 (GN-2/1) 4 RIPIANI INT. 7 CM.
EN Frame for plates 800 (GN-2/1) 4 Etagen, Abstand 7 cm. • **DE** Aufhängeschienen für bleche 800 (GN-2/1) N. 4 Etagen, Abstand 7 cm. • **FR** Kit porte-plaques 800 (GN-2/1) - N. 4 étagères; 7 cm. • **ES** Portacazuelas 800 (GN-2/1) - N. 4 estantes, int. 7 cm.

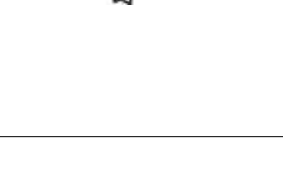

568,00
4 / 0,01

ACCESSORI BRASIERE

MOD. COD.	DESCRIZIONE/DESCRIPTION/BEZEICHNUNG/DESCRIPTION/DESCRIPCIÓN DIMENSIONI/DIMENSIONS/ABMESSUNGEN/DIMENSIONS/DIMENSIONES	POTENZA/POWER/LEISTUNG/PUISSANCE/POTENCIA VOLTAGGIO/VOLTAGE/SPANNUNG/VOLTAGE/VOLTAJE	⚡ kW kcal/h	⚡ kW V~ Hz	PREZZO/PRICE PREIS/PRIX/PRECIO KG / M ³
08550400	COPERCHIO BRF-74 EN Lid BRF-74 • DE Deckel BRF-74 • FR Couvercle BRF-74 • ES Tapa BRF-74 cm. 32x 53x 5h				143,00 2 / 0,02
08550800	COPERCHIO BRF-78 EN Lid BRF-78 • DE Deckel BRF-78 • FR Couvercle BRF-78 • ES Tapa BRF-78 cm. 72x 53x 5h				190,00 4 / 0,03
TG-4 07580400	TAGLIERE PLASTICA EN Plastic chopping-board • DE Schneidebrett • FR Plan de decoupe • ES Picador de plástico cm. 39x 58x 2,5h				157,00 6 / 0,01
TG-6 07580600	cm. 59x 58x 2,5h				232,00 9 / 0,02
TG-8 07580800	cm. 79x 58x 2,5h				300,00 11 / 0,02
CBTEST	"CB TEST CERTIFICATE" PER APPARECCHI: FT**-74/78/712ET**, PC/PCT/PCQ/PCQT-74/78/712ET, CF4/CFQ4-78ET, CF6/CQ6-712ET/ETV, F13/18-74ET, F2/13-78ET, F2/18-78ET, TP/TPT-78ET EN "CB TEST CERTIFICATE" for model: FT**-74/78/712ET**, PC/PCT/PCQ/PCQT-74/78/712ET, CF4/CFQ4-78ET, CF6/CQ6-712ET/ETV, F13/18-74ET, F2/13-78ET, F2/18-78ET, TP/TPT-78ET • DE "CB TEST CERTIFICATE" für modell: FT**-74/78/712ET**, PC/PCT/PCQ/PCQT-74/78/712ET, CF4/CFQ4-78ET, CF6/CQ6-712ET/ETV, F13/18-74ET, F2/13-78ET, F2/18-78ET, TP/TPT-78ET • FR "CB TEST CERTIFICATE" pour modèle: FT**-74/78/712ET**, PC/PCT/PCQ/PCQT-74/78/712ET, CF4/CFQ4-78ET, CF6/CQ6-712ET/ETV, F13/18-74ET, F2/13-78ET, F2/18-78ET, TP/TPT-78ET • ES "CB TEST CERTIFICATE" para modelo: FT**-74/78/712ET**, PC/PCT/PCQ/PCQT-74/78/712ET, CF4/CFQ4-78ET, CF6/CQ6-712ET/ETV, F13/18-74ET, F2/13-78ET, F2/18-78ET, TP/TPT-78ET				186,00 /
OPT-GA	ACCENSIONE ELETTRICA PER APPARECCHI GAS: PC-74GA, PC-78GA, PC-712GA, PC-716GA, PCT-74GA, PCT-78GA, PCT-712GA, PCT-716GA, CF6-712GAV, CF6-712GA, CF4-78GA - CF4-78GAE, CF6-712GAEV, CF6-712GAE, CFV4-78GAE, CFV6-712GAEV (PREZZO A BRUCIATORE) EN electric ignition for gas model: PC-74GA, PC-78GA, PC-712GA, PC-716GA, PCT-74GA, PCT-78GA, PCT-712GA, PCT-716GA, CF6-712GAV, CF6-712GA, CF4-78GA - CF4-78GAE, CF6-712GAEV, CF6-712GAE, CFV4-78GAE, CFV6-712GAEV (PRICE FOR 1 BURNER) • DE elektrische Zündung für gas modell: PC-74GA, PC-78GA, PC-712GA, PC-716GA, PCT-74GA, PCT-78GA, PCT-712GA, PCT-716GA, CF6-712GAV, CF6-712GA, CF4-78GA - CF4-78GAE, CF6-712GAEV, CF6-712GAE, CFV4-78GAE, CFV6-712GAEV (PREIS FÜR 1 BRENNER) • FR allumage électrique pour modèle a gaz: PC-74GA, PC-78GA, PC-712GA, PC-716GA, PCT-74GA, PCT-78GA, PCT-712GA, PCT-716GA, CF6-712GAV, CF6-712GA, CF4-78GA - CF4-78GAE, CF6-712GAEV, CF6-712GAE, CFV4-78GAE, CFV6-712GAEV (PRIX POUR 1 BRÛLEUR) • ES ignición eléctrica para modelo gas: PC-74GA, PC-78GA, PC-712GA, PC-716GA, PCT-74GA, PCT-78GA, PCT-712GA, PCT-716GA, CF6-712GAV, CF6-712GA, CF4-78GA - CF4-78GAE, CF6-712GAEV, CF6-712GAE, CFV4-78GAE, CFV6-712GAEV (PRECIO POR 1 QUEMADOR)			⚡ 0,01 kW 230V~ 50/60 Hz	250,00 /
532005901	GRIGLIA 1 FUOCO EN 1 flame grill • DE Rost 1 flamme • FR Frille 1 feu • ES Parilla 1 quemador				107,00 3 / 0,01

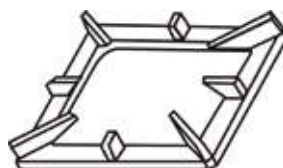
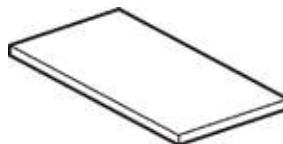

ACCESSORI

MOD. _____
COD. _____

DESCRIZIONE/DESCRIPTION/BEZEICHNUNG/DESCRIPTION/DESCRIPCIÓN
DIMENSIONI/DIMENSIONS/ABMESSUNGEN/DIMENSIONS/DIMENSIONES

POTENZA/POWER/LEISTUNG/PUISSANCE/POTENCIA
VOLTAGGIO/VOLTAGE/SPANNUNG/VOLTAGE/VOLTAJE

⚡ kW kcal/h
⚡ kw V~ Hz

PREZZO/PRICE
PREIS/PRIX/PRECIO
KG / M³



544439900 ANELLO PER WOK - SOLO PER GRIGLIE IN GHISA

EN Wok ring - only for cast iron grills • **DE** Wok Aufsatzring - nur für Roste aus Gusseisen • **FR** Anneau Wok - seulement pour grilles en fonte • **ES** Anillo Wok - solo para parrilas de hierro colado
cm. Ø22,5x 3,5h



157,00
2 / 0,00

KIT-WOK
09580040

KIT WOK - FIAMMA VERTICALE - SOLO SU BRUCIATORE DA 10 KW E GRIGLIE IN GHISA

EN KIT WOK - vertical flame - only for 10 kW burner and cast iron grills • **DE** KIT WOK - vertikaler Flamme - nur 10 kW-Brenner und Roste aus Gusseisen • **FR** KIT WOK - verticale de la flamme - seulement 10 kW brûleur et grilles en fonte • **ES** KIT WOK - llama vertical - sólo 10 kW quemador y parrilas de hierro colado
cm. Ø 26x 16h



422,00
5 / 0,02

PLF
07590401

PIASTRA LISCIA PER GRIGLIA IN GHISA

EN Smooth griddle plate for cast iron grid • **DE** Fortkochplatte glatt für Gusseisen Rost • **FR** Plaque lisse pour la grille en fonte • **ES** Plancha lisa para rejilla de hierro fundido
cm. 35x 27



190,00
9 / 0,01

PLF/2
07590421

PIASTRA LISCIA 2 FUOCHI PER GRIGLIA IN GHISA

EN Smooth griddle plate 2 burners for cast iron grid • **DE** Fortkochplatte glatt 2 Kochstellen für Gusseisen Rost • **FR** Plaque lisse 2 feux pour la grille en fonte • **ES** Plancha lisa 2 quemadores para rejilla de hierro fundido
cm. 35x 57



375,00
18 / 0,01

PRF
07590403

PIASTRA RIGATA PER GRIGLIA IN GHISA

EN Grooved griddle plate for cast iron grid • **DE** Fortkochplatte gerillt für Gusseisen Rost • **FR** Plaque nervurée pour la grille en fonte • **ES** Plancha estriada para rejilla de hierro fundido
cm. 35x 27



254,00
9 / 0,01

PRF/2
07590423

PIASTRA RIGATA 2 FUOCHI PER GRIGLIA IN GHISA

EN Grooved griddle plate 2 burners for cast iron grid • **DE** Fortkochplatte gerillt 2 Kochstellen für Gusseisen Rost • **FR** Plaque nervurée 2 feux pour la grille en fonte • **ES** Plancha estriada 2 quemadores para rejilla de hierro fundido
cm. 35x 57



417,00
18 / 0,01

PLFT/7
08590451

PIASTRA LISCIA PER GRIGLIA IN TONDINO

EN Smooth griddle plate for grid rod • **DE** Fortkochplatte glatt für Gitterstab • **FR** Plaque lisse pour tige grille • **ES** Plancha lisa por red de varilla
cm. 35x 27



190,00
9 / 0,01

PLFT/72
08590471

PIASTRA LISCIA 2 FUOCHI PER GRIGLIA IN TONDINO

EN Smooth griddle plate 2 burners for grid rod • **DE** Fortkochplatte glatt 2 Kochstellen für Gitterstab • **FR** Plaque lisse 2 feux pour tige grille • **ES** Plancha lisa 2 quemadores por red de varilla
cm. 35x 57



375,00
18 / 0,01

PRFT/7
08590453

PIASTRA RIGATA PER GRIGLIA IN TONDINO

EN Grooved griddle plate for grid rod • **DE** Fortkochplatte gerillt für Gitterstab • **FR** Plaque nervurée pour tige grille • **ES** Plancha estriada por red de varilla
cm. 35x 27

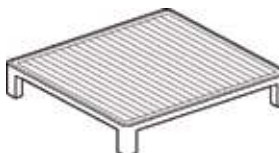

254,00
9 / 0,01

ACCESSORI

MOD.
COD.

DESCRIZIONE/DESCRIPTION/BEZEICHNUNG/DESCRIPTION/DESCRIPCIÓN
DIMENSIONI/DIMENSIONS/ABMESSUNGEN/DIMENSIONS/DIMENSIONES

POTENZA/POWER/LEISTUNG/PUISSANCE/POTENCIA
VOLTAGGIO/VOLTAGE/SPANNUNG/VOLTAGE/VOLTAJE

⚡ kW
kcal/h

⚡ kw
V~
Hz

PREZZO/PRICE
PREIS/PRIX/PRECIO
KG / M³



PRFT/72
08590473

PIASTRA RIGATA 2 FUOCHI PER GRIGLIA IN TONDINO
EN Grooved griddle plate 2 burners for grid rod • **DE** Fortkochplatte gerillt 2 Kochstellen für Gitterstab • **FR** Plaque nervurée 2 feux pour tige grille • **ES** Plancha estriada 2 quemadores por red de varilla
cm. 35x 57



417,00
18 / 0,01

533009200 **GRIGLIA DI RIDUZIONE**

EN Reduction • **DE** Reduzierstern • **FR** Grille de réduction • **ES** Rejilla de reducción
cm. 25x 25

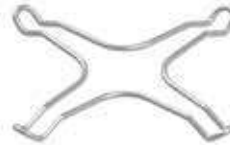

40,00
0.2 / 0,00

RV
08660410

RISCALDANTE VANO CUCINA
EN Heater for range's cabinet • **DE** Heizer für Herden-Schränkelement • **FR** Réchauffeur pour armoire du fourneau • **ES** Calefacción para armario neutro de la cocina
cm. 32x 48,5x 8h



⚡ 0,75 kW
230V~
50/60 Hz

903,00
8 / 0,08

RCRV-74
08450402

RIPIANO FORATO IN APPOGGIO PER RISCALDANTE SU VANO CUCINA
EN Perforated shelf for heater element mod.RV for cooker cabinet • **DE** regale Gelocht für Heizer mod.RV für Herden-Schränkelement • **FR** Étagère perforées pour réchauffeur mod.RV pour armoire du fourneau • **ES** estante perforado para elemento de calefacción mod.RV para armario neutro de la cocina
cm. 34x 55x 10h



351,00
5 / 0,03

RRV-74
08450401

RIPIANO FORATO IN APPOGGIO PER RISCALDANTE
EN Perforated shelf for heater element mod.RV • **DE** regale Gelocht für Heizer mod.RV • **FR** Étagère perforées pour réchauffeur mod.RV • **ES** estante perforado para elemento de calefacción mod.RV
cm. 34x 57x 10h

351,00
5 / 0,03

RRV-76
08450601

cm. 54x 57x 10h

539,00
7 / 0,04

RRV-78
08450801

cm. 74x 57x 10h

774,00
9 / 0,06

RRV-710
08451001

cm. 94x 57x 10h

970,00
11 / 0,08

RRV-712
08451201

cm. 114x 57x 10h

1.242,00
14 / 0,09

RRV-716
08451601

cm. 154x 57x 10h

1.581,00
18 / 0,12

08570401 **GRIGLIA TONDINO PER CW (SERIE 70)**

EN Grid for CW (70 line) • **DE** Gitter für CW (70. Serie) • **FR** Grille ronde pour CW (serie 70) • **ES** Rejilla para CW (serie 70)
cm. 36x 51x



421,00
11 / 0,03

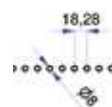

ACCESSORI GRIGLIE

MOD.
COD.

DESCRIZIONE/DESCRIPTION/BEZEICHNUNG/DESCRIPTION/DESCRIPCIÓN
DIMENSIONI/DIMENSIONS/ABMESSUNGEN/DIMENSIONS/DIMENSIONES

POTENZA/POWER/LEISTUNG/PUISSANCE/POTENCIA
VOLTAGGIO/VOLTAGE/SPANNUNG/VOLTAGE/VOLTAJE

⚡ kW kcal/h
⚡ kW V~ Hz

PREZZO/PRICE
PREIS/PRIX/PRECIO
KG / M³



08570402 GRIGLIA TEGOLO V PER CW (SERIE 70)
EN Grid V for CW (70 line) • **DE** Gitter V für CW (70. Serie) • **FR**
 Grille V pour CW (serie 70) • **ES** Rejilla V para CW (serie 70)
cm. 36x 51x

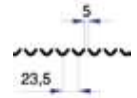

421,00
11 / 0,03

544023800 RASCHIETTO PER PIASTRA RIGATA
EN Scraper for gooved plate • **DE** Schaber für gerillte Kochplatte • **FR**
 Racloir pour plaque nervurée • **ES** Rasqueta para placa ranurada



64,00
/ 1,00

531040800 RASCHIETTO PER PIASTRA LISCIA AL CROMO LUCIDO
EN Scraper for smooth POLISHED CHROME plate • **DE** Schaber für
 glatte POLIERTEM CHROM Platte • **FR** Racloir pour plaque lisse au
 CHROME POLI • **ES** Rasqueta para placa lisa de CROMO PULIDO



58,00
/ 1,00

531040900 KIT 10 LAME PER RASCHIETTO COD.531040800
EN 10 blades kit for scraper cod.531040800 • **DE** Kit 10 klingen
 für Schaber cod.531040800 • **FR** Kit de 10 lames pour racloir
 cod.531040800 • **ES** Kit de 10 cuchillas para rasqueta cod.531040800

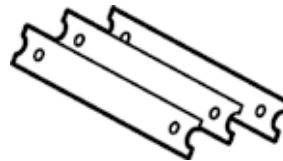

42,00
/ 0,00

T-FT 09580060 TAPPO PER FRY-TOP
EN stopper for Fry-top • **DE** Stopfen griddleplatte • **FR** bouchon pour
 Plaque • **ES** tapón Fry-top
cm. 10x 2x 5h



248,00
/ 0,00

PFT-74 08620400 KIT PROTEZIONE FRONTALE PIANO FRY-TOP
EN KIT front protection plan fry-top • **DE** Schutz-kit vorne Plan
 griddleplatte • **FR** KIT protection avant plan plaque • **ES** KIT de
 protección frontal plan de fry-top
cm. 35x 8x 6h

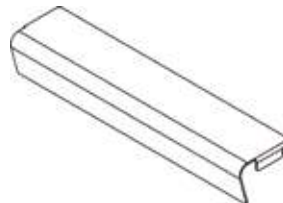

127,00
/ 0,00

PFT-76 08620600 **cm. 55x 8x 6h**

172,00
/ 0,01

PFT-78 08620800 **cm. 75x 8x 6h**

216,00
/ 0,01

PFT-712 08621200 **cm. 115x 8x 6h**

245,00
/ 0,01

ACCESSORI FRIGGITRICI

MOD. _____
COD. _____

DESCRIZIONE/DESCRIPTION/BEZEICHNUNG/DESCRIPTION/DESCRIPCIÓN
DIMENSIONI/DIMENSIONS/ABMESSUNGEN/DIMENSIONS/DIMENSIONES

POTENZA/POWER/LEISTUNG/PUISSANCE/POTENCIA
VOLTAGGIO/VOLTAGE/SPANNUNG/VOLTAGE/VOLTAJE

↓ kW kcal/h
↗ kw V~ Hz

PREZZO/PRICE
PREIS/PRIX/PRECIO
KG / M³



KF-F-ETD S70 KIT 100 FILTRI 5 MICRON PER F-ETDP S70

546003402 **EN** KIT 100 sieve 5 microns for F-ETDP S70 • **DE** KIT 100 Filter 5-Mikron für F-ETDP S70 • **FR** KIT 100 filtre 5 microns pour F-ETDP S70 • **ES** KIT 100 filtro de 5 micrones para F-ETDP S70



401,00
0.1 / 0,00

531013200 CESTINO 1/2 PER F13-G/E

EN Basket 1/2 for F13-G/E • **DE** Korb 1/2 für F13-G/E • **FR** Panier 1/2 pour F13-G/E • **ES** Cesta 1/2 para F13-G/E
cm. 10x 30x 12h



58,00
0.7 / 0,03

531013500 CESTINO 1/2 PER F18-70G

EN Basket 1/2 for F18-70G • **DE** Korb 1/2 für F18-70G • **FR** Panier 1/2 pour F18-70G • **ES** Cesta 1/2 para F18-70G
cm. 14x 33x 12h



71,00
0.8 / 0,04

531041600 CESTINO 1/2 PER F18-E (STANDARD IN F18-ETD)

EN Basket 1/2 for F18-E (standard F18-ETD) • **DE** Korb 1/2 zur Friteuse F18-E (standard F18-ETD) • **FR** Panier 1/2 pour F18-E (standard F18-ETD) • **ES** Cesta 1/2 para F18-E (standard F18-ETD)
cm. 13,5x 29x 15h



78,00
0.8 / 0,04

531033300 CESTINO 1/1 F45

EN Basket 1/1 F45 • **DE** korb 1/1 F45 • **FR** Panier 1/1 F45 • **ES** Cesta 1/1 F45
cm. 65x 33x 17h

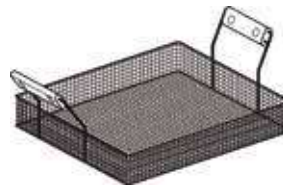

203,00
3 / 0,10

531041300 CESTINO 1/2 F45, 1/1 PER F18-ETD (STANDARD IN F18-E)

EN Basket 1/2 F45, 1/1 for F18-ETD (standard F18-E) • **DE** korb 1/2 F45, 1/1 für F18-ETD (standard F18-E) • **FR** Panier 1/2 F45, 1/1 pour F18-ETD (standard F18-E) • **ES** Cesta 1/2 F45, 1/1 para F18-ETD (standard F18-E)
cm. 28x 29x 15h



84,00
1.5 / 0,06

531047800 CESTINO 1/3 F45

EN Basket 1/3 F45 • **DE** korb 1/3 F45 • **FR** Panier 1/3 F45 • **ES** Cesta 1/3 F45
cm. 21,5x 33x 16,5h



99,00
1.3 / 0,06

40280800 SCIVOLO INOX F45

EN Stainless steel slide F45 • **DE** Rutsche aus Rostfreiem Stahl F45 • **FR** Goulotte en acier inox F45 • **ES** Deslizador inox F45
cm. 38x 75x 27h

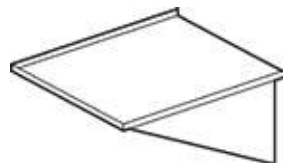

157,00
5 / 0,09

ACCESSORI CUOCIPASTA

MOD. _____
COD. _____

DESCRIZIONE/DESCRIPTION/BEZEICHNUNG/DESCRIPTION/DESCRIPCIÓN
DIMENSIONI/DIMENSIONS/ABMESSUNGEN/DIMENSIONS/DIMENSIONES

POTENZA/POWER/LEISTUNG/PUISSANCE/POTENCIA
VOLTAGGIO/VOLTAGE/SPANNUNG/VOLTAGE/VOLTAJE

⚡ kW kcal/h
⚡ kW V~ Hz

PREZZO/PRICE
PREIS/PRIX/PRECIO
KG / M³



531070200 CESTO 1/1 PER CP-74/78

EN Basket 1/1 for CP-74/78 • DE Korb 1/1 für CP-74/78 • FR
Panier 1/1 pour CP-74/78 • ES Cesta 1/1 para CP-74/78
cm. 28x 32x 21,5h

171,00
2 / 0,06



531032400 CESTO 1/2 PER CP-74/78

EN Basket 1/2 for CP-74/78 • DE Korb 1/2 für CP-74/78 • FR
Panier 1/2 pour CP-74/78 • ES Cesta 1/2 para CP-74/78
cm. 14x 32x 20h

118,00
1.5 / 0,05

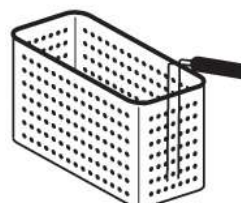

..324..

531047900 cm. 28x 16x 21,5h

123,00
1.5 / 0,04



531048000 CESTO 1/4 PER CP-74/78

EN Basket 1/4 for CP-74/78 • DE Korb 1/4 für CP-74/78 • FR
Panier 1/4 pour CP-74/78 • ES Cesta 1/4 para CP-74/78
cm. 13,5x 16x 21,5h

94,00
1 / 0,02



531032600 CESTO 1/6 PER CP-74/78

EN Basket 1/6 for CP-74/78 • DE Korb 1/6 für CP-74/78 • FR
Panier 1/6 pour CP-74/78 • ES Cesta 1/6 para CP-74/78
cm. 14x 10x 20h

83,00
0.7 / 0,02

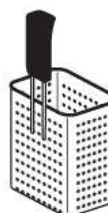

..326..

531053900 CESTO 1/1 PER CP-76

EN Basket 1/1 for CP-76 • DE Korb 1/1 für CP-76 • FR Panier 1/1
pour CP-76 • ES Cesta 1/1 para CP-76
cm. 49x 29x 20h

183,00
3,5 / 0,08

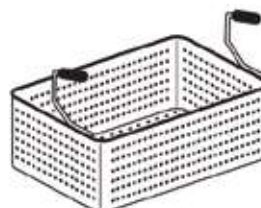

..539..

ACCESSORI CUOCIPASTA

MOD. _____
COD. _____

DESCRIZIONE/DESCRIPTION/BEZEICHNUNG/DESCRIPTION/DESCRIPCIÓN
DIMENSIONI/DIMENSIONS/ABMESSUNGEN/DIMENSIONS/DIMENSIONES

POTENZA/POWER/LEISTUNG/PUISSANCE/POTENCIA
VOLTAGGIO/VOLTAGE/SPANNUNG/VOLTAGE/VOLTAJE

⚡ kW kcal/h ⚡ kw V~ Hz

PREZZO/PRICE
PREIS/PRIX/PRECIO
KG / M³



531017900 CESTO 1/3 PER CP-76

EN Basket 1/3 for CP-76 • **DE** Korb 1/3 für CP-76 • **FR** Panier 1/3 pour CP-76 • **ES** Cesta 1/3 para CP-76
cm. 16x 29x 20h

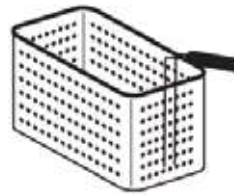

..179..

134,00
1,5 / 0,05

531064300 CESTO 1/4 PER CP-76

EN Basket 1/4 for CP-76 • **DE** Korb 1/4 für CP-76 • **FR** Panier 1/4 pour CP-76 • **ES** Cesta 1/4 para CP-76
cm. 11,5x 29x 20h

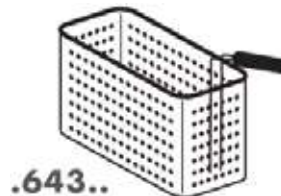

.643..

120,00
1,2 / 0,04

531071100 CESTO CON GANCIO 1/2 PER CP-74/78

EN Basket with hook 1/2 for CP-74/78 • **DE** Korb mit Haken 1/2 für CP-74/78 • **FR** Panier avec crochet 1/2 pour CP-74/78 • **ES** Cesta con gancho 1/2 para CP-74/78
cm. 14,5x 29x 20h



166,00
1.5 / 0,05

531071200 CESTO CON GANCIO 1/3 PER CP-76

EN Basket with hook 1/3 for CP-76 • **DE** Korb mit Haken 1/3 für CP-76 • **FR** Panier avec crochet 1/3 pour CP-76 • **ES** Cesta con gancho 1/3 para CP-76
cm. 15x 26x 20h



146,00
1,5 / 0,05

531018700 CESTO CON GANCIO 1/4 PER CP-76

EN Basket with hook 1/4 for CP-76 • **DE** Korb mit Haken 1/4 für CP-76 • **FR** Panier avec crochet 1/4 pour CP-76 • **ES** Cesta con gancho 1/4 para CP-76
cm. 11x 26x 20h

531069300 GRIGLIA SUPPORTO CESTI CON GANCIO PER CP-74/78

EN support for baskets with hook for CP-74/78 • **DE** Unterstützung für Körbe mit Haken für CP-74/78 • **FR** soutien pour les paniers avec crochet pour CP-74/78 • **ES** soporte para cestas con gancho para CP-74/78
cm. 30x 33x 41h



141,00
3.5 / 0,06

531069400 GRIGLIA SUPPORTO CESTI CON GANCIO PER CP-76

EN support for baskets with hook for CP-76 • **DE** Unterstützung für Körbe mit Haken für CP-76 • **FR** soutien pour les paniers avec crochet pour CP-76 • **ES** soporte para cestas con gancho para CP-76
cm. 50x 29x 41h



181,00
4 / 0,09

ACCESSORI

MOD. _____
COD. _____

DESCRIZIONE/DESCRIPTION/BEZEICHNUNG/DESCRIPTION/DESCRIPCIÓN
DIMENSIONI/DIMENSIONS/ABMESSUNGEN/DIMENSIONS/DIMENSIONES

POTENZA/POWER/LEISTUNG/PUISSANCE/POTENCIA
VOLTAGGIO/VOLTAGE/SPANNUNG/VOLTAGE/VOLTAJE

↓ kW kcal/h
↗ kW V~ Hz

PREZZO/PRICE
PREIS/PRIX/PRECIO
KG / M³



SA-72/92 08600200	SCHIENA POSTERIORE A VISTA PER APPARECCHI EN Back cover • DE Ruckenwand • FR Dos de finition • ES panel posterior cm. 20x 1,5x 81h		104,00 2 / 0,01
SA-73/93 08600300	cm. 30x 1,5x 81h		118,00 3 / 0,01
SA-74/94 08600400	cm. 40x 1,5x 81h		135,00 3 / 0,01
SA-75/95 08600500	cm. 50x 1,5x 81h		170,00 4 / 0,01
SA-76/96 08600600	cm. 60x 1,5x 81h		196,00 4 / 0,02
SA-77/97 08600700	cm. 70x 1,5x 81h		208,00 5 / 0,02
SA-78/98 08600800	cm. 80x 1,5x 81h		229,00 5 / 0,02
SA-79/99 08600900	cm. 90x 1,5x 81h		257,00 6 / 0,02
SA-710/910 08601000	cm. 100x 1,5x 81h		285,00 6 / 0,03
SA-711/911 08601100	cm. 110x 1,5x 81h		316,00 7 / 0,03
SA-712/912 08601200	cm. 120x 1,5x 81h		344,00 7 / 0,03
SA-713/913 08601300	cm. 130x 1,5x 81h		373,00 8 / 0,03
SA-714/914 08601400	cm. 140x 1,5x 81h		400,00 8 / 0,04
SA-715/915 08601500	cm. 150x 1,5x 81h		428,00 10 / 0,04
SA-716/916 08601600	cm. 160x 1,5x 81h		456,00 10 / 0,04
SA-74FG 08600401	SCHIENA POSTERIORE A VISTA PER FRIGGITRICI GAS (NO F2/8-74G) EN Back cover for Gas Fryer (no F2/8-74G) • DE Ruckenwand fur Gas-Friteuse (no F2/8-74G) • FR Dos de finition pour Friteuse a gaz (no F2/8-74G) • ES panel posterior para Freidoras a gas (no F2/8-74G) cm. 40x 1,5x 94h		156,00 3 / 0,01
SA-78FG 08600801	SCHIENA POSTERIORE A VISTA PER FRIGGITRICI GAS EN Back cover for Gas Fryer • DE Ruckenwand fur Gas-Friteuse • FR Dos de finition pour Friteuse a gaz • ES panel posterior para Freidoras a gas cm. 80x 1,5x 94h		249,00 5 / 0,02
SA-78F45G 08600803	SCHIENA POSTERIORE A VISTA PER FRIGGITRICE GAS F45-78G EN Back cover for Gas Fryer F45-78G • DE Ruckenwand fur Gas-Friteuse F45-78G • FR Dos de finition pour Friteuse a gaz F45-78G • ES panel posterior para Freidoras a gas F45-78G cm. 80x 1,5x 121h		259,00 6 / 0,03

MOD. _____
COD. _____

DESCRIZIONE/DESCRIPTION/BEZEICHNUNG/DESCRIPTION/DESCRIPCIÓN
DIMENSIONI/DIMENSIONS/ABMESSUNGEN/DIMENSIONS/DIMENSIONES

POTENZA/POWER/LEISTUNG/PUISSANCE/POTENCIA
VOLTAGGIO/VOLTAGE/SPANNUNG/VOLTAGE/VOLTAJE

⚡ kW kcal/h
⚡ kw V~ Hz

PREZZO/PRICE
PREIS/PRIX/PRECIO
KG / M³



KIT-TOPM-SA KIT TAMPONAMENTI LATERALI PER SCHIENA POSTERIORE MONTATA SU APPARECCHI TOP E MOBILI "M-.."

08560001

EN Side KIT for back cover mounted on the TOP machine and Stand "M-.."
DE Seitliches KIT für Rückenwand montiert auf der TOP-Maschine und Unterbau "M-.."
FR KIT latéral pour Dos de finition monté sur la machine TOP et Placard "M-.."
ES KIT lateral para panel posteriore montado en la máquina TOP y Mueble base "M-.."

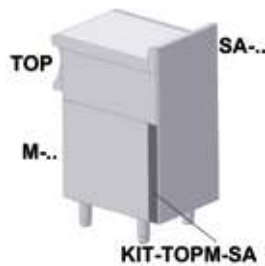

92,00
1 / 0,01

TPA-7 TESTATA CHIUSURA PIANO (IN DOTAZIONE 1 PEZZO PER APPARECCHIO)

08560001

EN Head end filler strip (1 piece included in each machine)
DE Abschluss-Element (1 Stück in jeder Maschine enthalten)
FR Élément de jonction top (1 pièce incluse dans chaque machine)
ES Chapa de cierre para top (1 pieza incluida en cada equipo)
cm. 0,2x 70,5



71,00
1 / 0,00

TMA-7SX TESTATA 1 LATO SERIE 70 SINISTRA

08540701

EN Head 1 side S70 left
DE Abschluss element 1 seite S70 links
FR Element de jonction 1 coté S70 gauche
ES Embellecedor 1 lado S70 izquierda
cm. 0,2x 70,5



259,00
8 / 1,00

TMA-7DX TESTATA 1 LATO SERIE 70 DESTRA

08540700

EN Head 1 side S70 right
DE Abschluss element 1 seite S70 recht
FR Element de jonction 1 coté S70 droit
ES Embellecedor 1 lado S70 derecha
cm. 0,2x 70,5



259,00
8 / 1,00

TMA-77 TESTATA 2 LATI SERIE 70

08547700

EN Head 2 sides S70
DE Abschluss element seiten S70
FR Element de jonction 2 cotés S70
ES Embellecedor 2 lados S70
cm. 0,2x 141



520,00
16 / 1,00

TMA-79SX TESTATA 2 LATI SERIE 70/90 SINISTRA

08547901

EN Head 2 sides S70/90 left
DE Abschluss element seiten S70/90 links
FR Element de jonction 2 cotés S70/90 gauche
ES Embellecedor 2 lados S70/90 izquierda
cm. 0,2x160,5



532,00
18 / 1,00

ACCESSORI

MOD. _____
COD. _____

DESCRIZIONE/DESCRIPTION/BEZEICHNUNG/DESCRIPTION/DESCRIPCIÓN
DIMENSIONI/DIMENSIONS/ABMESSUNGEN/DIMENSIONS/DIMENSIONES

POTENZA/POWER/LEISTUNG/PUISSANCE/POTENCIA
VOLTAGGIO/VOLTAGE/SPANNUNG/VOLTAGE/VOLTAJE

⚡ kW kcal/h
⚡ kw V~ Hz

PREZZO/PRICE
PREIS/PRIX/PRECIO
KG / M³



TMA-79DX
08547900

TESTATA 2 LATI SERIE 70/90 DESTRA

EN Head 2 sides S70/90 right • **DE** Abschluss element seiten S70/90 recht • **FR** Element de jonction 2 cotés S70/90 droit • **ES** Embellecedor 2 lados S70/90 derecha
cm. 0,2x160,5



532,00
18 / 1,00

TMTA-7SX
08540721

TESTATA TAMBURATA 1 LATO SERIE 70 SINISTRA, CON STESSO PROFILO LINEA FRONTALE

EN Head 1 side S70 left, with the same front line profile • **DE** Abschluss element 1 seite S70 links, mit dem gleichen Frontlinienprofil • **FR** Element de jonction 1 coté S70 gauche, avec le même profil de ligne • **ES** Embellecedor 1 lado S70 izquierda, con el mismo perfil de línea frontal
cm. 7,5x 70,5



816,00
14 / 0,16

TMTA-7DX
08540720

TESTATA TAMBURATA 1 LATO SERIE 70 DESTRA, CON STESSO PROFILO LINEA FRONTALE

EN Head 1 side S70 right, with the same front line profile • **DE** Abschluss element 1 seite S70 recht, mit dem gleichen Frontlinienprofil • **FR** Element de jonction 1 coté S70 droit, avec le même profil de ligne • **ES** Embellecedor 1 lado S70 derecha, con el mismo perfil de línea frontal
cm. 7,5x 70,5



816,00
14 / 0,16

TMTA-77
08547720

TESTATA TAMBURATA 2 LATI SERIE 70, CON STESSO PROFILO LINEA FRONTALE

EN Head 2 sides S70, with the same front line profile • **DE** Abschluss element seiten S70, mit dem gleichen Frontlinienprofil • **FR** Element de jonction 2 cotés S70, avec le même profil de ligne • **ES** Embellecedor 2 lados S70, con el mismo perfil de línea frontal
cm. 7,5x 141



1.579,00
28 / 0,30

TMTA-79SX
08547921

TESTATA TAMBURATA 2 LATI SERIE 70/90 SINISTRA, CON STESSO PROFILO LINEA FRONTALE

EN Head 2 sides S70/90 left, with the same front line profile • **DE** Abschluss element seiten S70/90 links, mit dem gleichen Frontlinienprofil • **FR** Element de jonction 2 cotés S70/90 gauche, avec le même profil de ligne • **ES** Embellecedor 2 lados S70/90 izquierda, con el mismo perfil de línea frontal
cm. 7,5x160,5



1.604,00
30 / 0,34

TMTA-79DX
08547920

TESTATA TAMBURATA 2 LATI SERIE 70/90 DESTRA, CON STESSO PROFILO LINEA FRONTALE

EN Head 2 sides S70/90 right, with the same front line profile • **DE** Abschluss element seiten S70/90 recht, mit dem gleichen Frontlinienprofil • **FR** Element de jonction 2 cotés S70/90 droit, avec le même profil de ligne • **ES** Embellecedor 2 lados S70/90 derecha, con el mismo perfil de línea frontal
cm. 7,5x160,5



1.604,00
30 / 0,34

ACCESSORI

MOD. _____
COD. _____

DESCRIZIONE/DESCRIPTION/BEZEICHNUNG/DESCRIPTION/DESCRIPCIÓN
DIMENSIONI/DIMENSIONS/ABMESSUNGEN/DIMENSIONS/DIMENSIONES

POTENZA/POWER/LEISTUNG/PUISSANCE/POTENCIA
VOLTAGGIO/VOLTAGE/SPANNUNG/VOLTAGE/VOLTAJE

$\frac{kW}{kcal/h}$ $\frac{V}{Hz}$

PREZZO/PRICE
PREIS/PRIX/PRECIO
KG / M³



MOD. / COD.	DESCRIZIONE / DESCRIPTION / BEZEICHNUNG / DESCRIPTION / DESCRIPCIÓN	POTENZA / POWER / LEISTUNG / PUISSANCE / POTENCIA VOLTAGGIO / VOLTAGE / SPANNUNG / VOLTAGE / VOLTAJE	$\frac{kW}{kcal/h}$ $\frac{V}{Hz}$	PREZZO / PRICE PREIS / PRIX / PRECIO KG / M ³
TSP-4 18400400	COPPIA TRAVERSE SUPPORTO PONTE EN Support for bridge type system • DE Bruckengestell • FR Support en pont cm. 40x 6x 6			216,00 / 0,01
TSP-6 18400600	cm. 60x 6x 6			243,00 / 0,01
TSP-8 18400800	cm. 80x 6x 6			272,00 / 0,01
TSP-10 18401000	cm. 100x 6x 6			302,00 / 0,02
TSP-12 18401200	cm. 120x 6x 6			328,00 / 0,02
TSP-14 18401400	cm. 140x 6x 6			356,00 / 0,02
TSP-16 18401600	cm. 160x 6x 6			379,00 / 0,03
TSP-18 18401800	cm. 180x 6x 6			416,00 / 0,03
TSP-20 18402000	cm. 200x 6x 6			436,00 / 0,03



09610800	MITRA 800 EN Chimney jack 800 • DE Lüftungsaufsatz 800 • FR Mitre 800 • ES Caperuza 800 cm. 80x 7x 92h			585,00 16 / 0,04
09611200	MITRA 1200 EN Chimney jack 1200 • DE Lüftungsaufsatz 1200 • FR Mitre 1200 • ES Caperuza 1200 cm. 120x 7x 92h			782,00 24 / 0,06
08610802	MITRA 800 PER F45-78G EN Chimney jack 800 • DE Lüftungsaufsatz 800 • FR Mitre 800 • ES Caperuza 800 cm. 80x 7x 52h			585,00 16 / 0,04

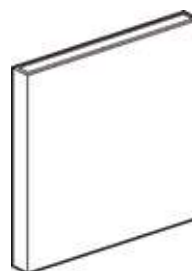

09610801	CAMINO ANTIVENTO 800 EN Draught diverter 800 • DE Strömungssicherung 800 • FR Cheminee anti-vent 800 • ES Chimenea contra viento 800 cm. 80x 19x 120h			823,00 16 / 0,15
09611201	CAMINO ANTIVENTO 1200 EN Draught diverter 1200 • DE Strömungssicherung 1200 • FR Cheminee anti-vent 1200 • ES Chimenea contra viento 1200 cm. 120x 19x 120h			1.086,00 24 / 0,25
08610803	CAMINO ANTIVENTO 800 PER F45-78G EN Draught diverter 800 for F45-78G • DE Strömungssicherung 800 für F45-78G • FR Cheminee anti-vent 800 pour F45-78G • ES Chimenea contra viento 800 para F45-78G cm. 80x 19x 77h			823,00 16 / 0,15

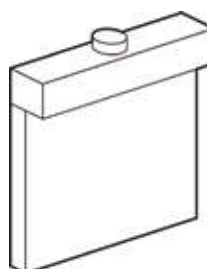

ACCESSORI

MOD. _____
COD. _____

DESCRIZIONE/DESCRIPTION/BEZEICHNUNG/DESCRIPTION/DESCRIPCIÓN
DIMENSIONI/DIMENSIONS/ABMESSUNGEN/DIMENSIONS/DIMENSIONES

POTENZA/POWER/LEISTUNG/PUISSANCE/POTENCIA
VOLTAGGIO/VOLTAGE/SPANNUNG/VOLTAGE/VOLTAJE

$\frac{kW}{kcal/h}$ $\frac{kW}{V \sim}$
Hz

PREZZO/PRICE
PREIS/PRIX/PRECIO
KG / M³



08570103 MENSOLA ANTERIORE
EN Earlier shelf • **DE** Frühere Regal • **FR** Plus tôt plateau • **ES** A
principios de la plataforma
cm. 30x 21x 5h



406,00
/ 0,01

08570104 cm. 40x 21x 5h

418,00
/ 0,01

08570105 cm. 50x 21x 5h

430,00
/ 0,01

08570106 cm. 60x 21x 5h

442,00
/ 0,01

08570107 cm. 70x 21x 5h

452,00
/ 0,01

08570108 cm. 80x 21x 5h

463,00
/ 0,01

08570109 cm. 90x 21x 5h

476,00
/ 0,02

08570110 cm. 100x 21x 5h

487,00
/ 0,02

08570111 cm. 110x 21x 5h

501,00
/ 0,02

08570112 cm. 120x 21x 5h

514,00
/ 0,02

08570113 cm. 130x 21x 5h

531,00
/ 0,02

08570114 cm. 140x 21x 5h

543,00
/ 0,02

08570115 cm. 150x 21x 5h

560,00
/ 0,02

08570116 cm. 160x 21x 5h

576,00
/ 0,03

ACCESSORI

MOD. _____
COD. _____

DESCRIZIONE/DESCRIPTION/BEZEICHNUNG/DESCRIPTION/DESCRIPCIÓN
DIMENSIONI/DIMENSIONS/ABMESSUNGEN/DIMENSIONS/DIMENSIONES

POTENZA/POWER/LEISTUNG/PUISSANCE/POTENCIA
VOLTAGGIO/VOLTAGE/SPANNUNG/VOLTAGE/VOLTAJE

⚡ kW kcal/h
⚡ kw V~ Hz

PREZZO/PRICE
PREIS/PRIX/PRECIO
KG / M³



MOD. / COD.	DESCRIZIONE/DESCRIPTION/BEZEICHNUNG/DESCRIPTION/DESCRIPCIÓN DIMENSIONI/DIMENSIONS/ABMESSUNGEN/DIMENSIONS/DIMENSIONES	POTENZA/POWER/LEISTUNG/PUISSANCE/POTENCIA VOLTAGGIO/VOLTAGE/SPANNUNG/VOLTAGE/VOLTAJE	⚡ kW kcal/h ⚡ kw V~ Hz	PREZZO/PRICE PREIS/PRIX/PRECIO KG / M ³
08570002	CORRIMANO EN Handrail • DE Hand Lauf • FR Main courante • ES Pasamano cm. 20x 7x 4h			341,00 / 0,00
08570003	cm. 30x 7x 4h			346,00 / 0,00
08570004	cm. 40x 7x 4h			350,00 / 0,00
08570005	cm. 50x 7x 4h			359,00 / 0,00
08570006	cm. 60x 7x 4h			371,00 / 0,00
08570007	cm. 70x 7x 4h			377,00 / 0,00
08570008	cm. 80x 7x 4h			383,00 / 0,01
08570009	cm. 90x 7x 4h			389,00 / 0,01
08570010	cm. 100x 7x 4h			395,00 / 0,01
08570011	cm. 110x 7x 4h			406,00 / 0,01
08570012	cm. 120x 7x 4h			418,00 / 0,01
08570013	cm. 130x 7x 4h			431,00 / 0,01
08570014	cm. 140x 7x 4h			446,00 / 0,01
08570015	cm. 150x 7x 4h			486,00 / 0,01
08570016	cm. 160x 7x 4h			526,00 / 0,01



533116300	GIUNZIONE CORRIMANO EN junction handrail • DE Gelenk Hand lauf • FR Main courante de l'embranchement • ES conexión pasamano cm. Ø 3x 2,4			54,00 / 1,00
-----------	---	--	--	------------------------

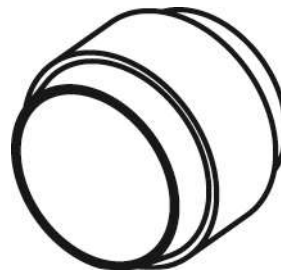

ACCESSORI

MOD. _____
COD. _____

DESCRIZIONE/DESCRIPTION/BEZEICHNUNG/DESCRIPTION/DESCRIPCIÓN
DIMENSIONI/DIMENSIONS/ABMESSUNGEN/DIMENSIONS/DIMENSIONES

POTENZA/POWER/LEISTUNG/PUISSANCE/POTENCIA
VOLTAGGIO/VOLTAGE/SPANNUNG/VOLTAGE/VOLTAJE

⚡ kW kcal/h
⚡ kw V~ Hz

PREZZO/PRICE
PREIS/PRIX/PRECIO
KG / M³



ZB
01410000

ZOCCOLATURA BASE
EN FRONT PLINTH • **DE** GRUNDSOCKEL • **FR** PLINTHE FRONTAL
• **ES** ZOCOLOS BASE
€/m x cm. 15h

143,00
/

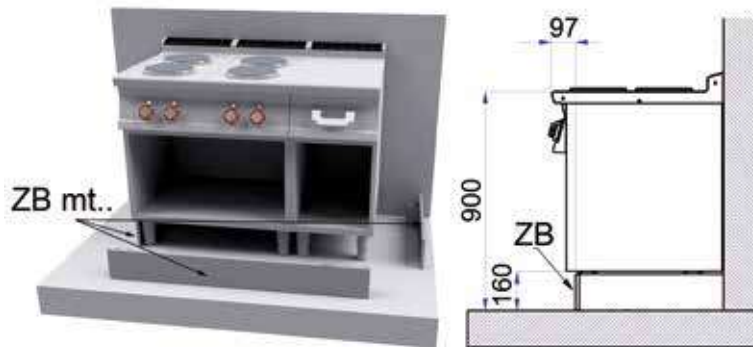

FZ-7
08480001

ZOCCOLATURA LATERALE - KIT
EN side plinth - kit • **DE** seitensockel - kit • **FR** plinthe lateral - kit
• **ES** zocolos lateral - kit
cm. 1,5x 61x 6h

294,00
/ 0,02



CZ-72/92
08480002

KIT CASSETTO ZOCCOLO, INCLUSI 4 PIEDINI
EN drawer clog - kit (4 small feet included) • **DE** schubladen sockel - kit
(4 kleine FüÙe enthalten) • **FR** tiroir plinthe - kit (4 petits pieds inclus)
• **ES** cajon zocolos - kit (4 pies pequeno incluido)
cm. 20x 61x 5,5h

172,00
3 / 0,01



CZ-73
08480003

cm. 30x 61x 5,5h

200,00
3.5 / 0,02

CZ-74
08480004

cm. 40x 61x 5,5h

229,00
4 / 0,02

CZ-76
08480006

cm. 60x 61x 5,5h

302,00
5 / 0,03

CZ-78
08480008

cm. 80x 61x 5,5h

378,00
7 / 0,04

CZ-712
08480012

cm. 120x 61x 5,5h

528,00
8 / 0,06

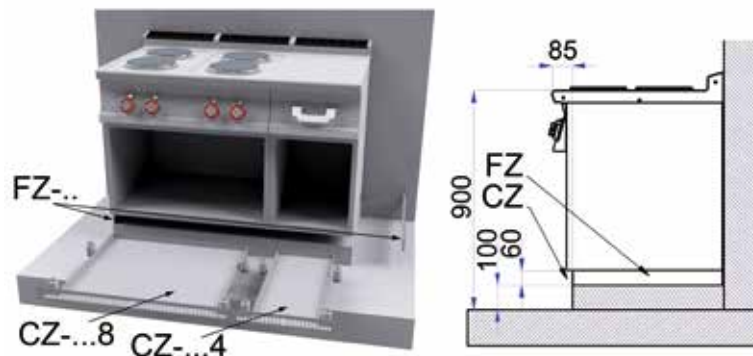

PIANI LAVORO - TOP

MOD. _____
COD. _____

DESCRIZIONE/DESCRIPTION/BEZEICHNUNG/DESCRIPTION/DESCRIPCIÓN
DIMENSIONI/DIMENSIONS/ABMESSUNGEN/DIMENSIONS/DIMENSIONES

POTENZA/POWER/LEISTUNG/PUISSANCE/POTENCIA
VOLTAGGIO/VOLTAGE/SPANNUNG/VOLTAGE/VOLTAJE

⚡ kW kcal/h
⚡ kw V~ Hz

PREZZO/PRICE
PREIS/PRIX/PRECIO
KG / M³



PLT-72
18010200

PIANO LAVORO (INCLUSA 1 TESTATA CHIUSURA PIANO MOD.TPA-7)

EN Worktop (included 1 Head end filler strip mod.TPA-7) • **DE** Arbeitsplatte (inbegriffen 1 Abschluss-Element mod.TPA-7) • **FR** Plan de travail (inclus 1 Élément de jonction top mod.TPA-7) • **ES** Sobre de trabajo (incluida 1 Chapa de cierre para top mod.TPA-7)
cm. 20x 70,5x 28h



566,00
15 / 0,18

PLST-73
18010301

cm. 30x 70,5x 28h



604,00
20 / 0,18

PLST-74
18010401

cm. 40x 70,5x 28h



620,00
22 / 0,18

PLST-76
18010601

cm. 60x 70,5x 28h



808,00
27 / 0,26

PLST-78
18010801

cm. 80x 70,5x 28h



920,00
33 / 0,35

PLT-73
18010300

PIANO LAVORO CASSETTO CON 1 BACINELLA: CM. 19X50X15H INOX (INCLUSA 1 TESTATA CHIUSURA PIANO MOD.TPA-7)

EN Worktop Drawer with 1 container: cm. 19x50x15h inox (included 1 Head end filler strip mod.TPA-7) • **DE** Arbeitsplatte Schublade mit 1 Behälter: cm. 19x50x15h inox (inbegriffen 1 Abschluss-Element mod.TPA-7) • **FR** Plan de travail Tiroir avec 1 bac: cm. 19x50x15h inox (inclus 1 Élément de jonction top mod.TPA-7) • **ES** Sobre de trabajo Cajón con 1 contenedore: cm. 19x50x15h inox (incluida 1 Chapa de cierre para top mod.TPA-7)
cm. 30x 70,5x 28h



866,00
23 / 0,18

PIANI LAVORO - TOP

MOD. _____
COD. _____

DESCRIZIONE/DESCRIPTION/BEZEICHNUNG/DESCRIPTION/DESCRIPCIÓN
DIMENSIONI/DIMENSIONS/ABMESSUNGEN/DIMENSIONS/DIMENSIONES

POTENZA/POWER/LEISTUNG/PUISSANCE/POTENCIA
VOLTAGGIO/VOLTAGE/SPANNUNG/VOLTAGE/VOLTAJE

⚡ kW kcal/h
⚡ kW V~ Hz

PREZZO/PRICE
PREIS/PRIX/PRECIO
KG / M³



PLT-74
18010400

PIANO LAVORO CASSETTO CON 1 BACINELLA GN 1/1 15H PLASTICA (INCLUSA 1 TESTATA CHIUSURA PIANO MOD. TPA-7)

EN Worktop - Drawer with 1 plastic container GN 1/1 15h (included 1 Head end filler strip mod.TPA-7) • **DE** Arbeitsplatte - Schublade mit 1 GN 1/1 15h Kunststoffbehälter (inbegriffen 1 Abschluss-Element mod. TPA-7) • **FR** Plan de travail - Tiroir avec bac en plastique GN 1/1 15h (inclus 1 Élément de jonction top mod.TPA-7) • **ES** Sobre de trabajo Cajón con 1 contenedor GN 1/1 15h plástico (incluida 1 Chapa de cierre para top mod.TPA-7)
cm. 40x 70,5x 28h



876,00
26 / 0,18

PLT-76
18010600

PIANO LAVORO CASSETTO CON 1 BACINELLA: CM. 49X50X15H INOX (INCLUSA 1 TESTATA CHIUSURA PIANO MOD.TPA-7)

EN Worktop Drawer with 1 container: cm. 49x50x15h inox (included 1 Head end filler strip mod.TPA-7) • **DE** Arbeitsplatte Schublade mit 1 Behälter: cm. 49x50x15h inox (inbegriffen 1 Abschluss-Element mod. TPA-7) • **FR** Plan de travail Tiroir avec 1 bac: cm. 49x50x15h inox (inclus 1 Élément de jonction top mod.TPA-7) • **ES** Sobre de trabajo Cajón con 1 contenedore: cm. 49x50x15h inox (incluida 1 Chapa de cierre para top mod.TPA-7)
cm. 60x 70,5x 28h



1.093,00
36 / 0,26

PLT-78
18010800

PIANO LAVORO CASSETTO CON 2 BACINELLE GN 1/1 15H PLASTICA (INCLUSA 1 TESTATA CHIUSURA PIANO MOD. TPA-7)

EN Worktop - Drawer with 2 plastic containers GN 1/1 15h (included 1 Head end filler strip mod.TPA-7) • **DE** Arbeitsplatte - Schublade mit 2 GN 1/1 15h Kunststoffbehältern (inbegriffen 1 Abschluss-Element mod. TPA-7) • **FR** Plan de travail - Tiroir avec 2 bacs en plastique GN 1/1 15h (inclus 1 Élément de jonction top mod.TPA-7) • **ES** Sobre de trabajo Cajón con 2 contenedores GN 1/1 15h plástico (incluida 1 Chapa de cierre para top mod.TPA-7)
cm. 80x 70,5x 28h



1.233,00
43 / 0,35

LAT-74
18020400

LAVELLO RUBINETTO A LEVA - VASCA CM. 30X35X15H (INCLUSA 1 TESTATA CHIUSURA PIANO MOD.TPA-7)

EN Sink unit - Lever type tap - Bowl cm. 30x35x15h (included 1 Head end filler strip mod.TPA-7) • **DE** Spülbecken - Einhebel-Mischbatterie Becken cm. 30x35x15h (inbegriffen 1 Abschluss-Element mod.TPA-7) • **FR** Bac-évier avec robinetterie - Bac cm 30x35x15h (inclus 1 Élément de jonction top mod.TPA-7) • **ES** Fregadero - Grifo a palanca - Pileta cm. 30x35x15h (incluida 1 Chapa de cierre para top mod.TPA-7)
cm. 40x 70,5x 28h



1.072,00
22 / 0,18

PCT-74ET
18030430

PIANO COTTURA TRIFASE - N. 2 PIASTRE (INCLUSA 1 TESTATA CHIUSURA PIANO MOD.TPA-7)

EN Boiling unit threephase - N. 2 plates (included 1 Head end filler strip mod.TPA-7) • **DE** Kochplatte dreiphasig - N. 2 Kochplatten (inbegriffen 1 Abschluss-Element mod.TPA-7) • **FR** Rechaud électriques - N. 2 plaques (inclus 1 Élément de jonction top mod.TPA-7) • **ES** Sobre de cocción trifásico - N. 2 planchas (incluida 1 Chapa de cierre para top mod.TPA-7)
cm. 40x 70,5x 28h



⚡ 5,2 kW
400V~2N
230V~3
230V~
50/60 Hz

920,00
26 / 0,18

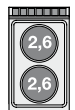

PCT-78ET
18030830

PIANO COTTURA TRIFASE N. 4 PIASTRE (INCLUSA 1 TESTATA CHIUSURA PIANO MOD.TPA-7)

EN Boiling unit threephase - N. 4 plates (included 1 Head end filler strip mod.TPA-7) • **DE** Kochplatte dreiphasig - N. 4 Kochplatten (inbegriffen 1 Abschluss-Element mod.TPA-7) • **FR** Rechaud électriques - N. 4 plaques (inclus 1 Élément de jonction top mod.TPA-7) • **ES** Sobre de cocción trifásico - N. 4 planchas (incluida 1 Chapa de cierre para top mod.TPA-7)
cm. 80x 70,5x 28h



⚡ 10,4 kW
400V~3N
230V~3
50/60 Hz

1.457,00
63 / 0,35

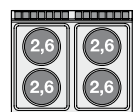

PIANI COTTURA ELETTRICI - TOP

MOD. _____
COD. _____

DESCRIZIONE/DESCRIPTION/BEZEICHNUNG/DESCRIPTION/DESCRIPCIÓN
DIMENSIONI/DIMENSIONS/ABMESSUNGEN/DIMENSIONS/DIMENSIONES

POTENZA/POWER/LEISTUNG/PUISSANCE/POTENCIA
VOLTAGGIO/VOLTAGE/SPANNUNG/VOLTAGE/VOLTAJE

⚡ kW _____
kcal/h _____
V~ _____
Hz _____

PREZZO/PRICE
PREIS/PRIX/PRECIO
KG / M³



PCT-712ET
18031230

PIANO COTTURA TRIFASE N. 6 PIASTRE (INCLUSA 1 TESTATA CHIUSURA PIANO MOD.TPA-7)

EN Boiling unit threephase - N. 6 plates (included 1 Head end filler strip mod.TPA-7) • **DE** Kochplatte dreiphasig - N. 6 Kochplatten (inbegriffen 1 Abschluss-Element mod.TPA-7) • **FR** Rechaud électriques - N. 6 plaques (inclus 1 Élément de jonction top mod.TPA-7) • **ES** Sobre de cocción trifásico - N. 6 planchas (incluida 1 Chapa de cierre para top mod.TPA-7)
cm. 120x 70,5x 28h



⚡ 15,6 kW _____ **2.328,00**
400V~3N _____ 82 / 0,51
230V~3
50/60 Hz

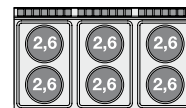

PCQT-74ET
18030431

PIANO COTTURA TRIFASE - N. 2 PIASTRE QUADRE (INCLUSA 1 TESTATA CHIUSURA PIANO MOD.TPA-7)

EN Boiling unit threephase - N. 2 square plates (included 1 Head end filler strip mod.TPA-7) • **DE** Kochplatte dreiphasig - N. 2 quadratischen Platten (inbegriffen 1 Abschluss-Element mod.TPA-7) • **FR** Rechaud électriques - N. 2 plaques carrés (inclus 1 Élément de jonction top mod.TPA-7) • **ES** Sobre de cocción trifásico - N. 2 planchas cuadradas (incluida 1 Chapa de cierre para top mod.TPA-7)
cm. 40x 70,5x 28h



⚡ 5,2 kW _____ **1.585,00**
400V~2N _____ 30 / 0,18
230V~3
230V~
50/60 Hz



PCQT-78ET
18030831

PIANO COTTURA TRIFASE - N. 4 PIASTRE QUADRE (INCLUSA 1 TESTATA CHIUSURA PIANO MOD.TPA-7)

EN Boiling unit threephase - N. 4 square plates (included 1 Head end filler strip mod.TPA-7) • **DE** Kochplatte dreiphasig - N. 4 quadratischen Platten (inbegriffen 1 Abschluss-Element mod.TPA-7) • **FR** Rechaud électriques - N. 4 plaques carrés (inclus 1 Élément de jonction top mod.TPA-7) • **ES** Sobre de cocción trifásico - N. 4 planchas cuadradas (incluida 1 Chapa de cierre para top mod.TPA-7)
cm. 80x 70,5x 28h



⚡ 10,4 kW _____ **2.705,00**
400V~3N _____ 66 / 0,35
230V~3
50/60 Hz

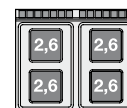

PCQT-712ET **PIANO COTTURA TRIFASE - N. 6 PIASTRE QUADRE (INCLUSA 1 TESTATA CHIUSURA PIANO MOD.TPA-7)**

18031231

EN Boiling unit threephase - N. 6 square plates (included 1 Head end filler strip mod.TPA-7) • **DE** Kochplatte dreiphasig - N. 6 quadratischen Platten (inbegriffen 1 Abschluss-Element mod.TPA-7) • **FR** Rechaud électriques - N. 6 plaques carrés (inclus 1 Élément de jonction top mod.TPA-7) • **ES** Sobre de cocción trifásico - N. 6 planchas cuadradas (incluida 1 Chapa de cierre para top mod.TPA-7)
cm. 120x 70,5x 28h



⚡ 15,6 kW _____ **4.195,00**
400V~3N _____ 97 / 0,51
230V~3
50/60 Hz



PCCT-74ET
18030432

PIANO COTTURA VETROCERAMICA TRIFASE - N. 2 ZONE VETRO CM.35X57 (INCLUSA 1 TESTATA CHIUSURA PIANO MOD.TPA-7)

EN Ceramic glass boiling unit - n. 2 zones - glass cm.35x57 (included 1 Head end filler strip mod.TPA-7) • **DE** Ceran-Kochplatte dreiphasig - 2 zonen - Glas 35x57 cm (inbegriffen 1 Abschluss-Element mod.TPA-7) • **FR** Plan de cuisson à vitroceramique triphasé N. 2 zones - Verre cm.35x57 (inclus 1 Élément de jonction top mod.TPA-7) • **ES** Sobre de cocción trifásico vitrocerámica - 2 zonas - vidrio cm.35x57 (incluida 1 Chapa de cierre para top mod.TPA-7)
cm. 40x 70,5x 28h

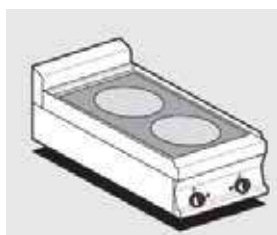

⚡ 5 kW _____ **1.935,00**
400V~2N _____ 35 / 0,18
230V~3
230V~
50/60 Hz

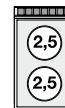

PCCT-78ET
18030832

PIANO COTTURA VETROCERAMICA TRIFASE - N. 4 ZONE VETRO CM.75X57 (INCLUSA 1 TESTATA CHIUSURA PIANO MOD.TPA-7)

EN Ceramic glass boiling unit - n. 4 zones - glass cm.75x57 (included 1 Head end filler strip mod.TPA-7) • **DE** Ceran-Kochplatte dreiphasig - 4 zonen - Glas 75x57 cm (inbegriffen 1 Abschluss-Element mod.TPA-7) • **FR** Plan de cuisson à vitroceramique triphasé N. 4 zones - Verre cm.75x57 (inclus 1 Élément de jonction top mod.TPA-7) • **ES** Sobre de cocción trifásico vitrocerámica - 4 zonas - vidrio cm.75x57 (incluida 1 Chapa de cierre para top mod.TPA-7)
cm. 80x 70,5x 28h



⚡ 10 kW _____ **2.935,00**
400V~3N _____ 62 / 0,35
230V~3
50/60 Hz

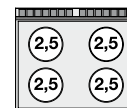

PIANI COTTURA A INDUZIONE - TOP

MOD. _____
COD. _____

DESCRIZIONE/DESCRIPTION/BEZEICHNUNG/DESCRIPTION/DESCRIPCIÓN
DIMENSIONI/DIMENSIONS/ABMESSUNGEN/DIMENSIONS/DIMENSIONES

POTENZA/POWER/LEISTUNG/PUISSANCE/POTENCIA
VOLTAGGIO/VOLTAGE/SPANNUNG/VOLTAGE/VOLTAJE

⚡ kW
kcal/h

⚡ kw
V~
Hz

PREZZO/PRICE
PREIS/PRIX/PRECIO
KG / M³



PCIT-74ET
18030433

PIANO COTTURA INDUZIONE TRIFASE - N. 2 ZONE - VETRO CM.35X57 (NON POSIZIONARE SU FORNI O CASSETTIERE) (INCLUSA 1 TESTATA CHIUSURA PIANO MOD.TPA-7)

EN Three-phase induction cooking - 2 zones - glass cm.35x57 (do not place on ovens or drawers) (included 1 Head end filler strip mod.TPA-7)
• **DE** Induktions-Kochplatte dreiphasig - 2 zonen - Glas 35x57 cm (nicht Platz auf Öfen oder Schubladen) (inbegriffen 1 Abschluss-Element mod. TPA-7) • **FR** Plan de cuisson à induction triphasé N. 2 zones - Verre cm.35x57 (ne placez pas sur des fours ou des tiroirs) (inclus 1 Élément de jonction top mod.TPA-7) • **ES** Encimera inducción trifásica - 2 zonas - Vidrio cm.35x57 (No coloque en los hornos o en los cajones) (incluida 1 Chapa de cierre para top mod.TPA-7)
cm. 40x 70,5x 28h



⚡ 10 kW
400V~3
50/60 Hz

7.849,00
34 / 0,18

PCIWT-74ET
18030434

PIANO COTTURA INDUZIONE TRIFASE "WOK" - N. 1 ZONA - VETRO Ø 30 CM. (NON POSIZIONARE SU FORNI O CASSETTIERE) (INCLUSA 1 TESTATA CHIUSURA PIANO MOD. TPA-7)

EN Three-phase induction cooking "WOK" - 1 zone - glass Ø 30 cm (do not place on ovens or drawers) (included 1 Head end filler strip mod. TPA-7) • **DE** Induktions-Kochplatte "WOK" dreiphasig - 1 zonen - Glas Ø 30 cm (nicht Platz auf Öfen oder Schubladen) (inbegriffen 1 Abschluss-Element mod.TPA-7) • **FR** Plan de cuisson à induction "WOK" triphasé N. 1 zone - Verre cm Ø 30 (ne placez pas sur des fours ou des tiroirs) (inclus 1 Élément de jonction top mod.TPA-7) • **ES** Encimera inducción "WOK" trifásica - 1 zona - Vidrio Ø 30 cm (No coloque en los hornos o en los cajones) (incluida 1 Chapa de cierre para top mod.TPA-7)
cm. 40x 70,5x 28h



⚡ 5 kW
400V~3
50/60 Hz

5.904,00
32 / 0,18

PCIT-78ET
18030833

PIANO COTTURA INDUZIONE TRIFASE - N. 4 ZONE - VETRO CM.75X57 (NON POSIZIONARE SU FORNI O CASSETTIERE) (INCLUSA 1 TESTATA CHIUSURA PIANO MOD.TPA-7)

EN Three-phase induction cooking - 4 zones - glass cm.75x57 (do not place on ovens or drawers) (included 1 Head end filler strip mod.TPA-7)
• **DE** Induktions-Kochplatte dreiphasig - 4 zonen - Glas 75x57 cm (nicht Platz auf Öfen oder Schubladen) (inbegriffen 1 Abschluss-Element mod. TPA-7) • **FR** Plan de cuisson à induction triphasé N. 4 zones - Verre cm.75x57 (ne placez pas sur des fours ou des tiroirs) (inclus 1 Élément de jonction top mod.TPA-7) • **ES** Encimera inducción trifásica - 4 zonas - Vidrio cm.75x57 (No coloque en los hornos o en los cajones) (incluida 1 Chapa de cierre para top mod.TPA-7)
cm. 80x 70,5x 28h



⚡ 20 kW
400V~3
50/60 Hz

14.702,00
66 / 0,35

PIANI COTTURA A INDUZIONE - TOP

MOD. _____
COD. _____

DESCRIZIONE/DESCRIPTION/BEZEICHNUNG/DESCRIPTION/DESCRIPCIÓN
DIMENSIONI/DIMENSIONS/ABMESSUNGEN/DIMENSIONS/DIMENSIONES

POTENZA/POWER/LEISTUNG/PUISSANCE/POTENCIA
VOLTAGGIO/VOLTAGE/SPANNUNG/VOLTAGE/VOLTAJE

⚡ kW
kcal/h

⚡ kW
V~
Hz

PREZZO/PRICE
PREIS/PRIX/PRECIO
KG / M³



PCT-74GP
18210450

PIANO COTTURA GAS 2 FUOCHI (INCLUSA 1 TESTATA CHIUSURA PIANO MOD.TPA-7)

EN Gas heated boiling unit - 2 burners (included 1 Head end filler strip mod.TPA-7) • **DE** Gas-kochplatte - 2 Kochstellen (inbegriffen 1 Abschluss-Element mod.TPA-7) • **FR** Rechaud gaz - 2 feux vifs (inclus 1 Élément de jonction top mod.TPA-7) • **ES** Sobres de cocción gas - 2 quemadores (incluida 1 Chapa de cierre para top mod.TPA-7)
cm. 40x 70,5x 28h



⚡ 13 kW
11.180 kcal/h

1.463,00
60 / 0,18

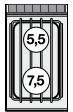

PCT-78GP
18210850

PIANO COTTURA GAS 4 FUOCHI (INCLUSA 1 TESTATA CHIUSURA PIANO MOD.TPA-7)

EN Gas heated boiling unit - 4 burners (included 1 Head end filler strip mod.TPA-7) • **DE** Gas-Kochplatte - 4 Kochstellen (inbegriffen 1 Abschluss-Element mod.TPA-7) • **FR** Rechaud gaz - 4 feux vifs (inclus 1 Élément de jonction top mod.TPA-7) • **ES** Sobres de cocción gas - 4 quemadores (incluida 1 Chapa de cierre para top mod.TPA-7)
cm. 80x 70,5x 28h



⚡ 22 kW
18.920 kcal/h

2.529,00
73 / 0,35

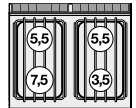

PCT-712GP
18211250

PIANO COTTURA GAS 6 FUOCHI (INCLUSA 1 TESTATA CHIUSURA PIANO MOD.TPA-7)

EN Gas heated boiling unit - 6 burners (included 1 Head end filler strip mod.TPA-7) • **DE** Gas-kochplatte - 6 Kochstellen (inbegriffen 1 Abschluss-Element mod.TPA-7) • **FR** Rechaud gaz - 6 feux vifs (inclus 1 Élément de jonction top mod.TPA-7) • **ES** Sobres de cocción gas - 6 quemadores (incluida 1 Chapa de cierre para top mod.TPA-7)
cm. 120x 70,5x 28h



⚡ 35 kW
30.100 kcal/h

3.633,00
119 / 0,51

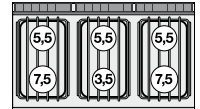

PC1T-74G
18210453

PIANO COTTURA GAS 1 FUOCO (INCLUSA 1 TESTATA CHIUSURA PIANO MOD.TPA-7)

EN Gas heated boiling unit - 1 burner (included 1 Head end filler strip mod.TPA-7) • **DE** Gas-kochplatte - 1 Kochstellen (inbegriffen 1 Abschluss-Element mod.TPA-7) • **FR** Rechaud gaz - 1 feux vifs (inclus 1 Élément de jonction top mod.TPA-7) • **ES** Sobres de cocción gas - 1 quemador (incluida 1 Chapa de cierre para top mod.TPA-7)
cm. 40x 70,5x 28h



⚡ 10 kW
8.600 kcal/h

1.699,00
60 / 0,18



PC2T-78G
18210853

PIANO COTTURA GAS 2 FUOCHI (INCLUSA 1 TESTATA CHIUSURA PIANO MOD.TPA-7)

EN Gas heated boiling unit - 2 burners (included 1 Head end filler strip mod.TPA-7) • **DE** Gas-kochplatte - 2 Kochstellen (inbegriffen 1 Abschluss-Element mod.TPA-7) • **FR** Rechaud gaz - 2 feux vifs (inclus 1 Élément de jonction top mod.TPA-7) • **ES** Sobres de cocción gas - 2 quemadores (incluida 1 Chapa de cierre para top mod.TPA-7)
cm. 80x 70,5x 28h



⚡ 17 kW
14.620 kcal/h

2.591,00
73 / 0,35

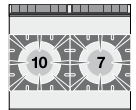

PIANI COTTURA A GAS - TOP

MOD. _____
COD. _____

DESCRIZIONE/DESCRIPTION/BEZEICHNUNG/DESCRIPTION/DESCRIPCIÓN
DIMENSIONI/DIMENSIONS/ABMESSUNGEN/DIMENSIONS/DIMENSIONES

POTENZA/POWER/LEISTUNG/PUISSANCE/POTENCIA
VOLTAGGIO/VOLTAGE/SPANNUNG/VOLTAGE/VOLTAJE

⚡ kW
kcal/h

⚡ kw
V~
Hz

PREZZO/PRICE
PREIS/PRIX/PRECIO
KG / M³



PC3T-712G
18211253

PIANO COTTURA GAS 3 FUOCHI (INCLUSA 1 TESTATA CHIUSURA PIANO MOD.TPA-7)
EN Gas heated boiling unit - 3 burners (included 1 Head end filler strip mod.TPA-7) • **DE** Gas-kochplatte - 3 Kochstellen (inbegriffen 1 Abschluss-Element mod.TPA-7) • **FR** Rechaud gaz - 3 feux vifs (inclus 1 Élément de jonction top mod.TPA-7) • **ES** Sobres de cocción gas - 3 quemadores (incluida 1 Chapa de cierre para top mod.TPA-7)
cm. 120x 70,5x 28h



⚡ 27 kW
23.220 kcal/h

3.730,00
119 / 0,51

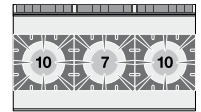

PAT-78G
18210851

"PAELLERO" GAS (INCLUSA 1 TESTATA CHIUSURA PIANO MOD.TPA-7)
EN "PAELLERO" Gas (included 1 Head end filler strip mod.TPA-7) • **DE** "PAELLERO" Gas (inbegriffen 1 Abschluss-Element mod.TPA-7) • **FR** "PAELLERO" gaz (inclus 1 Élément de jonction top mod.TPA-7) • **ES** "PAELLERO" gas (incluida 1 Chapa de cierre para top mod.TPA-7)
cm. 80x 70,5x 28h



⚡ 11,5 kW
9.890 kcal/h

3.091,00
127 / 0,35

TPT-74G
18290450

TUTTA PIASTRA PIASTRA CM 37X57 (INCLUSA 1 TESTATA CHIUSURA PIANO MOD.TPA-7)
EN Solid top - Plate 37x57cm (included 1 Head end filler strip mod.TPA-7) • **DE** Kochplatte - Platte 37x57 cm (inbegriffen 1 Abschluss-Element mod.TPA-7) • **FR** Toute plaque - Plaque cm 37x57 (inclus 1 Élément de jonction top mod.TPA-7) • **ES** Placa de cocción - Placa cm 37x57 (incluida 1 Chapa de cierre para top mod.TPA-7)
cm. 40x 70,5x 28h



⚡ 7 kW
6.020 kcal/h

1.938,00
60 / 0,18

TPT-78G
18290850

TUTTA PIASTRA PIASTRA CM 77X57 (INCLUSA 1 TESTATA CHIUSURA PIANO MOD.TPA-7)
EN Solid top - Plate 77x57cm (included 1 Head end filler strip mod.TPA-7) • **DE** Kochplatte - Platte 77x57 cm (inbegriffen 1 Abschluss-Element mod.TPA-7) • **FR** Toute plaque - Plaque cm. 77x57 (inclus 1 Élément de jonction top mod.TPA-7) • **ES** Placa de cocción - Placa cm 77x57 (incluida 1 Chapa de cierre para top mod.TPA-7)
cm. 80x 70,5x 28h



⚡ 12 kW
10.320 kcal/h

2.671,00
149 / 0,35

TPT-78ET
18120830

TUTTA PIASTRA PIASTRA CM. 70X50 - 4 ZONE (INCLUSA 1 TESTATA CHIUSURA PIANO MOD.TPA-7)
EN Solid top - Plate cm. 70x50- 4 zones (included 1 Head end filler strip mod.TPA-7) • **DE** Kochplatten - Platte cm. 70x50 - 4 zonen (inbegriffen 1 Abschluss-Element mod.TPA-7) • **FR** Toute plaque - Plaque cm. 70x50 - 4 zones (inclus 1 Élément de jonction top mod.TPA-7) • **ES** Placa de cocción - Placa cm. 70x50 - 4 zonas (incluida 1 Chapa de cierre para top mod.TPA-7)
cm. 80x 70,5x 28h



⚡ 10 kW
400V~3N
50/60 Hz

3.309,00
116 / 0,35

TP2T-78GP
18300850

TUTTA PIASTRA + 2 FUOCHI - PIASTRA CM 37X57 (INCLUSA 1 TESTATA CHIUSURA PIANO MOD.TPA-7)
EN Solid top + 2 burners - Plate 37x57 (included 1 Head end filler strip mod.TPA-7) • **DE** Kochplatte + 2 Gaskochstellen - Platte 37x57 (inbegriffen 1 Abschluss-Element mod.TPA-7) • **FR** Toute plaque + 2 brûleurs - Plaque cm 37x57 (inclus 1 Élément de jonction top mod.TPA-7) • **ES** Placa de cocción + 2 fuegos - Placa cm 37x57 (incluida 1 Chapa de cierre para top mod.TPA-7)
cm. 80x 70,5x 28h

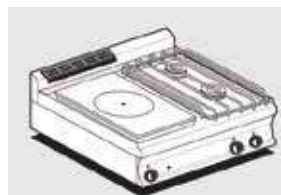

⚡ 20 kW
17.200 kcal/h

3.089,00
158 / 0,35

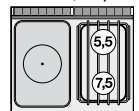

TP2T-712GP
18291250

TUTTA PIASTRA + 2 FUOCHI PIASTRA CM. 77X57 (INCLUSA 1 TESTATA CHIUSURA PIANO MOD.TPA-7)
EN Solid top + 2 burners - Plate 77x57 (included 1 Head end filler strip mod.TPA-7) • **DE** Kochplatte + 2 Gaskochstellen - Platte 77x57 (inbegriffen 1 Abschluss-Element mod.TPA-7) • **FR** Toute plaque + 2 brûleurs - Plaque cm. 77x57 (inclus 1 Élément de jonction top mod.TPA-7) • **ES** Placa de cocción + 2 fuegos - Placa cm. 77x57 (incluida 1 Chapa de cierre para top mod.TPA-7)
cm. 120x 70,5x 28h



⚡ 25 kW
21.500 kcal/h

3.901,00
175 / 0,51

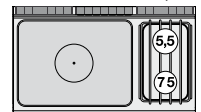

TUTTAPIASTRA A GAS - TOP

MOD. _____
COD. _____

DESCRIZIONE/DESCRIPTION/BEZEICHNUNG/DESCRIPTION/DESCRIPCIÓN
DIMENSIONI/DIMENSIONS/ABMESSUNGEN/DIMENSIONS/DIMENSIONES

POTENZA/POWER/LEISTUNG/PUISSANCE/POTENCIA
VOLTAGGIO/VOLTAGE/SPANNUNG/VOLTAGE/VOLTAJE

⚡ kW _____
kcal/h _____
V~ _____
Hz _____

PREZZO/PRICE
PREIS/PRIX/PRECIO
KG / M³



TP4T-712GP TUTTA PIASTRA + 4 FUOCHI PIASTRA CM. 37X57 (INCLUSA 1 TESTATA CHIUSURA PIANO MOD.TPA-7)

18301250

EN Solid top + 4 burners - Plate 37x57 (included 1 Head end filler strip mod.TPA-7) • **DE** Kochplatte + 4 Gaskochstellen - Platte 37x57 (inbegriffen 1 Abschluss-Element mod.TPA-7) • **FR** Toute plaque + 4 brûleurs - Plaque cm. 37x57 (inclus 1 Élément de jonction top mod.TPA-7) • **ES** Placa de cocción + 4 fuegos - Placa cm. 37x57 (incluida 1 Chapa de cierre para top mod.TPA-7)
cm. 120x 70,5x 28h



⚡ 29 kW _____ **4.226,00**
24.940 kcal/h _____ 202 / 0,51

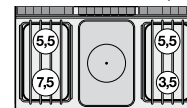

BMT-74EM BAGNOMARIA MONOFASE VASCA PER GN 1/1 H.15 (INCLUSA 1 TESTATA CHIUSURA PIANO MOD.TPA-7)

18050410

EN Bain marie singlephase - Bowl for GN 1/1 h.15 (included 1 Head end filler strip mod.TPA-7) • **DE** Wasserbäder einphasig - Becken GN 1/1 h.15 (inbegriffen 1 Abschluss-Element mod.TPA-7) • **FR** Bain marie monophasé - Cuve GN 1/1 h.15 (inclus 1 Élément de jonction top mod.TPA-7) • **ES** Baño de maría monofásico - Cuba para GN 1/1 15h (incluida 1 Chapa de cierre para top mod.TPA-7)
cm. 40x 70,5x 28h



⚡ 2,1 kW _____ **1.336,00**
230V~ _____ 35 / 0,18
50/60 Hz

BMT-78ET BAGNOMARIA TRIFASE VASCA PER GN 2/1 15H (INCLUSA 1 TESTATA CHIUSURA PIANO MOD.TPA-7)

18050830

EN Bain marie threephase - Bowl for GN 2/1 15h (included 1 Head end filler strip mod.TPA-7) • **DE** Wasserbäder dreiphasig - Becken GN 2/1 15h (inbegriffen 1 Abschluss-Element mod.TPA-7) • **FR** Bain marie triphase - Cuve GN 2/1 15h (inclus 1 Élément de jonction top mod.TPA-7) • **ES** Baño de maría trifásico - Cuba para GN 2/1 15h (incluida 1 Chapa de cierre para top mod.TPA-7)
cm. 80x 70,5x 28h



⚡ 4,2 kW _____ **1.810,00**
400V~2N _____ 54 / 0,35
230V~3 _____
50/60 Hz

BMT-74G BAGNOMARIA GAS VASCA PER GN 1/1 H.15 (INCLUSA 1 TESTATA CHIUSURA PIANO MOD.TPA-7)

18220450

EN Gas bain-marie - Bowl for GN 1/1 h.15 (included 1 Head end filler strip mod.TPA-7) • **DE** Gas Wasserbad - Becken GN 1/1 h.15 (inbegriffen 1 Abschluss-Element mod.TPA-7) • **FR** Bain-marie gaz - Cuve pour GN 1/1 h.15 (inclus 1 Élément de jonction top mod.TPA-7) • **ES** Baño de maría gas - Cuba para GN 1/1 15h (incluida 1 Chapa de cierre para top mod.TPA-7)
cm. 40x 70,5x 28h



⚡ 3,5 kW _____ **1.696,00**
3.010 kcal/h _____ 43 / 0,18

BMT-78G BAGNOMARIA GAS VASCA PER GN 2/1 H.15 (INCLUSA 1 TESTATA CHIUSURA PIANO MOD.TPA-7)

18220850

EN Gas bain-marie - Bowl for GN 2/1 h.15 (included 1 Head end filler strip mod.TPA-7) • **DE** Gas Wasserbad - Becken GN 2/1 h.15 (inbegriffen 1 Abschluss-Element mod.TPA-7) • **FR** Bain-marie gaz - Cuve pour GN 2/1 h.15 (inclus 1 Élément de jonction top mod.TPA-7) • **ES** Baño de maría gas - Cuba para GN 2/1 15h (incluida 1 Chapa de cierre para top mod.TPA-7)
cm. 80x 70,5x 28h



⚡ 6,5 kW _____ **2.326,00**
5.590 kcal/h _____ 61 / 0,35

BST-74EM CONTENITORE CALDO CON INFRAROSSO MONOFASE VASCA CM. 30,5X51X16,5H CON FALSO FONDO FORATO (INCLUSA 1 TESTATA CHIUSURA PIANO MOD.TPA-7)

18040410

EN Fry dump singlephase with infra-red heater. Bowl cm. 30,5x51x16,5h with perforated double bottom (included 1 Head end filler strip mod.TPA-7) • **DE** Frittenwanne Einphasig mit Infrarot-strahler. Becke cm. 30,5x51x16,5h mit gelochtem Bodenrost (inbegriffen 1 Abschluss-Element mod.TPA-7) • **FR** Silo a frites monophasé avec infrarouge. Cuve cm 30,5x51x16,5h avec double-fond perforé. (inclus 1 Élément de jonction top mod.TPA-7) • **ES** Contenedor caliente por infrarrojo monofásico. Cuba cm. 30,5x51x16,5h con falso fondo agujereado (incluida 1 Chapa de cierre para top mod.TPA-7)
cm. 40x 70,5x 28h



⚡ 1,47 kW _____ **1.639,00**
230V~ _____ 36 / 0,21
50/60 Hz

CUOCIPASTA ELETTRICI - TOP

MOD. _____
COD. _____

DESCRIZIONE/DESCRIPTION/BEZEICHNUNG/DESCRIPTION/DESCRIPCIÓN
DIMENSIONI/DIMENSIONS/ABMESSUNGEN/DIMENSIONS/DIMENSIONES

POTENZA/POWER/LEISTUNG/PUISSANCE/POTENCIA
VOLTAGGIO/VOLTAGE/SPANNUNG/VOLTAGE/VOLTAJE

⚡ kcal/h ⚡ kw
V~ Hz

PREZZO/PRICE
PREIS/PRIX/PRECIO
KG / M³



CPT-74ET
18100430

**CUOCIPASTA TRIFASE LT. 17 VASCA CM. 31X33,5X22H.
RUBINETTO SCARICO (CESTI ESCLUSI) (INCLUSA 1 TESTATA
CHIUSURA PIANO MOD.TPA-7)**

EN Pasta cooker threephase 17 lts. Tank cm. 31x33,5x22h. Drain-top (BASKETS EXCLUDED) (included 1 Head end filler strip mod.TPA-7) • **DE** Nudelkocher dreiphasig lt.17 Becken cm. 31x33,5x22h. Ablasshahn (KORB AUSGESCHLOSSEN) (inbegriffen 1 Abschluss-Element mod.TPA-7) • **FR** Cuiseur à pates triphase lt.17 Cuve cm. 31x33,5x22h. Robinet de vidange (PANIERS EXCLUS) (inclus 1 Élément de jonction top mod.TPA-7) • **ES** Cuece pasta trifásico lt.17 Cuba cm. 31x33,5x22h. Grifo descarga (CESTAS EXCLUIDAS) (incluida 1 Chapa de cierre para top mod.TPA-7)
cm. 40x 70,5x 28h



⚡ 4,1 kW **1.896,00**
400V~3N 35 / 0,18
230V~
50/60 Hz

COMBINAZIONI

- Combinations / • Zusammenstellungen
- Combinaisons / • Combinación múltiple



CPT-76ET
18100630

**CUOCIPASTA TRIFASE LT. 25 VASCA CM. 51X31X22H.
RUBINETTO SCARICO (CESTI ESCLUSI) (INCLUSA 1 TESTATA
CHIUSURA PIANO MOD.TPA-7)**

EN Pasta cooker threephase 25 lts. Tank cm. 51x31x22h. Drain-top (BASKETS EXCLUDED) (included 1 Head end filler strip mod.TPA-7) • **DE** Nudelkocher dreiphasig lt.25 Becken cm. 51x31x22h. Ablasshahn (KORB AUSGESCHLOSSEN) (inbegriffen 1 Abschluss-Element mod.TPA-7) • **FR** Cuiseur à pates triphase lt.25 Cuve cm. 51x31x22h. Robinet de vidange (PANIERS EXCLUS) (inclus 1 Élément de jonction top mod.TPA-7) • **ES** Cuece pasta trifásico lt.25 Cuba cm. 51x31x22h. Grifo descarga (CESTAS EXCLUIDAS) (incluida 1 Chapa de cierre para top mod.TPA-7)
cm. 60x 70,5x 28h



⚡ 6,25 kW **2.166,00**
400V~3N 45 / 0,26
50/60 Hz

COMBINAZIONI

- Combinations / • Zusammenstellungen
- Combinaisons / • Combinación múltiple



CPT-74G
18270450

**CUOCIPASTA A GAS CAPACITA' LT. 13 VASCA CM.
31X33,5X18H. RUBINETTO SCARICO (CESTI ESCLUSI)
(INCLUSA 1 TESTATA CHIUSURA PIANO MOD.TPA-7)**

EN Gas pasta cookers Tank capacity 13 lts. Tank cm. 31x33,5x18h. Drain-top (BASKETS EXCLUDED) (included 1 Head end filler strip mod.TPA-7) • **DE** Gas -Nudelkocher Beckeninhalt lt.13 Becken cm. 31x33,5x18h. Ablasshahn (KORB AUSGESCHLOSSEN) (inbegriffen 1 Abschluss-Element mod.TPA-7) • **FR** Cuiseur à pates gaz Cuve lt.13 Cuve cm. 31x33,5x18h. Robinet de vidange (PANIERS EXCLUS) (inclus 1 Élément de jonction top mod.TPA-7) • **ES** Cuece pasta gas Cuba 13 lt. Cuba cm. 31x33,5x18h. Grifo descarga (CESTAS EXCLUIDAS) (incluida 1 Chapa de cierre para top mod.TPA-7)
cm. 40x 70,5x 28h



⚡ 6 kW **2.058,00**
5.160 kcal/h 38 / 0,18

COMBINAZIONI

- Combinations / • Zusammenstellungen
- Combinaisons / • Combinación múltiple



CUOCIPASTA A GAS - TOP

MOD. _____
COD. _____

DESCRIZIONE/DESCRIPTION/BEZEICHNUNG/DESCRIPTION/DESCRIPCIÓN
DIMENSIONI/DIMENSIONS/ABMESSUNGEN/DIMENSIONS/DIMENSIONES

POTENZA/POWER/LEISTUNG/PUISSANCE/POTENCIA
VOLTAGGIO/VOLTAGE/SPANNUNG/VOLTAGE/VOLTAJE

⚡ $\frac{\text{kW}}{\text{kcal/h}}$ $\frac{\text{kW}}{\text{V-}}$
Hz

PREZZO/PRICE
PREIS/PRIX/PRECIO
KG / M³



CPT-76G
18270650

CUOCIPASTA A GAS CAPACITA' LT. 19 VASCA CM. 51X31X18H. RUBINETTO SCARICO (CESTI ESCLUSI) (INCLUSA 1 TESTATA CHIUSURA PIANO MOD.TPA-7)

EN Gas pasta cookers Tank capacity 19 lts. Tank cm. 51x31x18h. Drain-tap (BASKETS EXCLUDED) (included 1 Head end filler strip mod.TPA-7)
• **DE** Gas -Nudelkocher Beckeninhalt lt. 19 Becken cm. 51x31x18h. Ablasshahn (KORB AUSGESCHLOSSEN) (inbegriffen 1 Abschluss-Element mod.TPA-7) • **FR** Cuiseur à pâtes gaz Cuve lt.19 Cuve cm. 51x31x18h. Robinet de vidange (PANIERS EXCLUS) (inclus 1 Élément de jonction top mod.TPA-7) • **ES** Cucece pasta gas Cuba 19 lt. Cuba cm. 51x31x18h. Grifo descarga (CESTAS EXCLUIDAS) (incluida 1 Chapa de cierre para top mod.TPA-7)
cm. 60x 70,5x 28h



⚡ $\frac{9 \text{ kW}}{7.740 \text{ kcal/h}}$ **2.431,00**
49 / 0,26

COMBINAZIONI

- Combinations / • Zusammenstellungen
- Combinaisons / • Combinación múltiple



FTLT-74ET
18060431

FRY-TOP ELETTRICO LISCIO, PIASTRA CM.36X51 (INCLUSA 1 TESTATA CHIUSURA PIANO MOD.TPA-7)

EN Electric Fry-top smooth griddle, plate cm.36x51 (included 1 Head end filler strip mod.TPA-7) • **DE** Griddleplatte elektrische glatt, platte cm.36x51 (inbegriffen 1 Abschluss-Element mod.TPA-7) • **FR** Plaque électriques lisse, plaque cm.36x51 (inclus 1 Élément de jonction top mod.TPA-7) • **ES** Fry-top eléctrico liso, plancha cm.36x51 (incluida 1 Chapa de cierre para top mod.TPA-7)
cm. 40x 70,5x 28h



⚡ $\frac{5,55 \text{ kW}}{400V\sim 3N}$ **1.841,00**
 $\frac{230V\sim 3}{50/60 \text{ Hz}}$ 58 / 0,18

FTLT-74ETS
18060434

FRY-TOP ELETTRICO LISCIO CROMATO SUPERCHROME (MOCA APPROVED), PIASTRA CM.36X51 (INCLUSA 1 TESTATA CHIUSURA PIANO MOD.TPA-7)

EN Electric Fry-top smooth chromed griddle SUPERCHROME (Moca Approved), plate cm.36x51 (included 1 Head end filler strip mod.TPA-7) • **DE** Griddleplatte elektrische glatt hartverchromt SUPERCHROME (Moca Approved), platte cm.36x51 (inbegriffen 1 Abschluss-Element mod.TPA-7) • **FR** Plaque électriques lisse chromée SUPERCHROME (Moca Approved), plaque cm.36x51 (inclus 1 Élément de jonction top mod.TPA-7) • **ES** Fry-top eléctrico liso cromado SUPERCHROME (Moca Approved), plancha cm.36x51 (incluida 1 Chapa de cierre para top mod.TPA-7)
cm. 40x 70,5x 28h

⚡ $\frac{5,55 \text{ kW}}{400V\sim 3N}$ **2.161,00**
 $\frac{230V\sim 3}{50/60 \text{ Hz}}$ 58 / 0,18

FTLT-74ETSS
18060430

FRY-TOP ELETTRICO LISCIO CROMO LUCIDO, PIASTRA CM.36X51 (INCLUSA 1 TESTATA CHIUSURA PIANO MOD.TPA-7)

EN Electric Fry-top smooth POLISHED CHROME, plate cm.36x51 (included 1 Head end filler strip mod.TPA-7) • **DE** Griddleplatte elektrische glatt POLIERTEM CHROM, platte cm.36x51 (inbegriffen 1 Abschluss-Element mod.TPA-7) • **FR** Plaque électriques lisse CHROME POLI, plaque cm.36x51 (inclus 1 Élément de jonction top mod.TPA-7) • **ES** Fry-top eléctrico liso CROMO PULIDO, plancha cm.36x51 (incluida 1 Chapa de cierre para top mod.TPA-7)
cm. 40x 70,5x 28h

⚡ $\frac{5,55 \text{ kW}}{400V\sim 3N}$ **2.161,00**
 $\frac{230V\sim 3}{50/60 \text{ Hz}}$ 58 / 0,18

FTRT-74ET
18060433

FRY-TOP ELETTRICO RIGATO, PIASTRA CM.36X51 (INCLUSA 1 TESTATA CHIUSURA PIANO MOD.TPA-7)

EN Electric Fry-top grooved griddle, plate cm.36x51 (included 1 Head end filler strip mod.TPA-7) • **DE** Griddleplatte elektrische gerillt, platte cm.36x51 (inbegriffen 1 Abschluss-Element mod.TPA-7) • **FR** Plaque électriques nervurée, plaque cm.36x51 (inclus 1 Élément de jonction top mod.TPA-7) • **ES** Fry-top eléctrico estriado, plancha cm.36x51 (incluida 1 Chapa de cierre para top mod.TPA-7)
cm. 40x 70,5x 28h



⚡ $\frac{5,55 \text{ kW}}{400V\sim 3N}$ **1.988,00**
 $\frac{230V\sim 3}{50/60 \text{ Hz}}$ 58 / 0,18

FRY-TOP ELETTRICI - TOP

MOD. _____
COD. _____

DESCRIZIONE/DESCRIPTION/BEZEICHNUNG/DESCRIPTION/DESCRIPCIÓN
DIMENSIONI/DIMENSIONS/ABMESSUNGEN/DIMENSIONS/DIMENSIONES

POTENZA/POWER/LEISTUNG/PUISSANCE/POTENCIA
VOLTAGGIO/VOLTAGE/SPANNUNG/VOLTAGE/VOLTAJE

⚡ kW kcal/h
⚡ kW V~ Hz

PREZZO/PRICE
PREIS/PRIX/PRECIO
KG / M³



FTRT-74ETS
18060436

FRY-TOP ELETTRICO RIGATO CROMATO SUPERCHROME (MOCA APPROVED), PIASTRA CM.36X51 (INCLUSA 1 TESTATA CHIUSURA PIANO MOD.TPA-7)

EN Electric Fry-top grooved chromed griddle SUPERCHROME (Moca Approved), plate cm.36x51 (included 1 Head end filler strip mod.TPA-7)
• **DE** Griddleplatte elektrische gerillt hartverchromt SUPERCHROME (Moca Approved), platte cm.36x51 (inbegriffen 1 Abschluss-Element mod.TPA-7)
• **FR** Plaque électriques nervurée chromée SUPERCHROME (Moca Approved), plaque cm.36x51 (inclus 1 Élément de jonction top mod.TPA-7)
• **ES** Fry-top eléctrico estriado cromado SUPERCHROME (Moca Approved), plancha cm.36x51 (incluida 1 Chapa de cierre para top mod.TPA-7)
cm. 40x 70,5x 28h



⚡ 5,55 kW 2.302,00
400V~3N 58 / 0,18
230V~3
50/60 Hz



FTLT-76ET
18060631

FRY-TOP ELETTRICO LISCIO, PIASTRA CM.56X51 (INCLUSA 1 TESTATA CHIUSURA PIANO MOD.TPA-7)

EN Electric Fry-top smooth griddle, plate cm.56x51 (included 1 Head end filler strip mod.TPA-7)
• **DE** Griddleplatte elektrische glatt, platte cm.56x51 (inbegriffen 1 Abschluss-Element mod.TPA-7)
• **FR** Plaque électriques lisse, plaque cm.56x51 (inclus 1 Élément de jonction top mod.TPA-7)
• **ES** Fry-top eléctrico liso, plancha cm.56x51 (incluida 1 Chapa de cierre para top mod.TPA-7)
cm. 60x 70,5x 28h



⚡ 7,4 kW 2.106,00
400V~3N 67 / 0,26
50/60 Hz

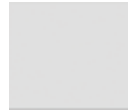

FTLT-76ETS
18060634

FRY-TOP ELETTRICO LISCIO CROMATO SUPERCHROME (MOCA APPROVED), PIASTRA CM.56X51 (INCLUSA 1 TESTATA CHIUSURA PIANO MOD.TPA-7)

EN Electric Fry-top smooth chromed griddle SUPERCHROME (Moca Approved), plate cm.56x51 (included 1 Head end filler strip mod.TPA-7)
• **DE** Griddleplatte elektrische glatt hartverchromt SUPERCHROME (Moca Approved), platte cm.56x51 (inbegriffen 1 Abschluss-Element mod.TPA-7)
• **FR** Plaque électriques lisse chromée SUPERCHROME (Moca Approved), plaque cm.56x51 (inclus 1 Élément de jonction top mod.TPA-7)
• **ES** Fry-top eléctrico liso cromado SUPERCHROME (Moca Approved), plancha cm.56x51 (incluida 1 Chapa de cierre para top mod.TPA-7)
cm. 60x 70,5x 28h

⚡ 7,4 kW 2.637,00
400V~3N 67 / 0,26
50/60 Hz

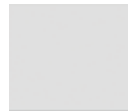

FTLT-76ETSS
18060630

FRY-TOP ELETTRICO LISCIO CROMO LUCIDO, PIASTRA CM.56X51 (INCLUSA 1 TESTATA CHIUSURA PIANO MOD.TPA-7)

EN Electric Fry-top smooth POLISHED CHROME, plate cm.56x51 (included 1 Head end filler strip mod.TPA-7)
• **DE** Griddleplatte elektrische glatt POLIERTEM CHROM, platte cm.56x51 (inbegriffen 1 Abschluss-Element mod.TPA-7)
• **FR** Plaque électriques lisse CHROME POLI, plaque cm.56x51 (inclus 1 Élément de jonction top mod.TPA-7)
• **ES** Fry-top eléctrico liso CROMO PULIDO, plancha cm.56x51 (incluida 1 Chapa de cierre para top mod.TPA-7)
cm. 60x 70,5x 28h

⚡ 7,4 kW 2.637,00
400V~3N 67 / 0,26
50/60 Hz

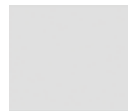

FTLRT-76ET
18060632

FRY-TOP ELETTRICO 1/2 RIGATO + 1/2 LISCIO, PIASTRA CM.56X51 (INCLUSA 1 TESTATA CHIUSURA PIANO MOD.TPA-7)

EN Electric Fry-top 1/2 grooved + 1/2 smooth, plate cm.56x51 (included 1 Head end filler strip mod.TPA-7)
• **DE** Griddleplatte elektrische 1/2 gerillt + 1/2 glatt, platte cm.56x51 (inbegriffen 1 Abschluss-Element mod.TPA-7)
• **FR** Plaque électriques 1/2 nervurée + 1/2 lisse, plaque cm.56x51 (inclus 1 Élément de jonction top mod.TPA-7)
• **ES** Fry-top eléctrico 1/2 estriado + 1/2 liso, plancha cm.56x51 (incluida 1 Chapa de cierre para top mod.TPA-7)
cm. 60x 70,5x 28h



⚡ 7,4 kW 2.271,00
400V~3N 67 / 0,26
50/60 Hz



FRY-TOP ELETTRICI - TOP

MOD. _____
COD. _____

DESCRIZIONE/DESCRIPTION/BEZEICHNUNG/DESCRIPTION/DESCRIPCIÓN
DIMENSIONI/DIMENSIONS/ABMESSUNGEN/DIMENSIONS/DIMENSIONES

POTENZA/POWER/LEISTUNG/PUISSANCE/POTENCIA
VOLTAGGIO/VOLTAGE/SPANNUNG/VOLTAGE/VOLTAJE

⚡ kW _____
kcal/h _____
V~ _____
Hz _____

PREZZO/PRICE
PREIS/PRIX/PRECIO
KG / M³



FTLRT-76ETS FRY-TOP ELETTRICO 1/2 RIGATO + 1/2 LISCIO CROMATO SUPERCHROME (MOCA APPROVED), PIASTRA CM.56X51 (INCLUSA 1 TESTATA CHIUSURA PIANO MOD.TPA-7)

18060635

EN Electric Fry-top 1/2 grooved + 1/2 smooth chromed griddle SUPERCHROME (Moca Approved), plate cm.56x51 (included 1 Head end filler strip mod.TPA-7) • **DE** Griddleplatte elektrische 1/2 gerillt + 1/2 glatt hartverchromt SUPERCHROME (Moca Approved), platte cm.56x51 (inbegriffen 1 Abschluss-Element mod.TPA-7) • **FR** Plaque électriques 1/2 nervurée + 1/2 lisse chromée SUPERCHROME (Moca Approved), plaque cm.56x51 (inclus 1 Élément de jonction top mod.TPA-7) • **ES** Fry-top eléctrico 1/2 estriado + 1/2 liso cromado SUPERCHROME (Moca Approved), plancha cm.56x51 (incluida 1 Chapa de cierre para top mod.TPA-7)

cm. 60x 70,5x 28h



⚡ 7,4 kW _____ **2.796,00**
400V~3N _____ 67 / 0,26
50/60 Hz _____



FTRT-76ET FRY-TOP ELETTRICO RIGATO, PIASTRA CM.56X51 (INCLUSA 1 TESTATA CHIUSURA PIANO MOD.TPA-7)

18060633

EN Electric Fry-top grooved griddle, plate cm.56x51 (included 1 Head end filler strip mod.TPA-7) • **DE** Griddleplatte elektrische gerillt, platte cm.56x51 (inbegriffen 1 Abschluss-Element mod.TPA-7) • **FR** Plaque électriques nervurée, plaque cm.56x51 (inclus 1 Élément de jonction top mod.TPA-7) • **ES** Fry-top eléctrico estriado, plancha cm.56x51 (incluida 1 Chapa de cierre para top mod.TPA-7)

cm. 60x 70,5x 28h



⚡ 7,4 kW _____ **2.434,00**
400V~3N _____ 67 / 0,26
50/60 Hz _____



FTRT-76ETS FRY-TOP ELETTRICO RIGATO CROMATO SUPERCHROME (MOCA APPROVED), PIASTRA CM.56X51 (INCLUSA 1 TESTATA CHIUSURA PIANO MOD.TPA-7)

18060636

EN Electric Fry-top grooved chromed griddle SUPERCHROME (Moca Approved), plate cm.56x51 (included 1 Head end filler strip mod.TPA-7) • **DE** Griddleplatte elektrische gerillt hartverchromt SUPERCHROME (Moca Approved), platte cm.56x51 (inbegriffen 1 Abschluss-Element mod.TPA-7) • **FR** Plaque électriques nervurée chromée SUPERCHROME (Moca Approved), plaque cm.56x51 (inclus 1 Élément de jonction top mod.TPA-7) • **ES** Fry-top eléctrico estriado cromado SUPERCHROME (Moca Approved), plancha cm.56x51 (incluida 1 Chapa de cierre para top mod.TPA-7)

cm. 60x 70,5x 28h

⚡ 7,4 kW _____ **2.963,00**
400V~3N _____ 67 / 0,26
50/60 Hz _____



FTLT-78ET FRY-TOP ELETTRICO LISCIO, PIASTRA CM.76X51 - 2 ZONE DI COTTURA (INCLUSA 1 TESTATA CHIUSURA PIANO MOD.TPA-7)

18060831

EN Electric Fry-top smooth griddle, plate cm.76x51 - 2 cooking areas (included 1 Head end filler strip mod.TPA-7) • **DE** Griddleplatte elektrische glatt, platte cm.76x51 - 2 Heizzonen (inbegriffen 1 Abschluss-Element mod.TPA-7) • **FR** Plaque électriques lisse, plaque cm.76x51 - 2 zones de cuisson (inclus 1 Élément de jonction top mod.TPA-7) • **ES** Fry-top eléctrico liso, plancha cm.76x51 - 2 zonas de cocción (incluida 1 Chapa de cierre para top mod.TPA-7)

cm. 80x 70,5x 28h



⚡ 11,1 kW _____ **2.736,00**
400V~3N _____ 103 / 0,35
230V~3 _____
50/60 Hz _____

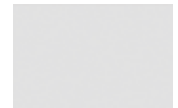

FTLT-78ETS FRY-TOP ELETTRICO LISCIO CROMATO SUPERCHROME (MOCA APPROVED), PIASTRA CM.76X51 - 2 ZONE DI COTTURA (INCLUSA 1 TESTATA CHIUSURA PIANO MOD.TPA-7)

18060834

EN Electric Fry-top smooth chromed griddle SUPERCHROME (Moca Approved), plate cm.76x51 - 2 cooking areas (included 1 Head end filler strip mod.TPA-7) • **DE** Griddleplatte elektrische glatt hartverchromt SUPERCHROME (Moca Approved), platte cm.76x51 - 2 Heizzonen (inbegriffen 1 Abschluss-Element mod.TPA-7) • **FR** Plaque électriques lisse chromée SUPERCHROME (Moca Approved), plaque cm.76x51 - 2 zones de cuisson (inclus 1 Élément de jonction top mod.TPA-7) • **ES** Fry-top eléctrico liso cromado SUPERCHROME (Moca Approved), plancha cm.76x51 - 2 zonas de cocción (incluida 1 Chapa de cierre para top mod.TPA-7)

cm. 80x 70,5x 28h

⚡ 11,1 kW _____ **3.413,00**
400V~3N _____ 103 / 0,35
230V~3 _____
50/60 Hz _____



FRY-TOP ELETTRICI - TOP

MOD. _____
COD. _____

DESCRIZIONE/DESCRIPTION/BEZEICHNUNG/DESCRIPTION/DESCRIPCIÓN
DIMENSIONI/DIMENSIONS/ABMESSUNGEN/DIMENSIONS/DIMENSIONES

POTENZA/POWER/LEISTUNG/PUISSANCE/POTENCIA
VOLTAGGIO/VOLTAGE/SPANNUNG/VOLTAGE/VOLTAJE

⚡ kW kcal/h
V~ Hz

PREZZO/PRICE
PREIS/PRIX/PRECIO
KG / M³



FTLT-78ETSS FRY-TOP ELETTRICO LISCIO CROMO LUCIDO, PIASTRA
18060830 **CM.76X51 - 2 ZONE DI COTTURA (INCLUSA 1 TESTATA
CHIUSURA PIANO MOD.TPA-7)**

EN Electric Fry-top smooth POLISHED CHROME, plate cm.76x51 - 2 cooking areas (included 1 Head end filler strip mod.TPA-7) • **DE** Griddleplatte elektrische glatt POLIERTEM CHROM, platte cm.76x51 - 2 Heizzonen (inbegriffen 1 Abschluss-Element mod.TPA-7) • **FR** Plaque électriques lisse CHROME POLI, plaque cm.76x51 - 2 zones de cuisson (inclus 1 Élément de jonction top mod.TPA-7) • **ES** Fry-top eléctrico liso CROMO PULIDO, plancha cm.76x51 - 2 zonas de cocción (incluida 1 Chapa de cierre para top mod.TPA-7)
cm. 80x 70,5x 28h



⚡ 11,1 kW **3.413,00**
400V~3N 103 / 0,35
230V~3
50/60 Hz

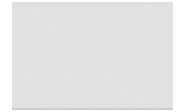

FTLRT-78ET FRY-TOP ELETTRICO 1/2 RIGATO + 1/2 LISCIO, PIASTRA
18060832 **CM.76X51 - 2 ZONE DI COTTURA (INCLUSA 1 TESTATA
CHIUSURA PIANO MOD.TPA-7)**

EN Electric Fry-top 1/2 grooved + 1/2 smooth, plate cm.76x51 - 2 cooking areas (included 1 Head end filler strip mod.TPA-7) • **DE** Griddleplatte elektrische 1/2 gerillt + 1/2 glatt, platte cm.76x51 - 2 Heizzonen (inbegriffen 1 Abschluss-Element mod.TPA-7) • **FR** Plaque électriques 1/2 nervurée + 1/2 lisse, plaque cm.76x51 - 2 zones de cuisson (inclus 1 Élément de jonction top mod.TPA-7) • **ES** Fry-top eléctrico 1/2 estriado + 1/2 liso, plancha cm.76x51 - 2 zonas de cocción (incluida 1 Chapa de cierre para top mod.TPA-7)
cm. 80x 70,5x 28h



⚡ 11,1 kW **2.952,00**
400V~3N 103 / 0,35
230V~3
50/60 Hz



FTLRT-78ETS FRY-TOP ELETTRICO 1/2 RIGATO + 1/2 LISCIO CROMATO
18060835 **SUPERCHROME (MOCA APPROVED), PIASTRA CM.76X51 - 2
ZONE DI COTTURA (INCLUSA 1 TESTATA CHIUSURA PIANO
MOD.TPA-7)**

EN Electric Fry-top 1/2 grooved + 1/2 smooth chromed griddle SUPERCHROME (Moca Approved), plate cm.76x51 - 2 cooking areas (included 1 Head end filler strip mod.TPA-7) • **DE** Griddleplatte elektrische 1/2 gerillt + 1/2 glatt hartverchromt SUPERCHROME (Moca Approved), platte cm.76x51 - 2 Heizzonen (inbegriffen 1 Abschluss-Element mod.TPA-7) • **FR** Plaque électriques 1/2 nervurée + 1/2 lisse chromée SUPERCHROME (Moca Approved), plaque cm.76x51 - 2 zones de cuisson (inclus 1 Élément de jonction top mod.TPA-7) • **ES** Fry-top eléctrico 1/2 estriado + 1/2 liso cromado SUPERCHROME (Moca Approved), plancha cm.76x51 - 2 zonas de cocción (incluida 1 Chapa de cierre para top mod.TPA-7)
cm. 80x 70,5x 28h

⚡ 11,1 kW **3.620,00**
400V~3N 103 / 0,35
230V~3
50/60 Hz



FTRT-78ET FRY-TOP ELETTRICO RIGATO, PIASTRA CM.76X51 - 2 ZONE
18060833 **DI COTTURA (INCLUSA 1 TESTATA CHIUSURA PIANO MOD.
TPA-7)**

EN Electric Fry-top grooved griddle, plate cm.76x51 - 2 cooking areas (included 1 Head end filler strip mod.TPA-7) • **DE** Griddleplatte elektrische gerillt, platte cm.76x51 - 2 Heizzonen (inbegriffen 1 Abschluss-Element mod.TPA-7) • **FR** Plaque électriques nervurée, plaque cm.76x51 - 2 zones de cuisson (inclus 1 Élément de jonction top mod.TPA-7) • **ES** Fry-top eléctrico estriado, plancha cm.76x51 - 2 zonas de cocción (incluida 1 Chapa de cierre para top mod.TPA-7)
cm. 80x 70,5x 28h



⚡ 11,1 kW **3.112,00**
400V~3N 103 / 0,35
230V~3
50/60 Hz



FTRT-78ETS FRY-TOP ELETTRICO RIGATO CROMATO SUPERCHROME
18060836 **(MOCA APPROVED), PIASTRA CM.76X51 - 2 ZONE DI
COTTURA (INCLUSA 1 TESTATA CHIUSURA PIANO MOD.
TPA-7)**

EN Electric Fry-top grooved chromed griddle SUPERCHROME (Moca Approved), plate cm.76x51 - 2 cooking areas (included 1 Head end filler strip mod.TPA-7) • **DE** Griddleplatte elektrische gerillt hartverchromt SUPERCHROME (Moca Approved), platte cm.76x51 - 2 Heizzonen (inbegriffen 1 Abschluss-Element mod.TPA-7) • **FR** Plaque électriques nervurée chromée SUPERCHROME (Moca Approved), plaque cm.76x51 - 2 zones de cuisson (inclus 1 Élément de jonction top mod.TPA-7) • **ES** Fry-top eléctrico estriado cromado SUPERCHROME (Moca Approved), plancha cm.76x51 - 2 zonas de cocción (incluida 1 Chapa de cierre para top mod.TPA-7)
cm. 80x 70,5x 28h

⚡ 11,1 kW **3.822,00**
400V~3N 103 / 0,35
230V~3
50/60 Hz



FRY-TOP ELETTRICI - TOP

MOD. _____
COD. _____

DESCRIZIONE/DESCRIPTION/BEZEICHNUNG/DESCRIPTION/DESCRIPCIÓN
DIMENSIONI/DIMENSIONS/ABMESSUNGEN/DIMENSIONS/DIMENSIONES

POTENZA/POWER/LEISTUNG/PUISSANCE/POTENCIA
VOLTAGGIO/VOLTAGE/SPANNUNG/VOLTAGE/VOLTAJE

⚡ kW kcal/h
⚡ kW V~ Hz

PREZZO/PRICE
PREIS/PRIX/PRECIO
KG / M³



FTLT-712ET **FRY-TOP ELETTRICO LISCIO, PIASTRA CM.116X51 - 2 ZONE DI COTTURA (INCLUSA 1 TESTATA CHIUSURA PIANO MOD. TPA-7)**
18061231

EN Electric Fry-top smooth griddle, plate cm.116x51 - 2 cooking areas (included 1 Head end filler strip mod.TPA-7) • **DE** Griddleplatte elektrische glatt, platte cm.116x51 - 2 Heizzonen (inbegriffen 1 Abschluss-Element mod.TPA-7) • **FR** Plaque électriques lisse, plaque cm.116x51 - 2 zones de cuisson (inclus 1 Élément de jonction top mod.TPA-7) • **ES** Fry-top eléctrico liso, plancha cm.116x51 - 2 zonas de cocción (incluida 1 Chapa de cierre para top mod.TPA-7)
cm. 120x 70,5x 28h



⚡ 14,8 kW **3.873,00**
400V~3N 114 / 0,51
50/60 Hz

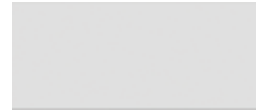

FTLT-712ETS **FRY-TOP ELETTRICO LISCIO CROMATO SUPERCHROME (MOCA APPROVED), PIASTRA CM.116X51 - 2 ZONE DI COTTURA (INCLUSA 1 TESTATA CHIUSURA PIANO MOD.TPA-7)**
18061234

EN Electric Fry-top smooth chromed griddle SUPERCHROME (Moca Approved), plate cm.116x51 - 2 cooking areas (included 1 Head end filler strip mod.TPA-7) • **DE** Griddleplatte elektrische glatt hartverchromt SUPERCHROME (Moca Approved), platte cm.116x51 - 2 Heizzonen (inbegriffen 1 Abschluss-Element mod.TPA-7) • **FR** Plaque électriques lisse chromée SUPERCHROME (Moca Approved), plaque cm.116x51 - 2 zones de cuisson (inclus 1 Élément de jonction top mod.TPA-7) • **ES** Fry-top eléctrico liso cromado SUPERCHROME (Moca Approved), plancha cm.116x51 - 2 zonas de cocción (incluida 1 Chapa de cierre para top mod.TPA-7)
cm. 120x 70,5x 28h

⚡ 14,8 kW **4.827,00**
400V~3N 114 / 0,51
50/60 Hz

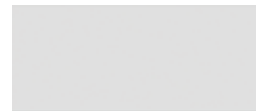

FTLRT-712ET **FRY-TOP ELETTRICO 1/2 RIGATO + 1/2 LISCIO, PIASTRA CM.116X51 - 2 ZONE DI COTTURA (INCLUSA 1 TESTATA CHIUSURA PIANO MOD.TPA-7)**
18061232

EN Electric Fry-top 1/2 grooved + 1/2 smooth, plate cm.116x51 - 2 cooking areas (included 1 Head end filler strip mod.TPA-7) • **DE** Griddleplatte elektrische 1/2 gerillt + 1/2 glatt, platte cm.116x51 - 2 Heizzonen (inbegriffen 1 Abschluss-Element mod.TPA-7) • **FR** Plaque électriques 1/2 nervurée + 1/2 lisse, plaque cm.116x51 - 2 zones de cuisson (inclus 1 Élément de jonction top mod.TPA-7) • **ES** Fry-top eléctrico 1/2 estriado + 1/2 liso, plancha cm.116x51 - 2 zonas de cocción (incluida 1 Chapa de cierre para top mod.TPA-7)
cm. 120x 70,5x 28h

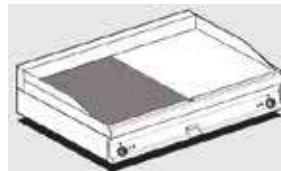

⚡ 14,8 kW **4.065,00**
400V~3N 114 / 0,51
50/60 Hz



FTLRT-712ETS **FRY-TOP ELETTRICO 1/2 RIGATO + 1/2 LISCIO CROMATO SUPERCHROME (MOCA APPROVED), PIASTRA CM.116X51 - 2 ZONE DI COTTURA (INCLUSA 1 TESTATA CHIUSURA PIANO MOD.TPA-7)**
18061235

EN Electric Fry-top 1/2 grooved + 1/2 smooth chromed griddle SUPERCHROME (Moca Approved), plate cm.116x51 - 2 cooking areas (included 1 Head end filler strip mod.TPA-7) • **DE** Griddleplatte elektrische 1/2 gerillt + 1/2 glatt hartverchromt SUPERCHROME (Moca Approved), platte cm.116x51 - 2 Heizzonen (inbegriffen 1 Abschluss-Element mod.TPA-7) • **FR** Plaque électriques 1/2 nervurée + 1/2 lisse chromée SUPERCHROME (Moca Approved), plaque cm.116x51 - 2 zones de cuisson (inclus 1 Élément de jonction top mod.TPA-7) • **ES** Fry-top eléctrico 1/2 estriado + 1/2 liso cromado SUPERCHROME (Moca Approved), plancha cm.116x51 - 2 zonas de cocción (incluida 1 Chapa de cierre para top mod.TPA-7)
cm. 120x 70,5x 28h

⚡ 14,8 kW **5.119,00**
400V~3N 114 / 0,51
50/60 Hz



FTRT-712ET **FRY-TOP ELETTRICO RIGATO, PIASTRA CM.116X51 - 2 ZONE DI COTTURA (INCLUSA 1 TESTATA CHIUSURA PIANO MOD. TPA-7)**
18061233

EN Electric Fry-top grooved griddle, plate cm.116x51 - 2 cooking areas (included 1 Head end filler strip mod.TPA-7) • **DE** Griddleplatte elektrische gerillt, platte cm.116x51 - 2 Heizzonen (inbegriffen 1 Abschluss-Element mod.TPA-7) • **FR** Plaque électriques nervurée, plaque cm.116x51 - 2 zones de cuisson (inclus 1 Élément de jonction top mod.TPA-7) • **ES** Fry-top eléctrico estriado, plancha cm.116x51 - 2 zonas de cocción (incluida 1 Chapa de cierre para top mod.TPA-7)
cm. 120x 70,5x 28h



⚡ 14,8 kW **4.269,00**
400V~3N 114 / 0,51
50/60 Hz



FRY-TOP ELETTRICI - TOP

MOD. _____
COD. _____

DESCRIZIONE/DESCRIPTION/BEZEICHNUNG/DESCRIPTION/DESCRIPCIÓN
DIMENSIONI/DIMENSIONS/ABMESSUNGEN/DIMENSIONS/DIMENSIONES

POTENZA/POWER/LEISTUNG/PUISSANCE/POTENCIA
VOLTAGGIO/VOLTAGE/SPANNUNG/VOLTAGE/VOLTAJE

⚡ kW kcal/h
⚡ kW V~ Hz

PREZZO/PRICE
PREIS/PRIX/PRECIO
KG / M³



FTRT-712ETS FRY-TOP ELETTRICO RIGATO CROMATO SUPERCHROME (MOCA APPROVED), PIASTRA CM.116X51 - 2 ZONE DI COTTURA (INCLUSA 1 TESTATA CHIUSURA PIANO MOD. TPA-7)

18061236

EN Electric Fry-top grooved chromed griddle SUPERCHROME (Moca Approved), plate cm.116x51 - 2 cooking areas (included 1 Head end filler strip mod.TPA-7) • **DE** Griddleplatte elektrische gerillt hartverchromt SUPERCHROME (Moca Approved), platte cm.116x51 - 2 Heizzonen (inbegriffen 1 Abschluss-Element mod.TPA-7) • **FR** Plaque électriques nervurée chromée SUPERCHROME (Moca Approved), plaque cm.116x51 - 2 zones de cuisson (inclus 1 Élément de jonction top mod.TPA-7) • **ES** Fry-top eléctrico estriado cromado SUPERCHROME (Moca Approved), plancha cm.116x51 - 2 zonas de cocción (incluida 1 Chapa de cierre para top mod.TPA-7)
cm. 120x 70,5x 28h



⚡ 14,8 kW
400V~3N
50/60 Hz

5.495,00
114 / 0,51



FTLT-712ET3 FRY-TOP ELETTRICO LISCIO, PIASTRA CM.116X51 - 3 ZONE DI COTTURA (INCLUSA 1 TESTATA CHIUSURA PIANO MOD. TPA-7)

1806123B

EN Electric Fry-top smooth griddle, plate cm.116x51 - 3 cooking areas (included 1 Head end filler strip mod.TPA-7) • **DE** Griddleplatte elektrische glatt, platte cm.116x51 - 3 Heizzonen (inbegriffen 1 Abschluss-Element mod.TPA-7) • **FR** Plaque électriques lisse, plaque cm.116x51 - 3 zones de cuisson (inclus 1 Élément de jonction top mod.TPA-7) • **ES** Fry-top eléctrico liso, plancha cm.116x51 - 3 zonas de cocción (incluida 1 Chapa de cierre para top mod.TPA-7)
cm. 120x 70,5x 28h



⚡ 16,65 kW
400V~3N
50/60 Hz

4.393,00
114 / 0,51

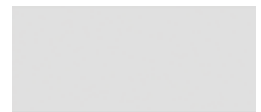

FTLT-712ETS3 FRY-TOP ELETTRICO LISCIO CROMATO SUPERCHROME (MOCA APPROVED), PIASTRA CM.116X51 - 3 ZONE DI COTTURA (INCLUSA 1 TESTATA CHIUSURA PIANO MOD.TPA-7)

1806123E

EN Electric Fry-top smooth chromed griddle SUPERCHROME (Moca Approved), plate cm.116x51 - 3 cooking areas (included 1 Head end filler strip mod.TPA-7) • **DE** Griddleplatte elektrische glatt hartverchromt SUPERCHROME (Moca Approved), platte cm.116x51 - 3 Heizzonen (inbegriffen 1 Abschluss-Element mod.TPA-7) • **FR** Plaque électriques lisse chromée SUPERCHROME (Moca Approved), plaque cm.116x51 - 3 zones de cuisson (inclus 1 Élément de jonction top mod.TPA-7) • **ES** Fry-top eléctrico liso cromado SUPERCHROME (Moca Approved), plancha cm.116x51 - 3 zonas de cocción (incluida 1 Chapa de cierre para top mod.TPA-7)
cm. 120x 70,5x 28h

⚡ 16,65 kW
400V~3N
50/60 Hz

5.199,00
114 / 0,51

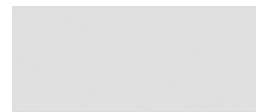

FTLT-712ETSS3 FRY-TOP ELETTRICO LISCIO CROMO LUCIDO, PIASTRA CM.116X51 - 3 ZONE DI COTTURA (INCLUSA 1 TESTATA CHIUSURA PIANO MOD.TPA-7)

1806123Y

EN Electric Fry-top smooth POLISHED CHROME, plate cm.116x51 - 3 cooking areas (included 1 Head end filler strip mod.TPA-7) • **DE** Griddleplatte elektrische glatt POLIERTEM CHROM, platte cm.116x51 - 3 Heizzonen (inbegriffen 1 Abschluss-Element mod.TPA-7) • **FR** Plaque électriques lisse CHROME POLI, plaque cm.116x51 - 3 zones de cuisson (inclus 1 Élément de jonction top mod.TPA-7) • **ES** Fry-top eléctrico liso CROMO PULIDO, plancha cm.116x51 - 3 zonas de cocción (incluida 1 Chapa de cierre para top mod.TPA-7)
cm. 120x 70,5x 28h

⚡ 16,65 kW
400V~3N
50/60 Hz

5.199,00
114 / 0,51

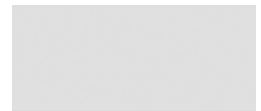

FTLRT-712ET3 FRY-TOP ELETTRICO 1/3 RIGATO + 2/3 LISCIO, PIASTRA CM.116X51 - 3 ZONE DI COTTURA (INCLUSA 1 TESTATA CHIUSURA PIANO MOD.TPA-7)

1806123C

EN Electric Fry-top 1/3 grooved + 2/3 smooth, plate cm.116x51 - 3 cooking areas (included 1 Head end filler strip mod.TPA-7) • **DE** Griddleplatte elektrische 1/3 gerillt + 2/3 glatt, platte cm.116x51 - 3 Heizzonen (inbegriffen 1 Abschluss-Element mod.TPA-7) • **FR** Plaque électriques 1/3 nervurée + 2/3 lisse, plaque cm.116x51 - 3 zones de cuisson (inclus 1 Élément de jonction top mod.TPA-7) • **ES** Fry-top eléctrico 1/3 estriado + 2/3 liso, plancha cm.116x51 - 3 zonas de cocción (incluida 1 Chapa de cierre para top mod.TPA-7)
cm. 120x 70,5x 28h



⚡ 16,65 KW
400V~3N
50/60 Hz

4.514,00
114 / 0,51



FRY-TOP ELETTRICI - TOP

MOD. _____
COD. _____

DESCRIZIONE/DESCRIPTION/BEZEICHNUNG/DESCRIPTION/DESCRIPCIÓN
DIMENSIONI/DIMENSIONS/ABMESSUNGEN/DIMENSIONS/DIMENSIONES

POTENZA/POWER/LEISTUNG/PUISSANCE/POTENCIA
VOLTAGGIO/VOLTAGE/SPANNUNG/VOLTAGE/VOLTAJE

⚡ kW _____
kcal/h _____
V~ _____
Hz _____

PREZZO/PRICE
PREIS/PRIX/PRECIO
KG / M³



FTLRT-712ETS3 FRY-TOP ELETTRICO 1/3 RIGATO + 2/3 LISCIO CROMATO SUPERCHROME (MOCA APPROVED), PIASTRA CM.116X51 - 3 ZONE DI COTTURA (INCLUSA 1 TESTATA CHIUSURA PIANO MOD.TPA-7)

1806123F

EN Electric Fry-top 1/3 grooved + 2/3 smooth chromed griddle SUPERCHROME (Moca Approved), plate cm.116x51 - 3 cooking areas (included 1 Head end filler strip mod.TPA-7) • **DE** Griddleplatte elektrische 1/3 gerillt + 2/3 glatt hartverchromt SUPERCHROME (Moca Approved), platte cm.116x51 - 3 Heizzonen (inbegriffen 1 Abschluss-Element mod.TPA-7) • **FR** Plaque électriques 1/3 nervurée + 2/3 lisse chromée SUPERCHROME (Moca Approved), plaque cm.116x51 - 3 zones de cuisson (inclus 1 Élément de jonction top mod.TPA-7) • **ES** Fry-top eléctrico 1/3 estriado + 2/3 liso cromado SUPERCHROME (Moca Approved), plancha cm.116x51 - 3 zonas de cocción (incluida 1 Chapa de cierre para top mod.TPA-7)
cm. 120x 70,5x 28h



⚡ 16,65 kW
400V~3N
50/60 Hz

5.391,00
114 / 0,51



FTLT-74G FRY-TOP GAS LISCIO, PIASTRA CM.36X51 (INCLUSA 1 TESTATA CHIUSURA PIANO MOD.TPA-7)

18230451

EN Gas Fry-top smooth griddle, plate cm.36x51 (included 1 Head end filler strip mod.TPA-7) • **DE** Gas-griddleplatte glatt, platte cm.36x51 (inbegriffen 1 Abschluss-Element mod.TPA-7) • **FR** Plaque gaz lisse, plaque cm.36x51 (inclus 1 Élément de jonction top mod.TPA-7) • **ES** Fry-top gas liso, plancha cm.36x51 (incluida 1 Chapa de cierre para top mod.TPA-7)
cm. 40x 70,5x 28h



⚡ 7 kW
6.020 kcal/h

1.811,00
63 / 0,18



FTLT-74GS FRY-TOP GAS LISCIO CROMATO SUPERCHROME (MOCA APPROVED), PIASTRA CM.36X51 (INCLUSA 1 TESTATA CHIUSURA PIANO MOD.TPA-7)

18230454

EN Gas Fry-top smooth chromed griddle SUPERCHROME (Moca Approved), plate cm.36x51 (included 1 Head end filler strip mod.TPA-7) • **DE** Gas-griddleplatte glatt hartverchromt SUPERCHROME (Moca Approved), platte cm.36x51 (inbegriffen 1 Abschluss-Element mod.TPA-7) • **FR** Plaque gaz lisse chromée SUPERCHROME (Moca Approved), plaque cm.36x51 (inclus 1 Élément de jonction top mod.TPA-7) • **ES** Fry-top gas liso cromado SUPERCHROME (Moca Approved), plancha cm.36x51 (incluida 1 Chapa de cierre para top mod.TPA-7)
cm. 40x 70,5x 28h

⚡ 7 kW
6.020 kcal/h

2.254,00
63 / 0,18



FTLT-74GSS FRY-TOP GAS LISCIO CROMO LUCIDO, PIASTRA CM.36X51 (INCLUSA 1 TESTATA CHIUSURA PIANO MOD.TPA-7)

18230450

EN Gas Fry-top smooth POLISHED CHROME, plate cm.36x51 (included 1 Head end filler strip mod.TPA-7) • **DE** Gas-griddleplatte glatt POLIERTEM CHROM, platte cm.36x51 (inbegriffen 1 Abschluss-Element mod.TPA-7) • **FR** Plaque gaz lisse CHROME POLI, plaque cm.36x51 (inclus 1 Élément de jonction top mod.TPA-7) • **ES** Fry-top gas liso CROMO PULIDO, plancha cm.36x51 (incluida 1 Chapa de cierre para top mod.TPA-7)
cm. 40x 70,5x 28h

⚡ 7 kW
6.020 kcal/h

2.254,00
63 / 0,18



FTRT-74G FRY-TOP GAS RIGATO, PIASTRA CM.36X51 (INCLUSA 1 TESTATA CHIUSURA PIANO MOD.TPA-7)

18230453

EN Gas Fry-top grooved griddle, plate cm.36x51 (included 1 Head end filler strip mod.TPA-7) • **DE** Gas-griddleplatte gerillt, platte cm.36x51 (inbegriffen 1 Abschluss-Element mod.TPA-7) • **FR** Plaque gaz nervurée, plaque cm.36x51 (inclus 1 Élément de jonction top mod.TPA-7) • **ES** Fry-top gas estriado, plancha cm.36x51 (incluida 1 Chapa de cierre para top mod.TPA-7)
cm. 40x 70,5x 28h

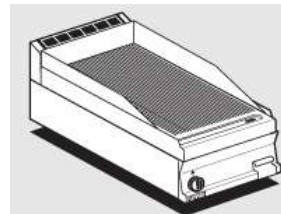

⚡ 7 kW
6.020 kcal/h

2.010,00
63 / 0,18

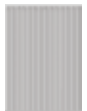

FTRT-74GS FRY-TOP GAS RIGATO CROMATO SUPERCHROME (MOCA APPROVED), PIASTRA CM.36X51 (INCLUSA 1 TESTATA CHIUSURA PIANO MOD.TPA-7)

18230456

EN Gas Fry-top grooved chromed griddle SUPERCHROME (Moca Approved), plate cm.36x51 (included 1 Head end filler strip mod.TPA-7) • **DE** Gas-griddleplatte gerillt hartverchromt SUPERCHROME (Moca Approved), platte cm.36x51 (inbegriffen 1 Abschluss-Element mod.TPA-7) • **FR** Plaque gaz nervurée chromée SUPERCHROME (Moca Approved), plaque cm.36x51 (inclus 1 Élément de jonction top mod.TPA-7) • **ES** Fry-top gas estriado cromado SUPERCHROME (Moca Approved), plancha cm.36x51 (incluida 1 Chapa de cierre para top mod.TPA-7)
cm. 40x 70,5x 28h

⚡ 7 kW
6.020 kcal/h

2.456,00
63 / 0,18



FRY-TOP A GAS - TOP

MOD. _____
COD. _____

DESCRIZIONE/DESCRIPTION/BEZEICHNUNG/DESCRIPTION/DESCRIPCIÓN
DIMENSIONI/DIMENSIONS/ABMESSUNGEN/DIMENSIONS/DIMENSIONES

POTENZA/POWER/LEISTUNG/PUISSANCE/POTENCIA
VOLTAGGIO/VOLTAGE/SPANNUNG/VOLTAGE/VOLTAJE

10,5 kW
9.030 kcal/h

10,5 kW
9.030 kcal/h

PREZZO/PRICE
PREIS/PRIX/PRECIO
KG / M³



FTLT-76G
18230651

FRY-TOP GAS LISCIO, PIASTRA CM.56X51 (INCLUSA 1 TESTATA CHIUSURA PIANO MOD.TPA-7)

EN Gas Fry-top smooth griddle, plate cm.56x51 (included 1 Head end filler strip mod.TPA-7) • **DE** Gas-griddleplatte glatt, platte cm.56x51 (inbegriffen 1 Abschluss-Element mod.TPA-7) • **FR** Plaque gaz lisse, plaque cm.56x51 (inclus 1 Élément de jonction top mod.TPA-7) • **ES** Fry-top gas liso, plancha cm.56x51 (incluida 1 Chapa de cierre para top mod.TPA-7)

cm. 60x 70,5x 28h



10,5 kW
9.030 kcal/h

2.220,00
68 / 0,26

FTLT-76GS
18230654

FRY-TOP GAS LISCIO CROMATO SUPERCHROME (MOCA APPROVED), PIASTRA CM.56X51 (INCLUSA 1 TESTATA CHIUSURA PIANO MOD.TPA-7)

EN Gas Fry-top smooth chromed griddle SUPERCHROME (Moca Approved), plate cm.56x51 (included 1 Head end filler strip mod.TPA-7) • **DE** Gas-griddleplatte glatt hartverchromt SUPERCHROME (Moca Approved), platte cm.56x51 (inbegriffen 1 Abschluss-Element mod.TPA-7) • **FR** Plaque gaz lisse chromée SUPERCHROME (Moca Approved), plaque cm.56x51 (inclus 1 Élément de jonction top mod.TPA-7) • **ES** Fry-top gas liso cromado SUPERCHROME (Moca Approved), plancha cm.56x51 (incluida 1 Chapa de cierre para top mod.TPA-7)

cm. 60x 70,5x 28h

10,5 kW
9.030 kcal/h

2.766,00
68 / 0,26

FTLT-76GS
18230650

FRY-TOP GAS LISCIO CROMO LUCIDO, PIASTRA CM.56X51 (INCLUSA 1 TESTATA CHIUSURA PIANO MOD.TPA-7)

EN Gas Fry-top smooth POLISHED CHROME, plate cm.56x51 (included 1 Head end filler strip mod.TPA-7) • **DE** Gas-griddleplatte glatt POLIERTEM CHROM, platte cm.56x51 (inbegriffen 1 Abschluss-Element mod.TPA-7) • **FR** Plaque gaz lisse CHROME POLI, plaque cm.56x51 (inclus 1 Élément de jonction top mod.TPA-7) • **ES** Fry-top gas liso CROMO PULIDO, plancha cm.56x51 (incluida 1 Chapa de cierre para top mod.TPA-7)

cm. 60x 70,5x 28h

10,5 kW
9.030 kcal/h

2.766,00
68 / 0,26

FTLRT-76G
18230652

FRY-TOP GAS 1/2 RIGATO + 1/2 LISCIO, PIASTRA CM.56X51 (INCLUSA 1 TESTATA CHIUSURA PIANO MOD.TPA-7)

EN Gas Fry-top 1/2 grooved + 1/2 smooth, plate cm.56x51 (included 1 Head end filler strip mod.TPA-7) • **DE** Gas-griddleplatte 1/2 gerillt + 1/2 glatt, platte cm.56x51 (inbegriffen 1 Abschluss-Element mod.TPA-7) • **FR** Plaque gaz 1/2 nervurée + 1/2 lisse, plaque cm.56x51 (inclus 1 Élément de jonction top mod.TPA-7) • **ES** Fry-top gas 1/2 estriado + 1/2 liso, plancha cm.56x51 (incluida 1 Chapa de cierre para top mod.TPA-7)

cm. 60x 70,5x 28h



10,5 kW
9.030 kcal/h

2.378,00
68 / 0,26

FTLRT-76GS
18230655

FRY-TOP GAS 1/2 RIGATO + 1/2 LISCIO CROMATO SUPERCHROME (MOCA APPROVED), PIASTRA CM.56X51 (INCLUSA 1 TESTATA CHIUSURA PIANO MOD.TPA-7)

EN Gas Fry-top 1/2 grooved + 1/2 smooth chromed griddle SUPERCHROME (Moca Approved), plate cm.56x51 (included 1 Head end filler strip mod.TPA-7) • **DE** Gas-griddleplatte 1/2 gerillt + 1/2 glatt hartverchromt SUPERCHROME (Moca Approved), platte cm.56x51 (inbegriffen 1 Abschluss-Element mod.TPA-7) • **FR** Plaque gaz 1/2 nervurée + 1/2 lisse chromée SUPERCHROME (Moca Approved), plaque cm.56x51 (inclus 1 Élément de jonction top mod.TPA-7) • **ES** Fry-top gas 1/2 estriado + 1/2 liso cromado SUPERCHROME (Moca Approved), plancha cm.56x51 (incluida 1 Chapa de cierre para top mod.TPA-7)

cm. 60x 70,5x 28h

10,5 kW
9.030 kcal/h

2.927,00
68 / 0,26

FRY-TOP A GAS - TOP

MOD. _____
COD. _____

DESCRIZIONE/DESCRIPTION/BEZEICHNUNG/DESCRIPTION/DESCRIPCIÓN
DIMENSIONI/DIMENSIONS/ABMESSUNGEN/DIMENSIONS/DIMENSIONES

POTENZA/POWER/LEISTUNG/PUISSANCE/POTENCIA
VOLTAGGIO/VOLTAGE/SPANNUNG/VOLTAGE/VOLTAJE

⚡ 10,5 kW
9.030 kcal/h

PREZZO/PRICE
PREIS/PRIX/PRECIO
KG / M³



FTRT-76G
18230653

FRY-TOP GAS RIGATO, PIASTRA CM.56X51 (INCLUSA 1 TESTATA CHIUSURA PIANO MOD.TPA-7)

EN Gas Fry-top grooved griddle, plate cm.56x51 (included 1 Head end filler strip mod.TPA-7) • **DE** Gas-griddleplatte gerillt, platte cm.56x51 (inbegriffen 1 Abschluss-Element mod.TPA-7) • **FR** Plaque gaz nervurée, plaque cm.56x51 (inclus 1 Élément de jonction top mod.TPA-7) • **ES** Fry-top gas estriado, plancha cm.56x51 (incluida 1 Chapa de cierre para top mod.TPA-7)
cm. 60x 70,5x 28h

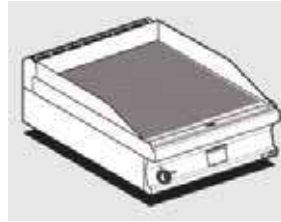

⚡ 10,5 kW
9.030 kcal/h

2.537,00
68 / 0,26



FTRT-76GS
18230656

FRY-TOP GAS RIGATO CROMATO SUPERCHROME (MOCA APPROVED), PIASTRA CM.56X51 (INCLUSA 1 TESTATA CHIUSURA PIANO MOD.TPA-7)

EN Gas Fry-top grooved chromed griddle SUPERCHROME (Moca Approved), plate cm.56x51 (included 1 Head end filler strip mod.TPA-7) • **DE** Gas-griddleplatte gerillt hartverchromt SUPERCHROME (Moca Approved), platte cm.56x51 (inbegriffen 1 Abschluss-Element mod.TPA-7) • **FR** Plaque gaz nervurée chromée SUPERCHROME (Moca Approved), plaque cm.56x51 (inclus 1 Élément de jonction top mod.TPA-7) • **ES** Fry-top gas estriado cromado SUPERCHROME (Moca Approved), plancha cm.56x51 (incluida 1 Chapa de cierre para top mod.TPA-7)
cm. 60x 70,5x 28h

⚡ 10,5 kW
9.030 kcal/h

3.086,00
68 / 0,26



FTLT-78G
18230851

FRY-TOP GAS LISCIO, PIASTRA CM.76X51 - 2 ZONE DI COTTURA (INCLUSA 1 TESTATA CHIUSURA PIANO MOD.TPA-7)

EN Gas Fry-top smooth griddle, plate cm.76x51 - 2 cooking areas (included 1 Head end filler strip mod.TPA-7) • **DE** Gas-griddleplatte glatt, platte cm.76x51 - 2 Heizzonen (inbegriffen 1 Abschluss-Element mod.TPA-7) • **FR** Plaque gaz lisse, plaque cm.76x51 - 2 zones de cuisson (inclus 1 Élément de jonction top mod.TPA-7) • **ES** Fry-top gas liso, plancha cm.76x51 - 2 zonas de cocción (incluida 1 Chapa de cierre para top mod.TPA-7)
cm. 80x 70,5x 28h



⚡ 14 kW
12.040 kcal/h

3.272,00
108 / 0,35

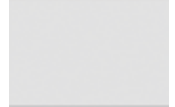

FTLT-78GS
18230854

FRY-TOP GAS LISCIO CROMATO SUPERCHROME (MOCA APPROVED), PIASTRA CM.76X51 - 2 ZONE DI COTTURA (INCLUSA 1 TESTATA CHIUSURA PIANO MOD.TPA-7)

EN Gas Fry-top smooth chromed griddle SUPERCHROME (Moca Approved), plate cm.76x51 - 2 cooking areas (included 1 Head end filler strip mod.TPA-7) • **DE** Gas-griddleplatte glatt hartverchromt SUPERCHROME (Moca Approved), platte cm.76x51 - 2 Heizzonen (inbegriffen 1 Abschluss-Element mod.TPA-7) • **FR** Plaque gaz lisse chromée SUPERCHROME (Moca Approved), plaque cm.76x51 - 2 zones de cuisson (inclus 1 Élément de jonction top mod.TPA-7) • **ES** Fry-top gas liso cromado SUPERCHROME (Moca Approved), plancha cm.76x51 - 2 zonas de cocción (incluida 1 Chapa de cierre para top mod.TPA-7)
cm. 80x 70,5x 28h

⚡ 14 kW
12.040 kcal/h

4.076,00
108 / 0,35

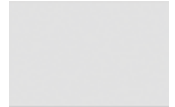

FTLT-78GSS
18230850

FRY-TOP GAS LISCIO CROMO LUCIDO, PIASTRA CM.76X51 - 2 ZONE DI COTTURA (INCLUSA 1 TESTATA CHIUSURA PIANO MOD.TPA-7)

EN Gas Fry-top smooth POLISHED CHROME, plate cm.76x51 - 2 cooking areas (included 1 Head end filler strip mod.TPA-7) • **DE** Gas-griddleplatte glatt POLIERTEM CHROM, platte cm.76x51 - 2 Heizzonen (inbegriffen 1 Abschluss-Element mod.TPA-7) • **FR** Plaque gaz lisse CHROME POLI, plaque cm.76x51 - 2 zones de cuisson (inclus 1 Élément de jonction top mod.TPA-7) • **ES** Fry-top gas liso CROMO PULIDO, plancha cm.76x51 - 2 zonas de cocción (incluida 1 Chapa de cierre para top mod.TPA-7)
cm. 80x 70,5x 28h

⚡ 14 kW
12.040 kcal/h

4.076,00
108 / 0,35

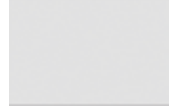

FRY-TOP A GAS - TOP

MOD. _____
COD. _____

DESCRIZIONE/DESCRIPTION/BEZEICHNUNG/DESCRIPTION/DESCRIPCIÓN
DIMENSIONI/DIMENSIONS/ABMESSUNGEN/DIMENSIONS/DIMENSIONES

POTENZA/POWER/LEISTUNG/PUISSANCE/POTENCIA
VOLTAGGIO/VOLTAGE/SPANNUNG/VOLTAGE/VOLTAJE

14 kW
12.040 kcal/h

PREZZO/PRICE
PREIS/PRIX/PRECIO
KG / M³



FTLRT-78G
18230852

FRY-TOP GAS 1/2 RIGATO + 1/2 LISCIO, PIASTRA CM.76X51 - 2 ZONE DI COTTURA (INCLUSA 1 TESTATA CHIUSURA PIANO MOD.TPA-7)

EN Gas Fry-top 1/2 grooved + 1/2 smooth, plate cm.76x51 - 2 cooking areas (included 1 Head end filler strip mod.TPA-7) • **DE** Gas-griddleplatte 1/2 gerillt + 1/2 glatt, platte cm.76x51 - 2 Heizzonen (inbegriffen 1 Abschluss-Element mod.TPA-7) • **FR** Plaque gaz 1/2 nervurée + 1/2 lisse, plaque cm.76x51 - 2 zones de cuisson (inclus 1 Élément de jonction top mod.TPA-7) • **ES** Fry-top gas 1/2 estriado + 1/2 liso, plancha cm.76x51 - 2 zonas de cocción (incluida 1 Chapa de cierre para top mod.TPA-7)

cm. 80x 70,5x 28h



14 kW
12.040 kcal/h

3.461,00
108 / 0,35



FTLRT-78GS
18230855

FRY-TOP GAS 1/2 RIGATO + 1/2 LISCIO CROMATO SUPERCHROME (MOCA APPROVED), PIASTRA CM.76X51 - 2 ZONE DI COTTURA (INCLUSA 1 TESTATA CHIUSURA PIANO MOD.TPA-7)

EN Gas Fry-top 1/2 grooved + 1/2 smooth chromed griddle SUPERCHROME (Moca Approved), plate cm.76x51 - 2 cooking areas (included 1 Head end filler strip mod.TPA-7) • **DE** Gas-griddleplatte 1/2 gerillt + 1/2 glatt hartverchromt SUPERCHROME (Moca Approved), platte cm.76x51 - 2 Heizzonen (inbegriffen 1 Abschluss-Element mod.TPA-7)

• **FR** Plaque gaz 1/2 nervurée + 1/2 lisse chromée SUPERCHROME (Moca Approved), plaque cm.76x51 - 2 zones de cuisson (inclus 1 Élément de jonction top mod.TPA-7) • **ES** Fry-top gas 1/2 estriado + 1/2 liso cromado SUPERCHROME (Moca Approved), plancha cm.76x51 - 2 zonas de cocción (incluida 1 Chapa de cierre para top mod.TPA-7)

cm. 80x 70,5x 28h

14 kW
12.040 kcal/h

4.266,00
108 / 0,35



FRT-78G
18230853

FRY-TOP GAS RIGATO, PIASTRA CM.76X51 - 2 ZONE DI COTTURA (INCLUSA 1 TESTATA CHIUSURA PIANO MOD.TPA-7)

EN Gas Fry-top grooved griddle, plate cm.76x51 - 2 cooking areas (included 1 Head end filler strip mod.TPA-7) • **DE** Gas-griddleplatte gerillt, platte cm.76x51 - 2 Heizzonen (inbegriffen 1 Abschluss-Element mod.TPA-7) • **FR** Plaque gaz nervurée, plaque cm.76x51 - 2 zones de cuisson (inclus 1 Élément de jonction top mod.TPA-7) • **ES** Fry-top gas estriado, plancha cm.76x51 - 2 zonas de cocción (incluida 1 Chapa de cierre para top mod.TPA-7)

cm. 80x 70,5x 28h



14 kW
12.040 kcal/h

3.653,00
108 / 0,35



FRT-78GS
18230856

FRY-TOP GAS RIGATO CROMATO SUPERCHROME (MOCA APPROVED), PIASTRA CM.76X51 - 2 ZONE DI COTTURA (INCLUSA 1 TESTATA CHIUSURA PIANO MOD.TPA-7)

EN Gas Fry-top grooved chromed griddle SUPERCHROME (Moca Approved), plate cm.76x51 - 2 cooking areas (included 1 Head end filler strip mod.TPA-7) • **DE** Gas-griddleplatte gerillt hartverchromt SUPERCHROME (Moca Approved), platte cm.76x51 - 2 Heizzonen (inbegriffen 1 Abschluss-Element mod.TPA-7) • **FR** Plaque gaz nervurée chromée SUPERCHROME (Moca Approved), plaque cm.76x51 - 2 zones de cuisson (inclus 1 Élément de jonction top mod.TPA-7) • **ES** Fry-top gas estriado cromado SUPERCHROME (Moca Approved), plancha cm.76x51 - 2 zonas de cocción (incluida 1 Chapa de cierre para top mod.TPA-7)

cm. 80x 70,5x 28h

14 kW
12.040 kcal/h

4.456,00
108 / 0,35



FTLT-712G
18231251

FRY-TOP GAS LISCIO, PIASTRA CM.116X51 - 2 ZONE DI COTTURA (INCLUSA 1 TESTATA CHIUSURA PIANO MOD.TPA-7)

EN Gas Fry-top smooth griddle, plate cm.116x51 - 2 cooking areas (included 1 Head end filler strip mod.TPA-7) • **DE** Gas-griddleplatte glatt, platte cm.116x51 - 2 Heizzonen (inbegriffen 1 Abschluss-Element mod.TPA-7) • **FR** Plaque gaz lisse, plaque cm.116x51 - 2 zones de cuisson (inclus 1 Élément de jonction top mod.TPA-7) • **ES** Fry-top gas liso, plancha cm.116x51 - 2 zonas de cocción (incluida 1 Chapa de cierre para top mod.TPA-7)

cm. 120x 70,5x 28h



21 kW
18.060 kcal/h

4.328,00
120 / 0,51



FRY-TOP A GAS - TOP

MOD. _____
COD. _____

DESCRIZIONE/DESCRIPTION/BEZEICHNUNG/DESCRIPTION/DESCRIPCIÓN
DIMENSIONI/DIMENSIONS/ABMESSUNGEN/DIMENSIONS/DIMENSIONES

POTENZA/POWER/LEISTUNG/PUISSANCE/POTENCIA
VOLTAGGIO/VOLTAGE/SPANNUNG/VOLTAGE/VOLTAJE

21 kW
18.060 kcal/h

PREZZO/PRICE
PREIS/PRIX/PRECIO
KG / M³



FTLT-712GS
18231254

FRY-TOP GAS LISCIO CROMATO SUPERCHROME (MOCA APPROVED), PIASTRA CM.116X51 - 2 ZONE DI COTTURA (INCLUSA 1 TESTATA CHIUSURA PIANO MOD.TPA-7)

EN Gas Fry-top smooth chromed griddle SUPERCHROME (Moca Approved), plate cm.116x51 - 2 cooking areas (included 1 Head end filler strip mod.TPA-7) • **DE** Gas-griddleplatte glatt hartverchromt SUPERCHROME (Moca Approved), platte cm.116x51 - 2 Heizzonen (inbegriffen 1 Abschluss-Element mod.TPA-7) • **FR** Plaque gaz lisse chromée SUPERCHROME (Moca Approved), plaque cm.116x51 - 2 zones de cuisson (inclus 1 Élément de jonction top mod.TPA-7) • **ES** Fry-top gas liso cromado SUPERCHROME (Moca Approved), plancha cm.116x51 - 2 zonas de cocción (incluida 1 Chapa de cierre para top mod.TPA-7)
cm. 120x 70,5x 28h



21 kW
18.060 kcal/h

5.164,00
120 / 0,51

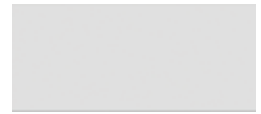

FTLRT-712G
18231252

FRY-TOP GAS 1/2 RIGATO + 1/2 LISCIO, PIASTRA CM.116X51 - 2 ZONE DI COTTURA (INCLUSA 1 TESTATA CHIUSURA PIANO MOD.TPA-7)

EN Gas Fry-top 1/2 grooved + 1/2 smooth, plate cm.116x51 - 2 cooking areas (included 1 Head end filler strip mod.TPA-7) • **DE** Gas-griddleplatte 1/2 gerillt + 1/2 glatt, platte cm.116x51 - 2 Heizzonen (inbegriffen 1 Abschluss-Element mod.TPA-7) • **FR** Plaque gaz 1/2 nervurée + 1/2 lisse, plaque cm.116x51 - 2 zones de cuisson (inclus 1 Élément de jonction top mod.TPA-7) • **ES** Fry-top gas 1/2 estriado + 1/2 liso, plancha cm.116x51 - 2 zonas de cocción (incluida 1 Chapa de cierre para top mod.TPA-7)
cm. 120x 70,5x 28h



21 kW
18.060 kcal/h

4.560,00
120 / 0,51



FTLRT-712GS
18231255

FRY-TOP GAS 1/2 RIGATO + 1/2 LISCIO CROMATO SUPERCHROME (MOCA APPROVED), PIASTRA CM.116X51 - 2 ZONE DI COTTURA (INCLUSA 1 TESTATA CHIUSURA PIANO MOD.TPA-7)

EN Gas Fry-top 1/2 grooved + 1/2 smooth chromed griddle SUPERCHROME (Moca Approved), plate cm.116x51 - 2 cooking areas (included 1 Head end filler strip mod.TPA-7) • **DE** Gas-griddleplatte 1/2 gerillt + 1/2 glatt hartverchromt SUPERCHROME (Moca Approved), platte cm.116x51 - 2 Heizzonen (inbegriffen 1 Abschluss-Element mod.TPA-7) • **FR** Plaque gaz 1/2 nervurée + 1/2 lisse chromée SUPERCHROME (Moca Approved), plaque cm.116x51 - 2 zones de cuisson (inclus 1 Élément de jonction top mod.TPA-7) • **ES** Fry-top gas 1/2 estriado + 1/2 liso cromado SUPERCHROME (Moca Approved), plancha cm.116x51 - 2 zonas de cocción (incluida 1 Chapa de cierre para top mod.TPA-7)
cm. 120x 70,5x 28h

21 kW
18.060 kcal/h

5.352,00
120 / 0,51



FTRT-712G
18231253

FRY-TOP GAS RIGATO, PIASTRA CM.116X51 - 2 ZONE DI COTTURA (INCLUSA 1 TESTATA CHIUSURA PIANO MOD.TPA-7)

EN Gas Fry-top grooved griddle, plate cm.116x51 - 2 cooking areas (included 1 Head end filler strip mod.TPA-7) • **DE** Gas-griddleplatte gerillt, platte cm.116x51 - 2 Heizzonen (inbegriffen 1 Abschluss-Element mod.TPA-7) • **FR** Plaque gaz nervurée, plaque cm.116x51 - 2 zones de cuisson (inclus 1 Élément de jonction top mod.TPA-7) • **ES** Fry-top gas estriado, plancha cm.116x51 - 2 zonas de cocción (incluida 1 Chapa de cierre para top mod.TPA-7)
cm. 120x 70,5x 28h



21 kW
18.060 kcal/h

4.794,00
120 / 0,51



FTRT-712GS
18231256

FRY-TOP GAS RIGATO CROMATO SUPERCHROME (MOCA APPROVED), PIASTRA CM.116X51 - 2 ZONE DI COTTURA (INCLUSA 1 TESTATA CHIUSURA PIANO MOD.TPA-7)

EN Gas Fry-top grooved chromed griddle SUPERCHROME (Moca Approved), plate cm.116x51 - 2 cooking areas (included 1 Head end filler strip mod.TPA-7) • **DE** Gas-griddleplatte gerillt hartverchromt SUPERCHROME (Moca Approved), platte cm.116x51 - 2 Heizzonen (inbegriffen 1 Abschluss-Element mod.TPA-7) • **FR** Plaque gaz nervurée chromée SUPERCHROME (Moca Approved), plaque cm.116x51 - 2 zones de cuisson (inclus 1 Élément de jonction top mod.TPA-7) • **ES** Fry-top gas estriado cromado SUPERCHROME (Moca Approved), plancha cm.116x51 - 2 zonas de cocción (incluida 1 Chapa de cierre para top mod.TPA-7)
cm. 120x 70,5x 28h

21 kW
18.060 kcal/h

5.598,00
120 / 0,51



FRY-TOP A GAS - TOP

MOD. _____
COD. _____

DESCRIZIONE/DESCRIPTION/BEZEICHNUNG/DESCRIPTION/DESCRIPCIÓN
DIMENSIONI/DIMENSIONS/ABMESSUNGEN/DIMENSIONS/DIMENSIONES

POTENZA/POWER/LEISTUNG/PUISSANCE/POTENCIA
VOLTAGGIO/VOLTAGE/SPANNUNG/VOLTAGE/VOLTAJE

21 kW
18.060 kcal/h

PREZZO/PRICE
PREIS/PRIX/PRECIO
KG / M³



FTLT-712G3 FRY-TOP GAS LISCIO, PIASTRA CM.116X51 - 3 ZONE DI COTTURA (INCLUSA 1 TESTATA CHIUSURA PIANO MOD. TPA-7)
1823125B

EN Gas Fry-top smooth griddle, plate cm.116x51 - 3 cooking areas (included 1 Head end filler strip mod.TPA-7) • **DE** Gas-griddleplatte glatt, platte cm.116x51 - 3 Heizzonen (inbegriffen 1 Abschluss-Element mod. TPA-7) • **FR** Plaque gaz lisse, plaque cm.116x51 - 3 zones de cuisson (inclus 1 Élément de jonction top mod.TPA-7) • **ES** Fry-top gas liso, plancha cm.116x51 - 3 zonas de cocción (incluida 1 Chapa de cierre para top mod.TPA-7)
cm. 120x 70,5x 28h



21 kW
18.060 kcal/h

4.702,00
120 / 0,51

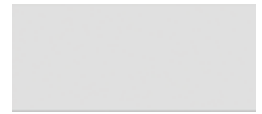

FTLT-712GS3 FRY-TOP GAS LISCIO CROMATO SUPERCHROME (MOCA APPROVED), PIASTRA CM.116X51 - 3 ZONE DI COTTURA (INCLUSA 1 TESTATA CHIUSURA PIANO MOD.TPA-7)
1823125E

EN Gas Fry-top smooth chromed griddle SUPERCHROME (Moca Approved), plate cm.116x51 - 3 cooking areas (included 1 Head end filler strip mod.TPA-7) • **DE** Gas-griddleplatte glatt hartverchromt SUPERCHROME (Moca Approved), platte cm.116x51 - 3 Heizzonen (inbegriffen 1 Abschluss-Element mod.TPA-7) • **FR** Plaque gaz lisse chromée SUPERCHROME (Moca Approved), plaque cm.116x51 - 3 zones de cuisson (inclus 1 Élément de jonction top mod.TPA-7) • **ES** Fry-top gas liso cromado SUPERCHROME (Moca Approved), plancha cm.116x51 - 3 zonas de cocción (incluida 1 Chapa de cierre para top mod.TPA-7)
cm. 120x 70,5x 28h

21 kW
18.060 kcal/h

5.494,00
120 / 0,51

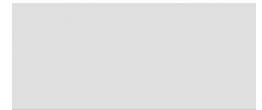

FTLT-712GSS3 FRY-TOP GAS LISCIO CROMO LUCIDO, PIASTRA CM.116X51 - 3 ZONE DI COTTURA (INCLUSA 1 TESTATA CHIUSURA PIANO MOD.TPA-7)
1823125Y

EN Gas Fry-top smooth POLISHED CHROME, plate cm.116x51 - 3 cooking areas (included 1 Head end filler strip mod.TPA-7) • **DE** Gas-griddleplatte glatt POLIERTEM CHROM, platte cm.116x51 - 3 Heizzonen (inbegriffen 1 Abschluss-Element mod.TPA-7) • **FR** Plaque gaz lisse CHROME POLI, plaque cm.116x51 - 3 zones de cuisson (inclus 1 Élément de jonction top mod.TPA-7) • **ES** Fry-top gas liso CROMO PULIDO, plancha cm.116x51 - 3 zonas de cocción (incluida 1 Chapa de cierre para top mod.TPA-7)
cm. 120x 70,5x 28h

21 kW
18.060 kcal/h

5.494,00
120 / 0,51

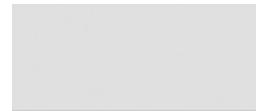

FTLRT-712G3 FRY-TOP GAS 1/3 RIGATO + 2/3 LISCIO, PIASTRA CM.116X51 - 3 ZONE DI COTTURA (INCLUSA 1 TESTATA CHIUSURA PIANO MOD.TPA-7)
1823125C

EN Gas Fry-top 1/3 grooved + 2/3 smooth, plate cm.116x51 - 3 cooking areas (included 1 Head end filler strip mod.TPA-7) • **DE** Gas-griddleplatte 1/3 gerillt + 2/3 glatt, platte cm.116x51 - 3 Heizzonen (inbegriffen 1 Abschluss-Element mod.TPA-7) • **FR** Plaque gaz 1/3 nervurée + 2/3 lisse, plaque cm.116x51 - 3 zones de cuisson (inclus 1 Élément de jonction top mod.TPA-7) • **ES** Fry-top gas 1/3 estriado + 2/3 liso, plancha cm.116x51 - 3 zonas de cocción (incluida 1 Chapa de cierre para top mod.TPA-7)
cm. 120x 70,5x 28h



21 kW
18.060 kcal/h

4.822,00
120 / 0,51



FTLRT-712GS3 FRY-TOP GAS 1/3 RIGATO + 2/3 LISCIO CROMATO SUPERCHROME (MOCA APPROVED), PIASTRA CM.116X51 - 3 ZONE DI COTTURA (INCLUSA 1 TESTATA CHIUSURA PIANO MOD.TPA-7)
1823125F

EN Gas Fry-top 1/3 grooved + 2/3 smooth chromed griddle SUPERCHROME (Moca Approved), plate cm.116x51 - 3 cooking areas (included 1 Head end filler strip mod.TPA-7) • **DE** Gas-griddleplatte 1/3 gerillt + 2/3 glatt hartverchromt SUPERCHROME (Moca Approved), platte cm.116x51 - 3 Heizzonen (inbegriffen 1 Abschluss-Element mod.TPA-7) • **FR** Plaque gaz 1/3 nervurée + 2/3 lisse chromée SUPERCHROME (Moca Approved), plaque cm.116x51 - 3 zones de cuisson (inclus 1 Élément de jonction top mod.TPA-7) • **ES** Fry-top gas 1/3 estriado + 2/3 liso cromado SUPERCHROME (Moca Approved), plancha cm.116x51 - 3 zonas de cocción (incluida 1 Chapa de cierre para top mod.TPA-7)
cm. 120x 70,5x 28h

21 kW
18.060 kcal/h

5.682,00
120 / 0,51



GRIGLIE ELETTRICHE - TOP

MOD. _____
COD. _____

DESCRIZIONE/DESCRIPTION/BEZEICHNUNG/DESCRIPTION/DESCRIPCIÓN
DIMENSIONI/DIMENSIONS/ABMESSUNGEN/DIMENSIONS/DIMENSIONES

POTENZA/POWER/LEISTUNG/PUISSANCE/POTENCIA
VOLTAGGIO/VOLTAGE/SPANNUNG/VOLTAGE/VOLTAJE

⚡ kW _____
kcal/h _____
V~ _____
Hz _____

PREZZO/PRICE
PREIS/PRIX/PRECIO
KG / M³



CWKT-74ET **GRIGLIA CONTACT - COTTURA DIRETTA SU RESISTENZA IN ACCIAIO INOX CM. 27X43 RIBALTABILE (INCLUSA 1 TESTATA CHIUSURA PIANO MOD.TPA-7)**
18080431
EN CONTACT Grill threephase - rotatable stainless steel grill cm. 27x43 (included 1 Head end filler strip mod.TPA-7) • **DE** Wurstbrater dreiphasig KONTAKT - Drehbaren Heizelement aus Edelstahl cm. 27x43 (inbegriffen 1 Abschluss-Element mod.TPA-7) • **FR** Grillade triphase CONTACT - Grille inox rotatif cm 27x43 (inclus 1 Élément de jonction top mod.TPA-7) • **ES** Parrilla trifásico CONTACT - Parrilla giratoria de acero inox cm 27x43 (incluida 1 Chapa de cierre para top mod.TPA-7)
cm. 40x 70,5x 28h



⚡ 4,08 kW _____ **2.855,00**
400V~3N _____ 55 / 0,18
50/60 Hz

CWKT-78ET **GRIGLIA CONTACT - COTTURA DIRETTA SU RESISTENZA IN ACCIAIO INOX CM. 55X43 RIBALTABILE - 2 ZONE COTTURA (INCLUSA 1 TESTATA CHIUSURA PIANO MOD.TPA-7)**
18080831
EN CONTACT Grill threephase - rotatable stainless steel grill cm. 55x43 - 2 cooking areas (included 1 Head end filler strip mod.TPA-7) • **DE** Wurstbrater dreiphasig KONTAKT - Drehbaren Heizelement aus Edelstahl cm. 55x43 - 2 Heizzonen (inbegriffen 1 Abschluss-Element mod.TPA-7) • **FR** Grillade triphase CONTACT - Grille inox rotatif cm 55x43 - 2 zones de cuisson (inclus 1 Élément de jonction top mod.TPA-7) • **ES** Parrilla trifásico CONTACT - Parrilla giratoria de acero inox cm 55x43 - 2 zonas de cocción (incluida 1 Chapa de cierre para top mod.TPA-7)
cm. 80x 70,5x 28h



⚡ 8,16 kW _____ **3.854,00**
400V~3N _____ 85 / 0,35
50/60 Hz

CWT-74ET **GRIGLIA TRIFASE GRIGLIA IN ACCIAIO INOX CM. 38X52 REGOLABILE (INCLUSA 1 TESTATA CHIUSURA PIANO MOD. TPA-7)**
18080430
EN Grill threephase - Stainless steel grill cm. 38x52 (included 1 Head end filler strip mod.TPA-7) • **DE** Wurstbrater dreiphasig - Einstellbarer Rost aus Nirosta cm. 38x52 (inbegriffen 1 Abschluss-Element mod.TPA-7) • **FR** Grillade triphase - Grille inox cm 38x52 (inclus 1 Élément de jonction top mod.TPA-7) • **ES** Parrilla trifásico - Parrilla de acero inox regulable cm 38x52 (incluida 1 Chapa de cierre para top mod.TPA-7)
cm. 40x 70,5x 28h



⚡ 6 kW _____ **2.060,00**
400V~3N _____ 57 / 0,18
230V~3 _____
50/60 Hz

CWT-78ET **GRIGLIA TRIFASE N. 2 GRIGLIE IN ACCIAIO INOX CM. 38X52 REGOLABILI 2 ZONE DI COTTURA (INCLUSA 1 TESTATA CHIUSURA PIANO MOD.TPA-7)**
18080830
EN Grill threephase - N. 2 Stainless steel grill cm. 38x52. 2 cooking areas (included 1 Head end filler strip mod.TPA-7) • **DE** Wurstbrater dreiphasig - N. 2 einstellbare Roste aus Nirosta cm. 38x52 - 2 Heizzonen (inbegriffen 1 Abschluss-Element mod.TPA-7) • **FR** Grillade triphase - N. 2 grilles réglables en acier inox cm. 38x52 - 2 zones de cuisson (inclus 1 Élément de jonction top mod.TPA-7) • **ES** Parrilla trifásico - N. 2 Parrillas de acero inox regulable cm 38x52 - 2 zonas de cocción (incluida 1 Chapa de cierre para top mod.TPA-7)
cm. 80x 70,5x 28h



⚡ 12 kW _____ **3.109,00**
400V~3N _____ 87 / 0,35
230V~3 _____
50/60 Hz

CWT-74G **GRIGLIA GAS-PIETRALAVICA GRIGLIA IN ACCIAIO INOX CM. 38X52 REGOLABILE (INCLUSA 1 TESTATA CHIUSURA PIANO MOD.TPA-7)**
18250450
EN Charcoal grill gas - Stainless steel grill cm. 38x52 (included 1 Head end filler strip mod.TPA-7) • **DE** Gas-Lavasteingrill - Einstellbarer Rost aus Nirosta cm. 38x52 (inbegriffen 1 Abschluss-Element mod.TPA-7) • **FR** Grille à gaz en pierre de lave - Grille inox cm 38x52 (inclus 1 Élément de jonction top mod.TPA-7) • **ES** Parrilla a gas piedra lávica - Parrilla de acero inox regulable cm 38x52 (incluida 1 Chapa de cierre para top mod.TPA-7)
cm. 40x 70,5x 28h



⚡ 9 kW _____ **2.178,00**
7.740 kcal/h _____ 56 / 0,21

CWT-78G **GRIGLIA GAS-PIETRALAVICA N. 2 GRIGLIE IN ACCIAIO INOX CM. 38X52 REGOLABILI 2 ZONE DI COTTURA (INCLUSA 1 TESTATA CHIUSURA PIANO MOD.TPA-7)**
18250850
EN Charcoal grill gas - N. 2 Stainless steel grill cm. 38x52 2 cooking areas (included 1 Head end filler strip mod.TPA-7) • **DE** Gas-Lavasteingrill - N. 2 einstellbare Roste aus Nirosta cm. 38x52 - 2 Heizzonen (inbegriffen 1 Abschluss-Element mod.TPA-7) • **FR** Grille a gaz en pierre de lave - N. 2 grilles réglables en acier inox cm. 38x52 - 2 zones de cuisson (inclus 1 Élément de jonction top mod.TPA-7) • **ES** Parrilla a gas piedra lávica - N. 2 Parrillas de acero inox regulable cm 38x52 - 2 zonas de cocción (incluida 1 Chapa de cierre para top mod. TPA-7)
cm. 80x 70,5x 28h



⚡ 18 kW _____ **3.398,00**
15.480 kcal/h _____ 97 / 0,40

FRIGGITRICI ELETTRICHE - TOP

MOD. _____
COD. _____

DESCRIZIONE/DESCRIPTION/BEZEICHNUNG/DESCRIPTION/DESCRIPCIÓN
DIMENSIONI/DIMENSIONS/ABMESSUNGEN/DIMENSIONS/DIMENSIONES

POTENZA/POWER/LEISTUNG/PUISSANCE/POTENCIA
VOLTAGGIO/VOLTAGE/SPANNUNG/VOLTAGE/VOLTAJE

⚡ kcal/h
⚡ kW
V~
Hz

PREZZO/PRICE
PREIS/PRIX/PRECIO
KG / M³



F2/8T-74ET
18090432

FRIGGITRICE TRIFASE LT. 8+8 2 VASCHE CM. 14,8X35,5X22,5H - 2 CESTI CM. 12X29X11,5H - FILTRO E COPERCHIO VASCA. PRODUZIONE PATATE: 12 KG/H (INCLUSA 1 TESTATA CHIUSURA PIANO MOD.TPA-7)
EN Fryer threephase 8+8 lts - 2 Bowls cm. 14,8x35,5x22,5h - 2 baskets cm. 12x29x11,5h. Sieve and lid for pan. Production: 12 kg/h (included 1 Head end filler strip mod.TPA-7) • **DE** Friteuse dreiphasig lt. 8+8 - 2 Becken cm. 14,8x35,5x22,5h - 2 Korb cm. 12x29x11,5h. Einlegesieb und Deckel für Becken. Pommes frites: 12 kg/h (inbegriffen 1 Abschluss-Element mod.TPA-7) • **FR** Friteuse triphase lt. 8+8 - 2 Cuve cm. 14,8x35,5x22,5h - 2 Panier cm. 12x29x11,5h. Filtre, couvercle pour cuve. Production de pommes frites: 12 kg/h (inclus 1 Elément de jonction top mod.TPA-7) • **ES** Freidoras trifásico 8+8 lt. - 2Cuba cm. 14,8x35,5x22,5h- 2 cesta cm. 12x29x11,5h. Filtro y tapa para cuba. Prod. patatas: 12 Kg/h (incluida 1 Chapa de cierre para top mod.TPA-7)
cm. 40x 70,5x 28h



⚡ 12 kW
400V~3N
230V~3
50/60 Hz

3.065,00
50 / 0,18

F13T-74ET
18090430

FRIGGITRICE TRIFASE LT. 13 VASCA CM. 30,5X34X22,5H - 1 CESTO CM. 28X29X10H FILTRO E COPERCHIO VASCA - PRODUZIONE PATATE: 10 KG/H (INCLUSA 1 TESTATA CHIUSURA PIANO MOD.TPA-7)
EN Fryer threephase 13 lts - Bowl cm. 30,5x34x22,5h 1 basket cm. 28x29x10h - Sieve and lid for pan Production: 10 kg/h (included 1 Head end filler strip mod.TPA-7) • **DE** Friteuse dreiphasig lt. 13 - Becken cm. 30,5x34x22,5h - 1 Korb cm. 28x29x10h - Einlegesieb und Deckel für Becken - Pommes frites: 10 kg/h (inbegriffen 1 Abschluss-Element mod.TPA-7) • **FR** Friteuse triphase lt. 13 - Cuve cm. 30,5x34x22,5h - 1 Panier cm. 28x29x10h - Filtre, couvercle pour cuve Production de pommes frites: 10 kg/h (inclus 1 Elément de jonction top mod.TPA-7) • **ES** Freidoras trifásico 13 lt. - Cuba cm. 30,5x34x22,5h - 1 cesta cm. 28x29x10h - Filtro y tapa para cuba. Prod. patatas: 10 Kg/h (incluida 1 Chapa de cierre para top mod.TPA-7)
cm. 40x 70,5x 28h



⚡ 10,95 kW
400V~3N
50/60 Hz

2.169,00
48 / 0,18

F2/13T-78ET
18090830

FRIGGITRICE TRIFASE LT. 13+13 2 VASCHE CM. 30,5X34X22,5H - 2 CESTI CM. 28X29X10H 2 FILTRI E COPERCHI VASCHE - PRODUZIONE PATATE: 20 KG/H (INCLUSA 1 TESTATA CHIUSURA PIANO MOD.TPA-7)
EN Fryer threephase 13+13 lts - 2 pans cm. 30,5x34x22,5h 2 baskets cm. 28x29x10h - 2 sieves and lids for pan Production: 20 kg/h (included 1 Head end filler strip mod.TPA-7) • **DE** Friteuse dreiphasig lt. 13+13 - 2 Becken cm. 30,5x34x22,5h 2 Körbe cm. 28x29x10h - Einlegesieb und Deckel für Becken - Pommes frites: 20 kg/h (inbegriffen 1 Abschluss-Element mod.TPA-7) • **FR** Friteuse triphase lt. 13+13 - 2 cuves cm. 30,5x34x22,5h 2 paniers cm. 28x29x10h - 2 filtres, couvercles pour cuve Production de pommes frites: 20 kg/h (inclus 1 Elément de jonction top mod.TPA-7) • **ES** Freidoras trifásico 13+13 lt. - 2 cubas cm. 30,5x34x22,5h - 2 cestas cm. 28x29x10h . 2 filtros y tapas para cubas Prod. patatas: 20 Kg/h (incluida 1 Chapa de cierre para top mod.TPA-7)
cm. 80x 70,5x 28h



⚡ 21,9 kW
400V~3N
50/60 Hz

3.437,00
75 / 0,35

F2/8T-74G
18260452

FRIGGITRICE GAS LT. 8+8 - 2 VASCHE CM. 15X35X23H 2 CESTI CM. 12X30X9,5H. FILTRO E COPERCHIO VASCA. PROD. PATATE: 12 KG/H (INCLUSA 1 TESTATA CHIUSURA PIANO MOD.TPA-7)
EN Gas Fryer 8+8 lts - 2 pans cm. 15x35x23h 2 baskets cm. 12x30x9,5h. Sieve and lid for pan. Production: 12 kg/h (included 1 Head end filler strip mod.TPA-7) • **DE** Gas-Friteuse lt. 8+8 - 2 Becken cm. 15x35x23h 2 Körbe cm. 12x30x9,5h. Einlegesieb und Deckel für Becken. Pommes frites: 12 kg/h (inbegriffen 1 Abschluss-Element mod.TPA-7) • **FR** Friteuse à gaz lt. 8+8 - 2 cuves cm. 15x35x23h 2 paniers cm. 12x30x9,5h.Filtre, couvercle pour cuve. Production de pommes frites: 12 kg/h (inclus 1 Elément de jonction top mod.TPA-7) • **ES** Freidoras a gas 8+8 lt. - 2 cubas cm. 15x35x23h 2 cestas cm. 12x30x9,5h. Filtro y tapa para cuba. Prod. patatas: 12 Kg/h (incluida 1 Chapa de cierre para top mod.TPA-7)
cm. 40x 70,5x 28h



⚡ 9 kW
7.740 kcal/h

3.557,00
50 / 0,18

FRIGGITRICI A GAS - TOP

MOD. _____
COD. _____

DESCRIZIONE/DESCRIPTION/BEZEICHNUNG/DESCRIPTION/DESCRIPCIÓN
DIMENSIONI/DIMENSIONS/ABMESSUNGEN/DIMENSIONS/DIMENSIONES

POTENZA/POWER/LEISTUNG/PUISSANCE/POTENCIA
VOLTAGGIO/VOLTAGE/SPANNUNG/VOLTAGE/VOLTAJE

⚡ kW
kcal/h

PREZZO/PRICE
PREIS/PRIX/PRECIO
KG / M³



F13T-74G
18260450

**FRIGGITRICE GAS LT. 13 - VASCA CM. 31,5X34,5X22,5H
1 CESTO CM. 28X29X10H - FILTRO E COPERCHIO VASCA.
PROD. PATATE: 10 KG/H (INCLUSA 1 TESTATA CHIUSURA
PIANO MOD.TPA-7)**

EN Gas Fryer 13 lts - Bowl cm. 31,5x34,5x22,5h - 1 basket cm. 28x29x10h - Sieve and lid for pan Production: 10 kg/h (included 1 Head end filler strip mod.TPA-7) • **DE** Gas-Friteuse lt. 13 - Becken cm. 31,5x34,5x22,5h - 1 Korb cm. 28x29x10h - Einlegesieb und Deckel für Becken - Pommes frites: 10 kg/h (inbegriffen 1 Abschluss-Element mod.TPA-7) • **FR** Friteuse à gaz lt. 13 - Cuve cm. 31,5x34,5x22,5h - 1 Panier cm. 28x29x10h - Filtre, couvercle pour cuve Production de pommes frites: 10 kg/h (inclus 1 Élément de jonction top mod.TPA-7) • **ES** Freidoras a gas 13 lt. - Cuba cm. 31,5x34,5x22,5h - 1 cesta cm. 28x29x10h - Filtro y tapa para cuba Prod. patatas: 10 Kg/h (incluida 1 Chapa de cierre para top mod.TPA-7)
cm. 40x 70,5x 28h



⚡ 12 kW
10.320 kcal/h

2.384,00
55 / 0,18

F2/13T-78G
18260850

**FRIGGITRICE GAS LT. 13+13 2 VASCHE CM.
31,5X34,5X22,5H - 2 CESTI CM. 28X29X10H 2 FILTRI E
COPERCHI VASCHE - PROD. PATATE: 20 KG/H (INCLUSA 1
TESTATA CHIUSURA PIANO MOD.TPA-7)**

EN Gas Fryer 13+13 lts - 2 pans cm. 31,5x34,5x22,5h 2 baskets cm. 28x29x10h - 2 sieves and lids for pan Production: 20 kg/h (included 1 Head end filler strip mod.TPA-7) • **DE** Gas-Friteuse lt. 13+13 - 2 Becken cm. 31,5x34,5x22,5h 2 Körbe cm. 28x29x10h - Einlegesieb und Deckel für Becken - Pommes frites: 20 kg/h (inbegriffen 1 Abschluss-Element mod.TPA-7) • **FR** Friteuse à gaz lt. 13+13 - 2 cuves cm. 31,5x34,5x22,5h 2 paniers cm. 28x29x10h - 2 filtres, couvercles pour cuve Production de pommes frites: 20 kg/h (inclus 1 Élément de jonction top mod.TPA-7) • **ES** Freidoras a gas 13+13 lt. - 2 cubas cm. 31,5x34,5x22,5h 2 cestas cm. 28x29x10h - 2 filtros y tapas para cubas. Prod. patatas: 20 Kg/h (incluida 1 Chapa de cierre para top mod.TPA-7)
cm. 80x 70,5x 28h



⚡ 24 kW
20.640 kcal/h

3.787,00
81 / 0,35

MFV-78ET
08490830

**BASE CON FORNO ELETTRICO VENTILATO CM. 55X36X34H,
TEMP: 50÷300°C, CON 1 GRIGLIA CM.53X32,5 GN1/1
(NON SOVRAPPORRE ELEMENTI AD INDUZIONE)**

EN Stand with electric fan oven cm. 55x36x34h, temp: 50÷300°C, with 1 grid cm.53x32,5 GN1/1 (no induction top) • **DE** unterbau mit Elektro-Heißluftofen cm. 55x36x34h, temp: 50÷300°C, mit 1 Rost cm.53x32,5 GN1/1 (nicht Induktions) • **FR** placard avec Four à chaleur tournante électrique cm. 55x36x34h, temp: 50÷300°C, avec 1 grille cm.53x32,5 GN1/1 (il faut pas de induction) • **ES** mueble con Horno eléctrico ventilado cm. 55x36x34h, temp: 50÷300°C, con 1 parilla cm.53x32,5 GN1/1 (no inducción)
cm. 80x 63x 57h



⚡ 5,32 kW
400V~3N
230V~3
50/60 Hz

3.450,00
55 / 0,49

MF-710ET
08491030

**BASE CON FORNO ELETTRICO STATICO CM. 67X55X34H,
TEMP: 50÷300°C, CON 1 GRIGLIA CM.65X53 GN2/1 (NON
SOVRAPPORRE ELEMENTI AD INDUZIONE)**

EN Stand with traditional electric oven cm. 67x55x34h, temp: 50÷300°C, with 1 grid cm.65x53 GN2/1 (no induction top) • **DE** unterbau mit Statischer Elektro-Backofen cm. 67x55x34h, temp: 50÷300°C, mit 1 Rost cm.65x53 GN2/1 (nicht Induktions) • **FR** placard avec Four électrique statique cm. 67x55x34h, temp: 50÷300°C, avec 1 grille cm.65x53 GN2/1 (il faut pas de induction) • **ES** mueble con Horno eléctrico estático cm. 67x55x34h, temp: 50÷300°C, con 1 parilla cm.65x53 GN2/1 (no inducción)
cm. 100x 63x 57h

⚡ 5 kW
400V~3N
50/60 Hz

3.261,00
60 / 0,73

CMF-78
08490800

COPERCHIO PER MFV-78E

EN Lid for MFV-78E • **DE** Berichterstattung für MFV-78E • **FR** Couvercle pour MFV-78E • **ES** cubertura para MFV-78E
cm. 80x 62,5x 2,8h

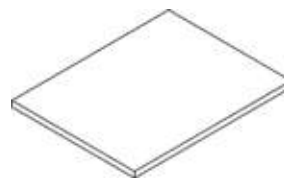

243,00
5 / 0,03

CMF-710
08491000

COPERCHIO PER MF-710E

EN Lid for MF-710E • **DE** Berichterstattung für MF-710E • **FR** Couvercle pour MF-710E • **ES** cubertura para MF-710E
cm. 100x 62,5x 2,8h

294,00
6 / 0,03

MOBILI BASE

MOD. _____
COD. _____

DESCRIZIONE/DESCRIPTION/BEZEICHNUNG/DESCRIPTION/DESCRIPCIÓN
DIMENSIONI/DIMENSIONS/ABMESSUNGEN/DIMENSIONS/DIMENSIONES

POTENZA/POWER/LEISTUNG/PUISSANCE/POTENCIA
VOLTAGGIO/VOLTAGE/SPANNUNG/VOLTAGE/VOLTAJE

⚡ kW kcal/h
⚡ kw V~ Hz

PREZZO/PRICE
PREIS/PRIX/PRECIO
KG / M³



MPI-74
08410403

BASE CON PORTA PER INDUZIONE
EN Stand with door for induction top • **DE** Unterbau für Induktions mit Tür • **FR** Placard pour induction avec porte • **ES** Mueble base para inducción con puerta
cm. 40x 62x 57h



671,00
20 / 0,21

MPI-78
08410803

cm. 80x 62x 57h



759,00
27 / 0,40

M-72
08410200

BASE NEUTRA
EN Stand • **DE** Unterbau • **FR** Placard • **ES** Mueble base
cm. 20x 59,5x 57h



408,00
12 / 0,17

M-73
08410300

BASE NEUTRA A GIORNO
EN Open Stand • **DE** Offener Unterbau • **FR** Placard ouvert • **ES** Mueble base abierto
cm. 30x 59,5x 57h



413,00
14 / 0,21

M-74
08410400

cm. 40x 59,5x 57h



419,00
17 / 0,21

M-76
08410600

cm. 60x 59,5x 57h



470,00
21 / 0,31

M-78
08410800

cm. 80x 59,5x 57h



505,00
24 / 0,40

M-712
08411200

cm. 120x 59,5x 57h

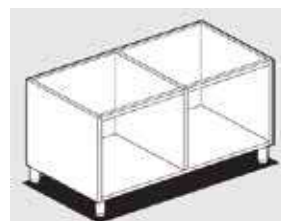

713,00
35 / 0,40

M-716
08411600

cm. 160x 59,5x 57h

852,00
52 / 0,79

MOD. _____
COD. _____

DESCRIZIONE/DESCRIPTION/BEZEICHNUNG/DESCRIPTION/DESCRIPCIÓN
DIMENSIONI/DIMENSIONS/ABMESSUNGEN/DIMENSIONS/DIMENSIONES

POTENZA/POWER/LEISTUNG/PUISSANCE/POTENCIA
VOLTAGGIO/VOLTAGE/SPANNUNG/VOLTAGE/VOLTAJE

⚡ kW kcal/h
⚡ kw V~ Hz

PREZZO/PRICE
PREIS/PRIX/PRECIO
KG / M³



PM-63/73/93-DX PORTA 300 DESTRA
08430302 **EN** Right door 300 • **DE** Rechte tür 300 • **FR** Porte droite 300 • **ES**
Puerta derecha 300
cm. 29,5x 2,5x 47,5h



197,00
3 / 0,01

PM-64/74/94-DX PORTA 400 DESTRA
08430402 **EN** Right door 400 • **DE** Rechte tür 400 • **FR** Porte droite 400 • **ES**
Puerta derecha 400
cm. 39,5x 2,5x 47,5h



204,00
3.5 / 0,02

PM-63/73/93-SX PORTA 300 SINISTRA
08430303 **EN** Left door 300 • **DE** Linke tür 300 • **FR** Porte gauche 300 • **ES**
Puerta izquiera 300
cm. 29,5x 2,5x 47,5h

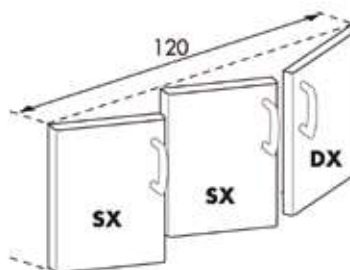

197,00
3 / 0,01

PM-64/74/94-SX PORTA 400 SINISTRA
08430403 **EN** Left door 400 • **DE** Linke tür 400 • **FR** Porte gauche 400 • **ES**
Puerta izquiera 400
cm. 39,5x 2,5x 47,5h

204,00
3.5 / 0,02

C-73/93 CASSETTIERA 300 N. 2 CASSETTI CON 2 BACINELLE INOX, GUIDE TELESCOPICHE.
08440320 **EN** Drawer set 300 N. 2 drawers with 2 inox containers, telescopic guides. • **DE** Schubladen 300 - N. 2 Schubladen mit 2 Chromnickelstahlbehältern, Teleskopeinführungen. • **FR** Tiroirs pour meuble de 300 N. 2 tiroirs avec 2 bacs inox, guides télescopiques. • **ES** Cajonera 300 - N. 2 cajones con 2 contenedores de acero inox, guías telescópicas.
cm. 29,5x 59x 47,5h



766,00
16 / 0,19

C-74/94 CASSETTIERA 400 - N. 2 CASSETTI CON 2 BACINELLE GN 1/1 15H IN PLASTICA, GUIDE TELESCOPICHE.
08440420 **EN** Drawer set 400 - N. 2 drawers with 2 GN 1/1 15h plastic containers, telescopic guides. • **DE** Schubladen - N. 2 Schubladen mit 2 GN 1/1 15h Kunststoffbehältern, Teleskopeinführungen. • **FR** Tiroirs pour meuble de 400 - N. 2 tiroirs avec 2 bacs en plastique GN 1/1 15h, guides télescopiques. • **ES** Cajonera 400 - N. 2 cajones con 2 contenedores GN 1/1 15h de plástico, guías telescópicas.
cm. 39,5x 59x 47,5h



786,00
18 / 0,19

C-76/96 CASSETTIERA 600 N. 2 CASSETTI CON 2 BACINELLE INOX, GUIDE TELESCOPICHE.
08440620 **EN** Drawer set 600 N. 2 drawers with 2 inox containers, telescopic guides. • **DE** Schubladen 600 - N. 2 Schubladen mit 2 Chromnickelstahlbehältern, Teleskopeinführungen. • **FR** Tiroirs pour meuble de 600 N. 2 tiroirs avec 2 bacs inox, guides télescopiques. • **ES** Cajonera 600 - N. 2 cajones con 2 contenedores de acero inox, guías telescópicas.
cm. 59,5x 59x 47,5h



1.086,00
22 / 0,28

ACCESSORI TOP

MOD. _____
COD. _____

DESCRIZIONE/DESCRIPTION/BEZEICHNUNG/DESCRIPTION/DESCRIPCIÓN
DIMENSIONI/DIMENSIONS/ABMESSUNGEN/DIMENSIONS/DIMENSIONES

POTENZA/POWER/LEISTUNG/PUISSANCE/POTENCIA
VOLTAGGIO/VOLTAGE/SPANNUNG/VOLTAGE/VOLTAJE

⚡ kW kcal/h
⚡ kW V~ Hz

PREZZO/PRICE
PREIS/PRIX/PRECIO
KG / M³



C-78/98
08440820

CASSETTIERA 800 - N. 2 CASSETTI CON 4 BACINELLE GN 1/1 15H IN PLASTICA, GUIDE TELESCOPICHE.

EN Drawer set 800 - N. 2 drawers with 4 GN 1/1 15h plastic containers, telescopic guides. • **DE** Schubladen 800 - N. 2 Schubladen mit 4 GN 1/1 15h Kunststoffbehältern, Telescopeinführungen. • **FR** Tiroirs pour meuble de 800 - N. 2 tiroirs avec 4 bacs en plastique GN 1/1 15h, guides télescopiques. • **ES** Cajonera 800 - N. 2 cajones con 4 contenedores GN 1/1 15h de plástico, guías telescópicas.
cm. 79,5x 59x 47,5h



1.105,00
26 / 0,37

D-70
08470001

DIVISORIO BASE NEUTRA

EN Spacer for stand • **DE** Trennwand für offener unterbau • **FR** Separation pour placard ouvert • **ES** Divisorio para mueble base
cm. 5x 58x 38h

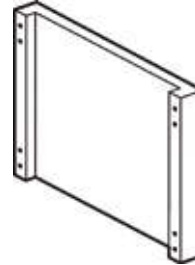

164,00
2.5 / 0,02

PT-74/94
08460002

PORTATEGLIE VANO 400/600 (GN-1/1) 4 RIPIANI INT. 7 CM.

EN Frame for plates 400/600 (GN-1/1) - N. 4 shelves, wheel-base 7 cm. • **DE** Aufangeschienen für bleche 400/600 (GN-1/1) N. 4 Etagen, Abstand 7 cm. • **FR** Kit porte-plaques 400/600 (GN-1/1) - N. 4 étagères; 7 cm. • **ES** Portacazuelas 400/600 (GN-1/1) - N. 4 estantes, int. 7 cm.

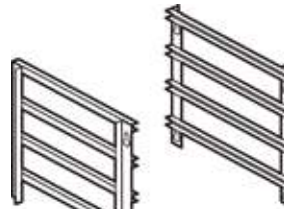

425,00
2.5 / 0,01

PT-78/98
08460012

PORTATEGLIE VANO 800 (GN-2/1) 4 RIPIANI INT. 7 CM.

EN Frame for plates 800 (GN-2/1) 4 Etagen, Abstand 7 cm. • **DE** Auflangeschienen für bleche 800 (GN-2/1) N. 4 Etagen, Abstand 7 cm. • **FR** Kit porte-plaques 800 (GN-2/1) - N. 4 étagères; 7 cm. • **ES** Portacazuelas 800 (GN-2/1) - N. 4 estantes, int. 7 cm.



568,00
4 / 0,01

531048800

CESTO 1/2 PER F13T-G/E

EN Basket 1/2 for F13T-G/E • **DE** Korb 1/2 zur Friteuse F13T-G/E • **FR** Panier 1/2 pour F13T-G/E • **ES** Cesta 1/2 para F13T-G/E
cm. 13,5x 29x 9h



91,00
0.8 / 0,03

531018800

CESTO 1/2 PER CPT-74 - 1/3 PER CPT-76

EN Basket 1/2 for CPT-74 - 1/3 for CPT-76 • **DE** Korb 1/2 für CPT-74 - 1/3 für CPT-76 • **FR** Panier 1/2 pour CPT-74 - 1/3 pour CPT-76 • **ES** Cesta 1/2 para CPT-74 - 1/3 para CPT-76
cm. 14,5x 29x 15h

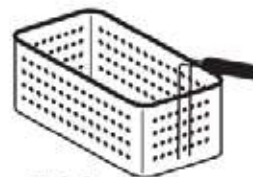

..188..

128,00
1,3 / 0,04

531053800

CESTO 1/4 PER CPT-76

EN Basket 1/4 for CPT-76 • **DE** Korb 1/4 für CPT-76 • **FR** Panier 1/4 pour CPT-76 • **ES** Cesta 1/4 para CPT-76
cm. 11,5x 29x 15h

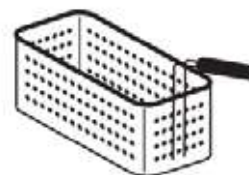

..538..

122,00
1,2 / 0,04

ACCESSORI CUOCIPASTA TOP

MOD. _____
COD. _____

DESCRIZIONE/DESCRIPTION/BEZEICHNUNG/DESCRIPTION/DESCRIPCIÓN
DIMENSIONI/DIMENSIONS/ABMESSUNGEN/DIMENSIONS/DIMENSIONES

POTENZA/POWER/LEISTUNG/PUISSANCE/POTENCIA
VOLTAGGIO/VOLTAGE/SPANNUNG/VOLTAGE/VOLTAJE

⚡ kW kcal/h
⚡ kw V~ Hz

PREZZO/PRICE
PREIS/PRIX/PRECIO
KG / M³



531040000 CESTO 1/1 PER CPT-76

EN Basket 1/1 for CPT-76 • **DE** Korb 1/1 für CPT-76 • **FR** Panier 1/1 pour CPT-76 • **ES** Cesta 1/1 para CPT-76
cm. 49x 29x 15h

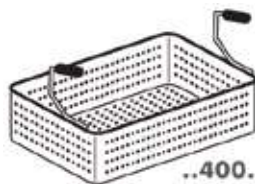

220,00
3,5 / 0,07

531048900 CESTO 1/6 PER CPT-74

EN Basket 1/6 for CPT-74 • **DE** Korb 1/6 für CPT-74 • **FR** Panier 1/6 pour CPT-74 • **ES** Cesta 1/6 para CPT-74
cm. 14x 10x 15h



80,00
1 / 0,01

531053700 CESTO 1/4 PER CPT-74

EN Basket 1/4 for CPT-74 • **DE** Korb 1/4 für CPT-74 • **FR** Panier 1/4 pour CPT-74 • **ES** Cesta 1/4 para CPT-74
cm. 14x 16x 15h

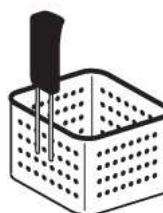

86,00
1 / 0,02

531053500 CESTO 1/1 PER CPT-74

EN Basket 1/1 for CPT-74 • **DE** Korb 1/1 für CPT-74 • **FR** Panier 1/1 pour CPT-74 • **ES** Cesta 1/1 para CPT-74
cm. 29x 29x 15h

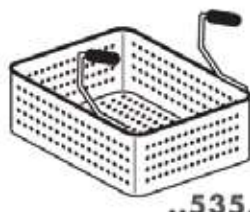

158,00
1,5 / 0,05

531071300 CESTO CON GANCIO 1/2 PER CPT-74 - 1/3 PER CPT-76

EN Basket with hook 1/2 for CPT-74 - 1/3 for CPT-76 • **DE** Korb mit Haken 1/2 für CPT-74 - 1/3 für CPT-76 • **FR** Panier avec crochet 1/2 pour CPT-74 - 1/3 pour CPT-76 • **ES** Cesta con gancho 1/2 para CPT-74 - 1/3 para CPT-76
cm. 13,5x 25,5x 15h



127,00
1,3 / 0,04

531071400 CESTO CON GANCIO 1/4 PER CPT-76

EN Basket with hook 1/4 for CPT-76 • **DE** Korb mit Haken 1/4 für CPT-76 • **FR** Panier avec crochet 1/4 pour CPT-76 • **ES** Cesta con gancho 1/4 para CPT-76
cm. 11x 25,5x 15h

120,00
1,2 / 0,03

531071800 GRIGLIA SUPPORTO CESTI CON GANCIO PER CPT-74

EN support for baskets with hook for CPT-74 • **DE** Unterstützung für Körbe mit Haken für CPT-74 • **FR** soutien pour les paniers avec crochet pour CPT-74 • **ES** soporte para cestas con gancho para CPT-74
cm. 30x 33x 25h



128,00
3 / 0,04

ACCESSORI CUOCIPASTA TOP

MOD. _____
COD. _____

DESCRIZIONE/DESCRIPTION/BEZEICHNUNG/DESCRIPTION/DESCRIPCIÓN
DIMENSIONI/DIMENSIONS/ABMESSUNGEN/DIMENSIONS/DIMENSIONES

POTENZA/POWER/LEISTUNG/PUISSANCE/POTENCIA
VOLTAGGIO/VOLTAGE/SPANNUNG/VOLTAGE/VOLTAJE

$\frac{kW}{kcal/h}$ $\frac{kW}{V \sim}$
 $\frac{Hz}{}$

PREZZO/PRICE €
PREIS/PRIX/PRECIO €
KG / M³

531071900 GRIGLIA SUPPORTO CESTI CON GANCIO PER CPT-76

EN support for baskets with hook for CPT-76 • **DE** Unterstützung für Körbe mit Haken für CPT-76 • **FR** soutien pour les paniers avec crochet pour CPT-76 • **ES** soporte para cestas con gancho para CPT-76
cm. 50x 30x 25h



166,00
3,5 / 0,06



CUCINE ELETTRICHE

MOD. _____
COD. _____

DESCRIZIONE / DESCRIPTION / BEZEICHNUNG / DESCRIPTION / DESCRIPCIÓN
DIMENSIONI / DIMENSIONS / ABMESSUNGEN / DIMENSIONS / DIMENSIONES

POTENZA / POWER / LEISTUNG / PUISSANCE / POTENCIA
VOLTAGGIO / VOLTAGE / SPANNUNG / VOLTAGE / VOLTAJE

⚡ $\frac{\text{kW}}{\text{kcal/h}}$ $\frac{\text{kW}}{\text{V-}}$
Hz

PREZZO / PRICE
PREIS / PRIX / PRECIO
KG / M³



CF4-98ET
09660830

CUCINA 4 PIASTRE - FORNO ELETTRICO STATICO CM. 67X73X34H, TEMP: 50÷300°C, CON 1 GRIGLIA CM.65X71 GN2/1 (INCLUSA 1 TESTATA CHIUSURA PIANO MOD.TPA-9)
EN Electric range - N. 4 plates Traditional electric oven cm. 67x73x34h, temp: 50÷300°C, with 1 grid cm.65x71 GN2/1 (included 1 Head end filler strip mod.TPA-9) • **DE** Elektroherd - N. 4 Kochplatten Statischer Elektro-Backofen cm. 67x73x34h, temp: 50÷300°C, mit 1 Rost cm.65x71 GN2/1 (inbegriffen 1 Abschluss-Element mod.TPA-9) • **FR** Fourneau électrique - N. 4 plaques Four électrique statique cm. 67x73x34h, temp: 50÷300°C, avec 1 grille cm.65x71 GN2/1 (inclus 1 Élément de jonction top mod.TPA-9) • **ES** Cocina eléctrica - N. 4 planchas Horno eléctrico estático cm. 67x73x34h, temp: 50÷300°C, con 1 parilla cm.65x71 GN2/1 (incluida 1 Chapa de cierre para top mod.TPA-9)
cm. 80x 90x 90h



⚡ $\frac{20,7 \text{ kW}}{400\text{V}\sim 3\text{N}}$ **5.137,00**
50/60 Hz 142 / 0,89

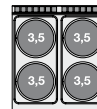

CFV4-98ET
09660835

CUCINA 4 PIASTRE - FORNO ELETTRICO VENTILATO CM. 55X36X34H, TEMP: 50÷300°C, CON 1 GRIGLIA CM.53X32,5 GN1/1 (INCLUSA 1 TESTATA CHIUSURA PIANO MOD.TPA-9)
EN Electric range - N. 4 plates - electric fan oven cm. 55x36x34h, temp: 50÷300°C, with 1 grid cm.53x32,5 GN1/1 (included 1 Head end filler strip mod.TPA-9) • **DE** Elektroherd - N. 4 Kochplatten - Elektro-Heißluftofen cm. 55x36x34h, temp: 50÷300°C, mit 1 Rost cm.53x32,5 GN1/1 (inbegriffen 1 Abschluss-Element mod.TPA-9) • **FR** Fourneau électrique - N. 4 plaques Four à chaleur tournante électrique cm. 55x36x34h, temp: 50÷300°C, avec 1 grille cm.53x32,5 GN1/1 (inclus 1 Élément de jonction top mod.TPA-9) • **ES** Cocina eléctrica - N. 4 planchas - Horno eléctrico ventilado cm. 55x36x34h, temp: 50÷300°C, con 1 parilla cm.53x32,5 GN1/1 (incluida 1 Chapa de cierre para top mod.TPA-9)
cm. 80x 90x 90h

⚡ $\frac{19,32 \text{ kW}}{400\text{V}\sim 3\text{N}}$ **5.578,00**
50/60 Hz 142 / 0,89

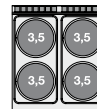

CFQ4-98ET
09660831

CUCINA 4 PIASTRE QUADRE - FORNO ELETTRICO STATICO CM. 67X73X34H, TEMP: 50÷300°C, CON 1 GRIGLIA CM.65X71 GN2/1 (INCLUSA 1 TESTATA CHIUSURA PIANO MOD.TPA-9)
EN Electric range - N. 4 square plates Traditional electric oven cm. 67x73x34h, temp: 50÷300°C, with 1 grid cm.65x71 GN2/1 (included 1 Head end filler strip mod.TPA-9) • **DE** Elektroherd - N. 4 quadratischen Platten - Statischer Elektro-Backofen cm. 67x73x34h, temp: 50÷300°C, mit 1 Rost cm.65x71 GN2/1 (inbegriffen 1 Abschluss-Element mod.TPA-9) • **FR** Fourneau électrique - N. 4 plaques carrés - Four électrique statique cm. 67x73x34h, temp: 50÷300°C, avec 1 grille cm.65x71 GN2/1 (inclus 1 Élément de jonction top mod.TPA-9) • **ES** Cocina eléctrica - N. 4 planchas cuadradas Horno eléctrico estático cm. 67x73x34h, temp: 50÷300°C, con 1 parilla cm.65x71 GN2/1 (incluida 1 Chapa de cierre para top mod.TPA-9)
cm. 80x 90x 90h



⚡ $\frac{22,7 \text{ kW}}{400\text{V}\sim 3\text{N}}$ **6.209,00**
50/60 Hz 150 / 0,89



CFVQ4-98ET
09660836

CUCINA 4 PIASTRE QUADRE - FORNO ELETTRICO VENTILATO CM. 55X36X34H, TEMP: 50÷300°C, CON 1 GRIGLIA CM.53X32,5 GN1/1 (INCLUSA 1 TESTATA CHIUSURA PIANO MOD.TPA-9)
EN Electric range - N. 4 square plates - electric fan oven cm. 55x36x34h, temp: 50÷300°C, with 1 grid cm.53x32,5 GN1/1 (included 1 Head end filler strip mod.TPA-9) • **DE** Elektroherd - N. 4 quadratischen Platten - Elektro-Heißluftofen cm. 55x36x34h, temp: 50÷300°C, mit 1 Rost cm.53x32,5 GN1/1 (inbegriffen 1 Abschluss-Element mod.TPA-9) • **FR** Fourneau électrique - N. 4 plaques carrés - Four à chaleur tournante électrique cm. 55x36x34h, temp: 50÷300°C, avec 1 grille cm.53x32,5 GN1/1 (inclus 1 Élément de jonction top mod.TPA-9) • **ES** Cocina eléctrica - N. 4 planchas cuadradas Horno eléctrico ventilado cm. 55x36x34h, temp: 50÷300°C, con 1 parilla cm.53x32,5 GN1/1 (incluida 1 Chapa de cierre para top mod.TPA-9)
cm. 80x 90x 90h

⚡ $\frac{21,32 \text{ kW}}{400\text{V}\sim 3\text{N}}$ **6.650,00**
50/60 Hz 150 / 0,89



MOD. _____
COD. _____

DESCRIZIONE/DESCRIPTION/BEZEICHNUNG/DESCRIPTION/DESCRIPCIÓN
DIMENSIONI/DIMENSIONS/ABMESSUNGEN/DIMENSIONS/DIMENSIONES

POTENZA/POWER/LEISTUNG/PUISSANCE/POTENCIA
VOLTAGGIO/VOLTAGE/SPANNUNG/VOLTAGE/VOLTAJE

⚡ kW kcal/h
⚡ kw V~ Hz

PREZZO/PRICE
PREIS/PRIX/PRECIO
KG / M³



CFC4-98ET
09660832

CUCINA 4 PIASTRE VETROCERAMICA CM. 75 X 75 - FORNO ELETTRICO STATICO CM. 67X73X34H, TEMP: 50÷300°C, CON 1 GRIGLIA CM.65X71 GN2/1 (INCLUSA 1 TESTATA CHIUSURA PIANO MOD.TPA-9)

EN Electric range N. 4 plates ceramic glass cm. 75 x 75 - traditional electric oven cm. 67x73x34h, temp: 50÷300°C, with 1 grid cm.65x71 GN2/1 (included 1 Head end filler strip mod.TPA-9) • **DE** Elektroherd N. 4 Ceran-Kochplatten cm. 75 x 75 - Statischer Elektro-Backofen cm. 67x73x34h, temp: 50÷300°C, mit 1 Rost cm.65x71 GN2/1 (inbegriffen 1 Abschluss-Element mod.TPA-9) • **FR** Fourneau électrique N. 4 plaques vitroceramique cm. 75 x 75 - Four électrique statique cm. 67x73x34h, temp: 50÷300°C, avec 1 grille cm.65x71 GN2/1 (inclus 1 Élément de jonction top mod.TPA-9) • **ES** Cocina eléctrica N. 4 planchas vitrocerámica cm. 75 x 75 - Horno eléctrico estático cm. 67x73x34h, temp: 50÷300°C, con 1 parilla cm.65x71 GN2/1 (incluida 1 Chapa de cierre para top mod.TPA-9)
cm. 80x 90x 90h



⚡ 20,3 kW
400V~3N
50/60 Hz

6.864,00
130 / 0,89

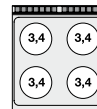

CFVC4-98ET
09660837

CUCINA 4 PIASTRE VETROCERAMICA CM. 75 X 75 - FORNO ELETTRICO VENTILATO CM. 55X36X34H, TEMP: 50÷300°C, CON 1 GRIGLIA CM.53X32,5 GN1/1 (INCLUSA 1 TESTATA CHIUSURA PIANO MOD.TPA-9)

EN Electric range N. 4 plates ceramic glass cm. 75 x 75 - electric fan oven cm. 55x36x34h, temp: 50÷300°C, with 1 grid cm.53x32,5 GN1/1 (included 1 Head end filler strip mod.TPA-9) • **DE** Elektroherd N. 4 Ceran-Kochplatten cm. 75 x 75 - Elektro-Heißluftofen cm. 55x36x34h, temp: 50÷300°C, mit 1 Rost cm.53x32,5 GN1/1 (inbegriffen 1 Abschluss-Element mod.TPA-9) • **FR** Fourneau électrique N. 4 plaques vitroceramique cm. 75 x 75 - Four à chaleur tournante électrique cm. 55x36x34h, temp: 50÷300°C, avec 1 grille cm.53x32,5 GN1/1 (inclus 1 Élément de jonction top mod.TPA-9) • **ES** Cocina eléctrica N. 4 planchas vitrocerámica cm. 75 x 75 - Horno eléctrico ventilado cm. 55x36x34h, temp: 50÷300°C, con 1 parilla cm.53x32,5 GN1/1 (incluida 1 Chapa de cierre para top mod.TPA-9)
cm. 80x 90x 90h

⚡ 18,92 kW
400V~3N
50/60 Hz

7.305,00
130 / 0,89

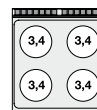

CF4-98G
09680850

CUCINA 4 FUOCHI - FORNO A GAS STATICO CM. 67X73X34H, TEMP: 150÷300°C, CON 1 GRIGLIA CM.65X71 GN2/1 (INCLUSA 1 TESTATA CHIUSURA PIANO MOD.TPC-9)

EN Gas Range - N. 4 burners Traditional gas-oven cm. 67x73x34h, temp: 150÷300°C, with 1 grid cm.65x71 GN2/1 (included 1 Head end filler strip mod.TPC-9) • **DE** Gasherd - N. 4 Kochstellen Statischer Gas-Backofen cm. 67x73x34h, temp: 150÷300°C, mit 1 Rost cm.65x71 GN2/1 (inbegriffen 1 Abschluss-Element mod.TPC-9) • **FR** Cuisiniere gaz - N. 4 feux vifs Four à gaz statique cm. 67x73x34h, temp: 150÷300°C, avec 1 grille cm.65x71 GN2/1 (inclus 1 Élément de jonction top mod.TPC-9) • **ES** Cocina a gas - N. 4 quemadores Horno a gas estático cm. 67x73x34h, temp: 150÷300°C, con 1 parilla cm.65x71 GN2/1 (incluida 1 Chapa de cierre para top mod.TPC-9)
cm. 80x 90x 90h



⚡ 36,5 kW
31.390 kcal/h

4.753,00
166 / 0,89

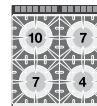

CF4-98GE
09690860

CUCINA 4 FUOCHI - FORNO ELETTRICO STATICO CM. 67X73X34H, TEMP: 50÷300°C, CON 1 GRIGLIA CM.65X71 GN2/1 (INCLUSA 1 TESTATA CHIUSURA PIANO MOD.TPC-9)

EN Gas Range - N. 4 burners - traditional electric oven cm. 67x73x34h, temp: 50÷300°C, with 1 grid cm.65x71 GN2/1 (included 1 Head end filler strip mod.TPC-9) • **DE** Gasherd - N. 4 Kochstellen Statischer Elektro-Backofen cm. 67x73x34h, temp: 50÷300°C, mit 1 Rost cm.65x71 GN2/1 (inbegriffen 1 Abschluss-Element mod.TPC-9) • **FR** Cuisiniere gaz - N. 4 feux vifs Four électrique statique cm. 67x73x34h, temp: 50÷300°C, avec 1 grille cm.65x71 GN2/1 (inclus 1 Élément de jonction top mod.TPC-9) • **ES** Cocina a gas - N. 4 quemadores Horno eléctrico estático cm. 67x73x34h, temp: 50÷300°C, con 1 parilla cm.65x71 GN2/1 (incluida 1 Chapa de cierre para top mod.TPC-9)
cm. 80x 90x 90h



⚡ 28 kW
24.080 kcal/h

4.848,00
164 / 0,89

⚡ 6,7 kW
400V~3N
50/60 Hz

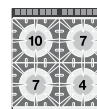

CUCINE A GAS CON FORNO ELETTRICO

MOD. _____
COD. _____

DESCRIZIONE/DESCRIPTION/BEZEICHNUNG/DESCRIPTION/DESCRIPCIÓN
DIMENSIONI/DIMENSIONS/ABMESSUNGEN/DIMENSIONS/DIMENSIONES

POTENZA/POWER/LEISTUNG/PUISSANCE/POTENCIA
VOLTAGGIO/VOLTAGE/SPANNUNG/VOLTAGE/VOLTAJE

⚡ kW
kcal/h

PREZZO/PRICE
PREIS/PRIX/PRECIO
KG / M³



CFV4-98GE
09690865

CUCINA 4 FUOCHI - FORNO ELETTRICO VENTILATO CM. 55X36X34H, TEMP: 50÷300°C, CON 1 GRIGLIA CM.53X32,5 GN1/1 (INCLUSA 1 TESTATA CHIUSURA PIANO MOD.TPC-9)
EN Gas Range - N. 4 burners - electric fan oven cm. 55x36x34h, temp: 50÷300°C, with 1 grid cm.53x32,5 GN1/1 (included 1 Head end filler strip mod.TPC-9) • **DE** Gasherd - N. 4 Kochstellen Elektro-Heißluftofen cm. 55x36x34h, temp: 50÷300°C, mit 1 Rost cm.53x32,5 GN1/1 (inbegriffen 1 Abschluss-Element mod.TPC-9) • **FR** Cuisiniere gaz - N. 4 feux vifs Four à chaleur tournante électrique cm. 55x36x34h, temp: 50÷300°C, avec 1 grille cm.53x32,5 GN1/1 (inclus 1 Élément de jonction top mod.TPC-9) • **ES** Cocina a gas - N. 4 quemadores Horno eléctrico ventilado cm. 55x36x34h, temp: 50÷300°C, con 1 parilla cm.53x32,5 GN1/1 (incluida 1 Chapa de cierre para top mod.TPC-9)
cm. 80x 90x 90h



⚡ 28 kW
24.080 kcal/h

5.282,00
164 / 0,89

⚡ 5,32 kW
400V~3N
230V~3
50/60 Hz

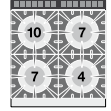

CFA4-98G
09750850

CUCINA ACQUA 4 FUOCHI - FORNO A GAS STATICO CM. 67X73X34H, TEMP: 150÷300°C, CON 1 GRIGLIA CM.65X71 GN2/1 - RUBINETTO CARICO ACQUA, SFIORATORE (INCLUSA 1 TESTATA CHIUSURA PIANO MOD.TPA-9)
EN Water range - N. 4 burners Traditional gas-oven cm. 67x73x34h, temp: 150÷300°C, with 1 grid cm.65x71 GN2/1 - Water loading tap + overflow device (included 1 Head end filler strip mod.TPA-9) • **DE** Wasser herd - N. 4 Kochstellen Statischer Gas-Backofen cm. 67x73x34h, temp: 150÷300°C, mit 1 Rost cm.65x71 GN2/1 - Wasserlauf-Hahn + Überlauf-Vorrichtung (inbegriffen 1 Abschluss-Element mod.TPA-9) • **FR** Cuisinière l'eau - N. 4 feux vifs Four à gaz statique cm. 67x73x34h, temp: 150÷300°C, avec 1 grille cm.65x71 GN2/1 - Robinet d'arrivée d'eau trop plein (inclus 1 Élément de jonction top mod.TPA-9) • **ES** Cocina a agua - N. 4 quemadores Horno a gas estático cm. 67x73x34h, temp: 150÷300°C, con 1 parilla cm.65x71 GN2/1 - Grifo carga agua + vertedero (incluida 1 Chapa de cierre para top mod.TPA-9)
cm. 80x 90x 90h



⚡ 36,5 kW
31.390 kcal/h

6.243,00
166 / 0,89



CF6-912ETV
09661230

CUCINA 6 PIASTRE - FORNO ELETTRICO STATICO CM. 67X73X34H, TEMP: 50÷300°C, CON 1 GRIGLIA CM.65X71 GN2/1 - VANO NEUTRO CON PORTA (INCLUSA 1 TESTATA CHIUSURA PIANO MOD.TPA-9)
EN Electric range - N. 6 plates Traditional electric oven cm. 67x73x34h, temp: 50÷300°C, with 1 grid cm.65x71 GN2/1 - Neutral cabinet with door (included 1 Head end filler strip mod.TPA-9) • **DE** Elektroherd - N. 6 Kochplatten Statischer Elektro-Backofen cm. 67x73x34h, temp: 50÷300°C, mit 1 Rost cm.65x71 GN2/1 - Neutrales Schrankelement mit Tür (inbegriffen 1 Abschluss-Element mod.TPA-9) • **FR** Fourneau électrique - N. 6 plaques Four électrique statique cm. 67x73x34h, temp: 50÷300°C, avec 1 grille cm.65x71 GN2/1 - Element neutre avec porte (inclus 1 Élément de jonction top mod.TPA-9) • **ES** Cocina eléctrica - N. 6 planchas Horno eléctrico estático cm. 67x73x34h, temp: 50÷300°C, con 1 parilla cm.65x71 GN2/1 - Armario neutro con puerta (incluida 1 Chapa de cierre para top mod.TPA-9)
cm. 120x 90x 90h



⚡ 27,7 kW
400V~3N
50/60 Hz

6.765,00
200 / 1,32



CFV6-912ETV
09661235

CUCINA 6 PIASTRE - FORNO ELETTRICO VENTILATO CM. 55X36X34H, TEMP: 50÷300°C, CON 1 GRIGLIA CM.53X32,5 GN1/1 - VANO NEUTRO CON PORTA (INCLUSA 1 TESTATA CHIUSURA PIANO MOD.TPA-9)
EN Electric range - N. 6 plates electric fan oven cm. 55x36x34h, temp: 50÷300°C, with 1 grid cm.53x32,5 GN1/1 - Neutral cabinet with door (included 1 Head end filler strip mod.TPA-9) • **DE** Elektroherd - N. 6 Kochplatten Elektro-Heißluftofen cm. 55x36x34h, temp: 50÷300°C, mit 1 Rost cm.53x32,5 GN1/1 - Neutrales Schrankelement mit Tür (inbegriffen 1 Abschluss-Element mod.TPA-9) • **FR** Fourneau électrique - N. 6 plaques Four à chaleur tournante électrique cm. 55x36x34h, temp: 50÷300°C, avec 1 grille cm.53x32,5 GN1/1 - Element neutre avec porte (inclus 1 Élément de jonction top mod.TPA-9) • **ES** Cocina eléctrica - N. 6 planchas Horno eléctrico ventilado cm. 55x36x34h, temp: 50÷300°C, con 1 parilla cm.53x32,5 GN1/1 - Armario neutro con puerta (incluida 1 Chapa de cierre para top mod.TPA-9)
cm. 120x 90x 90h

⚡ 26,32 kW
400V~3N
50/60 Hz

7.206,00
200 / 1,32



MOD. _____
COD. _____

DESCRIZIONE/DESCRIPTION/BEZEICHNUNG/DESCRIPTION/DESCRIPCIÓN
DIMENSIONI/DIMENSIONS/ABMESSUNGEN/DIMENSIONS/DIMENSIONES

POTENZA/POWER/LEISTUNG/PUISSANCE/POTENCIA
VOLTAGGIO/VOLTAGE/SPANNUNG/VOLTAGE/VOLTAJE

⚡ kW _____
kcal/h _____
V~ _____
Hz _____

PREZZO/PRICE
PREIS/PRIX/PRECIO
KG / M³



CFQ6-912ET CUCINA 6 PIASTRE QUADRE - FORNO ELETTRICO STATICO
09661231 **CM. 67X73X34H, TEMP: 50÷300°C, CON 1 GRIGLIA**
CM.65X71 GN2/1 - VANO NEUTRO CON PORTA (INCLUSA 1
TESTATA CHIUSURA PIANO MOD.TPA-9)

EN Electric range - N. 6 square plates Traditional electric oven cm. 67x73x34h, temp: 50÷300°C, with 1 grid cm.65x71 GN2/1 - Neutral cabinet with door (included 1 Head end filler strip mod.TPA-9) • **DE** Elektroherd - N. 6 quadratischen Platten Statischer Elektro-Backofen cm. 67x73x34h, temp: 50÷300°C, mit 1 Rost cm.65x71 GN2/1 - Neutrales Schrankelement mit Tür (inbegriffen 1 Abschluss-Element mod.TPA-9) • **FR** Fourneau électrique - N. 6 plaques carrés Four électrique statique cm. 67x73x34h, temp: 50÷300°C, avec 1 grille cm.65x71 GN2/1 - Element neutre avec porte (inclus 1 Élément de jonction top mod.TPA-9) • **ES** Cocina eléctrica - N. 6 planchas cuadradas Horno eléctrico estático cm. 67x73x34h, temp: 50÷300°C, con 1 parilla cm.65x71 GN2/1 - Armario neutro con puerta (incluida 1 Chapa de cierre para top mod. TPA-9)
cm. 120x 90x 90h



⚡ 30,7 kW _____ **8.553,00**
400V~3N _____ 212 / 1,32
50/60 Hz

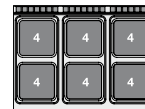

CFVQ6-912ET CUCINA 6 PIASTRE QUADRE - FORNO ELETTRICO VENTILATO
09661236 **CM. 55X36X34H, TEMP: 50÷300°C, CON 1 GRIGLIA**
CM.53X32,5 GN1/1 - VANO NEUTRO CON PORTA (INCLUSA
1 TESTATA CHIUSURA PIANO MOD.TPA-9)

EN Electric range - N. 6 square plates electric fan oven cm. 55x36x34h, temp: 50÷300°C, with 1 grid cm.53x32,5 GN1/1 - Neutral cabinet with door (included 1 Head end filler strip mod.TPA-9) • **DE** Elektroherd - N. 6 quadratischen Platten Elektro-Heißluftofen cm. 55x36x34h, temp: 50÷300°C, mit 1 Rost cm.53x32,5 GN1/1 - Neutrales Schrankelement mit Tür (inbegriffen 1 Abschluss-Element mod.TPA-9) • **FR** Fourneau électrique - N. 6 plaques carrés Four à chaleur tournante électrique cm. 55x36x34h, temp: 50÷300°C, avec 1 grille cm.53x32,5 GN1/1 - Element neutre avec porte (inclus 1 Élément de jonction top mod.TPA-9) • **ES** Cocina eléctrica - N. 6 planchas cuadradas Horno eléctrico ventilado cm. 55x36x34h, temp: 50÷300°C, con 1 parilla cm.53x32,5 GN1/1 - Armario neutro con puerta (incluida 1 Chapa de cierre para top mod.TPA-9)
cm. 120x 90x 90h

⚡ 29,32 kW _____ **8.994,00**
400V~3N _____ 212 / 1,32
50/60 Hz

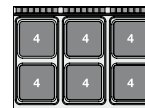

CF6-912ET CUCINA 6 PIASTRE FORNO ELETTRICO STATICO CM.
09661232 **107X73X34H, TEMP: 50÷300°C, CON 1 GRIGLIA**
CM.105X71 (INCLUSA 1 TESTATA CHIUSURA PIANO MOD.
TPA-9)

EN Electric Range - N. 6 plates Traditional electric oven cm. 107x73x34h, temp: 50÷300°C, with 1 grid cm.105x71 (included 1 Head end filler strip mod.TPA-9) • **DE** Elektroherd - N. 6 Kochplatten Statischer Elektro-Backofen cm. 107x73x34h, temp: 50÷300°C, mit 1 Rost cm.105x71 (inbegriffen 1 Abschluss-Element mod.TPA-9) • **FR** Fourneau électrique - N. 6 plaques Four électrique statique cm. 107x73x34h, temp: 50÷300°C, avec 1 grille cm.105x71 (inclus 1 Élément de jonction top mod.TPA-9) • **ES** Cocina eléctrica - N. 6 planchas Horno eléctrico estático cm. 107x73x34h, temp: 50÷300°C, con 1 parilla cm.105x71 (incluida 1 Chapa de cierre para top mod.TPA-9)
cm. 120x 90x 90h



⚡ 30,2 kW _____ **7.331,00**
400V~3N _____ 206 / 1,32
50/60 Hz

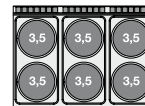

CFQ6-912ET CUCINA 6 PIASTRE QUADRE FORNO ELETTRICO STATICO
09661233 **CM. 107X73X34H, TEMP: 50÷300°C, CON 1 GRIGLIA**
CM.105X71 (INCLUSA 1 TESTATA CHIUSURA PIANO MOD.
TPA-9)

EN Electric Range - N. 6 square plates Traditional electric oven cm. 107x73x34h, temp: 50÷300°C, with 1 grid cm.105x71 (included 1 Head end filler strip mod.TPA-9) • **DE** Elektroherd - N. 6 quadratischen Platten Statischer Elektro-Backofen cm. 107x73x34h, temp: 50÷300°C, mit 1 Rost cm.105x71 (inbegriffen 1 Abschluss-Element mod.TPA-9) • **FR** Fourneau électrique - N. 6 plaques carrés Four électrique statique cm. 107x73x34h, temp: 50÷300°C, avec 1 grille cm.105x71 (inclus 1 Élément de jonction top mod.TPA-9) • **ES** Cocina eléctrica - N. 6 planchas cuadradas Horno eléctrico estático cm. 107x73x34h, temp: 50÷300°C, con 1 parilla cm.105x71 (incluida 1 Chapa de cierre para top mod.TPA-9)
cm. 120x 90x 90h



⚡ 33,2 kW _____ **9.112,00**
400V~3N _____ 218 / 1,32
50/60 Hz

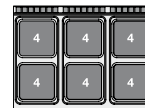

MOD. _____
COD. _____

DESCRIZIONE/DESCRIPTION/BEZEICHNUNG/DESCRIPTION/DESCRIPCIÓN
DIMENSIONI/DIMENSIONS/ABMESSUNGEN/DIMENSIONS/DIMENSIONES

POTENZA/POWER/LEISTUNG/PUISSANCE/POTENCIA
VOLTAGGIO/VOLTAGE/SPANNUNG/VOLTAGE/VOLTAJE

⚡ kW _____
kcal/h _____
V~ _____
Hz _____

PREZZO/PRICE
PREIS/PRIX/PRECIO
KG / M³



CF6-912GV CUCINA 6 FUOCHI FORNO A GAS STATICO CM. 67X73X34H, TEMP: 150÷300°C, CON 1 GRIGLIA CM.65X71 GN2/1 - VANO NEUTRO CON PORTA (INCLUSA 1 TESTATA CHIUSURA PIANO MOD.TPC-9)

09681251

EN Gas Range - N. 6 burners Traditional gas-oven GN cm. 67x73x34h, temp: 150÷300°C, with 1 grid cm.65x71 GN2/1 - Neutral cabinet with door (included 1 Head end filler strip mod.TPC-9) • **DE** Gasherd - N. 6 Kochstellen - Statischer Gas-Backofen cm. 67x73x34h, temp: 150÷300°C, mit 1 Rost cm.65x71 GN2/1 - Neutrales Schrankelement mit Tür (inbegriffen 1 Abschluss-Element mod.TPC-9) • **FR** Cuisiniere Gaz - N. 6 feux vifs Four à gaz statique cm. 67x73x34h, temp: 150÷300°C, avec 1 grille cm.65x71 GN2/1 - Élément neutre avec porte (inclus 1 Élément de jonction top mod.TPC-9) • **ES** Cocina a gas - N. 6 quemadores Horno a gas estático cm. 67x73x34h, temp: 150÷300°C, con 1 parilla cm.65x71 GN2/1 - Armario neutro con puerta (incluida 1 Chapa de cierre para top mod.TPC-9)
cm. 120x 90x 90h



⚡ 53,5 kW _____
46.010 kcal/h _____ **6.440,00**
230 / 1,32

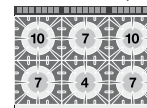

CF6-912GEV CUCINA 6 FUOCHI - FORNO ELETTRICO STATICO CM. 67X73X34H, TEMP: 50÷300°C, CON 1 GRIGLIA CM.65X71 GN2/1 - VANO NEUTRO CON PORTA (INCLUSA 1 TESTATA CHIUSURA PIANO MOD.TPC-9)

09691261

EN Gas Range - N. 6 burners - tradiional elettric oven cm. 67x73x34h, temp: 50÷300°C, with 1 grid cm.65x71 GN2/1 - Neutral cabinet with door (included 1 Head end filler strip mod.TPC-9) • **DE** Gasherd - N. 6 Kochstellen Statischer Elektro-Backofen cm. 67x73x34h, temp: 50÷300°C, mit 1 Rost cm.65x71 GN2/1 - Neutrales Schrankelement mit Tür (inbegriffen 1 Abschluss-Element mod.TPC-9) • **FR** Cuisiniere gaz - N. 6 feux vifs Four électrique statique cm. 67x73x34h, temp: 50÷300°C, avec 1 grille cm.65x71 GN2/1 - Element neutre avec porte (inclus 1 Élément de jonction top mod.TPC-9) • **ES** Cocina a gas - N. 6 quemadores Horno eléctrico estático cm. 67x73x34h, temp: 50÷300°C, con 1 parilla cm.65x71 GN2/1 - Armario neutro con puerta (incluida 1 Chapa de cierre para top mod.TPC-9)
cm. 120x 90x 90h



⚡ 45 kW _____
38.700 kcal/h _____ **6.556,00**
228 / 1,32

⚡ 6,7 kW _____
400V~3N
50/60 Hz

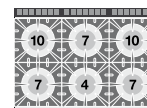

CFV6-912GEV CUCINA 6 FUOCHI - FORNO ELETTRICO VENTILATO CM. 55X36X34H, TEMP: 50÷300°C, CON 1 GRIGLIA CM.53X32,5 GN1/1 - VANO NEUTRO CON PORTA (INCLUSA 1 TESTATA CHIUSURA PIANO MOD.TPC-9)

09691266

EN Gas Range - N. 6 burners - electric fan oven cm. 55x36x34h, temp: 50÷300°C, with 1 grid cm.53x32,5 GN1/1 - Neutral cabinet with door (included 1 Head end filler strip mod.TPC-9) • **DE** Gas Range - N. 6 burners - electric fan oven cm. 55x36x34h, temp: 50÷300°C, mit 1 Rost cm.53x32,5 GN1/1 - Neutral cabinet with door (inbegriffen 1 Abschluss-Element mod.TPC-9) • **FR** Gas Range - N. 6 burners - electric fan oven cm. 55x36x34h, temp: 50÷300°C, avec 1 grille cm.53x32,5 GN1/1 - Neutral cabinet with door (inclus 1 Élément de jonction top mod.TPC-9) • **ES** Gas Range - N. 6 burners - electric fan oven cm. 55x36x34h, temp: 50÷300°C, con 1 parilla cm.53x32,5 GN1/1 - Neutral cabinet with door (incluida 1 Chapa de cierre para top mod.TPC-9)
cm. 120x 90x 90h

⚡ 45 kW _____
38.700 kcal/h _____ **6.997,00**
228 / 1,32

⚡ 5,32 kW _____
400V~3N
230V~3
50/60 Hz

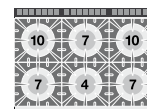

CFA6-912GV CUCINA ACQUA 6 FUOCHI - FORNO A GAS STATICO CM. 67X73X34H, TEMP: 150÷300°C, CON 1 GRIGLIA CM.65X71 GN2/1 - VANO NEUTRO CON PORTA - RUBINETTO CARICO ACQUA, SFIORATORE (INCLUSA 1 TESTATA CHIUSURA PIANO MOD.TPA-9)

09751251

EN Water range - N. 6 burners - Traditional gas-oven cm. 67x73x34h, temp: 150÷300°C, with 1 grid cm.65x71 GN2/1 - Neutral cabinet with door - Water loading tap + overflow device (included 1 Head end filler strip mod.TPA-9) • **DE** Wasser herd - N. 6 Kochstellen - Statischer Gas-Backofen cm. 67x73x34h, temp: 150÷300°C, mit 1 Rost cm.65x71 GN2/1 - Neutrales Schrankelement mit Tür - Wasserlauf-Hahn + Überlauf-Vorrichtung (inbegriffen 1 Abschluss-Element mod.TPA-9) • **FR** Cuisiniere l'eau - N. 6 feux vifs Four à gaz statique cm. 67x73x34h, temp: 150÷300°C, avec 1 grille cm.65x71 GN2/1 - Element neutre avec porte - Robinet d'arrivée d'eau trop plein (inclus 1 Élément de jonction top mod.TPA-9) • **ES** Cocina a agua N. 6 quemadores Horno a gas estático cm. 67x73x34h, temp: 150÷300°C, con 1 parilla cm.65x71 GN2/1 - Armario neutro con puerta - Grifo carga agua + vertedero (incluida 1 Chapa de cierre para top mod.TPA-9)
cm. 120x 90x 90h



⚡ 50,5 kW _____
43.430 kcal/h _____ **8.148,00**
230 / 1,32

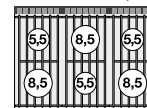

MOD. _____
COD. _____

DESCRIZIONE/DESCRIPTION/BEZEICHNUNG/DESCRIPTION/DESCRIPCIÓN
DIMENSIONI/DIMENSIONS/ABMESSUNGEN/DIMENSIONS/DIMENSIONES

POTENZA/POWER/LEISTUNG/PUISSANCE/POTENCIA
VOLTAGGIO/VOLTAGE/SPANNUNG/VOLTAGE/VOLTAJE

⚡ kW
kcal/h

PREZZO/PRICE
PREIS/PRIX/PRECIO
KG / M³



CF6-912G
09681250

CUCINA 6 FUOCHI FORNO A GAS STATICO CM. 107X73X34H, TEMP: 150÷300°C, CON 1 GRIGLIA CM.105X71 (INCLUSA 1 TESTATA CHIUSURA PIANO MOD. TPC-9)

EN Gas Range - N. 6 burners Traditional gas-oven cm. 107x73x34h, temp: 150÷300°C, with 1 grid cm.105x71 (included 1 Head end filler strip mod.TPC-9) • **DE** Gasherd - N. 6 Kochstellen Statischer Gas-Backofen cm. 107x73x34h, temp: 150÷300°C, mit 1 Rost cm.105x71 (inbegriffen 1 Abschluss-Element mod.TPC-9) • **FR** Cuisiniere gaz - N. 6 feux vifs Four à gaz statique cm. 107x73x34h, temp: 150÷300°C, avec 1 grille cm.105x71 (inclus 1 Élément de jonction top mod.TPC-9) • **ES** Cocina a gas - N. 6 quemadores Horno a gas estático cm. 107x73x34h, temp: 150÷300°C, con 1 parilla cm.105x71 (incluida 1 Chapa de cierre para top mod.TPC-9)
cm. 120x 90x 90h



⚡ 58 kW
49.820 kcal/h

6.926,00
236 / 1,32

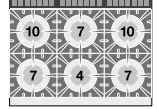

CF6-912GE
09691260

CUCINA 6 FUOCHI FORNO ELETTRICO STATICO CM. 107X73X34H, TEMP: 50÷300°C, CON 1 GRIGLIA CM.105X71 (INCLUSA 1 TESTATA CHIUSURA PIANO MOD. TPC-9)

EN Gas Range - N. 6 burners Traditional electric oven cm. 107x73x34h, temp: 50÷300°C, with 1 grid cm.105x71 (included 1 Head end filler strip mod.TPC-9) • **DE** Gasherd - N. 6 Kochstellen Statischer Elektro-Backofen cm. 107x73x34h, temp: 50÷300°C, mit 1 Rost cm.105x71 (inbegriffen 1 Abschluss-Element mod.TPC-9) • **FR** Cuisiniere gaz - N. 6 feux vifs Four électrique statique cm. 107x73x34h, temp: 50÷300°C, avec 1 grille cm.105x71 (inclus 1 Élément de jonction top mod.TPC-9) • **ES** Cocina a gas - N. 6 quemadores Horno eléctrico estático cm. 107x73x34h, temp: 50÷300°C, con 1 parilla cm.105x71 (incluida 1 Chapa de cierre para top mod.TPC-9)
cm. 120x 90x 90h



⚡ 45 kW
38.700 kcal/h

7.055,00
230 / 1,32

⚡ 9,2 kW
400V~3N
50/60 Hz

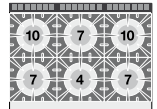

CF8-916G
09681650

CUCINA 8 FUOCHI - 2 FORNI GAS STATICI CM. 67X73X34H, TEMP: 150÷300°C, CON 2 GRIGLIE CM.65X71 GN2/1 (INCLUSA 1 TESTATA CHIUSURA PIANO MOD.TPC-9)

EN Gas Range - N. 8 burners - 2 Traditional gas-oven cm. 67x73x34h, temp: 150÷300°C, with 2 grids cm.65x71 GN2/1 (included 1 Head end filler strip mod.TPC-9) • **DE** Gasherd - N. 8 Kochstellen - 2 Statischer Gas-Backofen cm. 67x73x34h, temp: 150÷300°C, mit 2 Rost cm.65x71 GN2/1 (inbegriffen 1 Abschluss-Element mod.TPC-9) • **FR** Cuisiniere gaz - N. 8 feux - 2 Four à gaz statique cm. 67x73x34h, temp: 150÷300°C, avec 2 grille cm.65x71 GN2/1 (inclus 1 Élément de jonction top mod.TPC-9) • **ES** Cocina a gas - N. 8 quemadores - 2 Horno a gas estático cm. 67x73x34h, temp: 150÷300°C, con 2 parilla cm.65x71 GN2/1 (incluida 1 Chapa de cierre para top mod.TPC-9)
cm. 160x 90x 90h



⚡ 73 kW
62.780 kcal/h

9.469,00
318 / 1,76

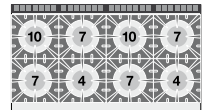

PC-94ET
09030430

PIANO COTTURA TRIFASE SU MOBILE A GIORNO - N. 2 PIASTRE (INCLUSA 1 TESTATA CHIUSURA PIANO MOD.TPA-9)

EN Boiling unit threephase on open cabinet - N. 2 plates (included 1 Head end filler strip mod.TPA-9) • **DE** Kochplatte dreiphasig mit offenem Unterbau - N. 2 Kochplatten (inbegriffen 1 Abschluss-Element mod.TPA-9) • **FR** Rechaud électriques sur armoire ouvert - N. 2 plaques (inclus 1 Élément de jonction top mod.TPA-9) • **ES** Sobre de cocción trifásico sobre mueble abierto - N. 2 planchas (incluida 1 Chapa de cierre para top mod.TPA-9)
cm. 40x 90x 90h



⚡ 7,0 kW
400V~2N
230V~3
230V~
50/60 Hz

1.727,00
53 / 0,46

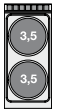

PC-98ET
09030830

PIANO COTTURA TRIFASE SU MOBILE A GIORNO N. 4 PIASTRE (INCLUSA 1 TESTATA CHIUSURA PIANO MOD.TPA-9)

EN Threephase boiling unit on open cabinet - N. 4 plates (included 1 Head end filler strip mod.TPA-9) • **DE** Kochplatte dreiphasig mit offenem Unterbau N. 4 Kochplatten (inbegriffen 1 Abschluss-Element mod.TPA-9) • **FR** Rechaud triphase sur armoire ouvert - N. 4 plaques (inclus 1 Élément de jonction top mod.TPA-9) • **ES** Sobre de cocción trifásico sobre mueble abierto N. 4 planchas (incluida 1 Chapa de cierre para top mod.TPA-9)
cm. 80x 90x 90h



⚡ 14,0 kW
400V~3N
50/60 Hz

3.202,00
86 / 0,89

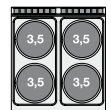

PIANI COTTURA ELETTRICI

MOD. _____
COD. _____

DESCRIZIONE/DESCRIPTION/BEZEICHNUNG/DESCRIPTION/DESCRIPCIÓN
DIMENSIONI/DIMENSIONS/ABMESSUNGEN/DIMENSIONS/DIMENSIONES

POTENZA/POWER/LEISTUNG/PUISSANCE/POTENCIA
VOLTAGGIO/VOLTAGE/SPANNUNG/VOLTAGE/VOLTAJE

⚡ kW _____
kcal/h _____
V~ _____
Hz _____

PREZZO/PRICE
PREIS/PRIX/PRECIO
KG / M³



PC-912ET
09031230

**PIANO COTTURA TRIFASE SU MOBILE A GIORNO N. 6
PIASTRE (INCLUSA 1 TESTATA CHIUSURA PIANO MOD.TPA-9)**

EN Threephase boiling unit on open cabinet - N. 6 plates (included 1 Head end filler strip mod.TPA-9) • **DE** Kochplatte dreiphasig mit offenem Unterbau N. 6 Kochplatten (inbegriffen 1 Abschluss-Element mod.TPA-9) • **FR** Rechaud triphasé sur armoire ouvert - N. 6 plaques (inclus 1 Élément de jonction top mod.TPA-9) • **ES** Sobre de cocción trifásico sobre mueble abierto N. 6 planchas (incluida 1 Chapa de cierre para top mod.TPA-9)

cm. 120x 90x 90h



⚡ 21,0 kW _____ **4.369,00**
400V~3N _____ 114 / 1,32
50/60 Hz

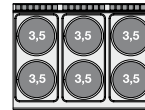

PCQ-94ET
09030431

**PIANO COTTURA TRIFASE SU MOBILE A GIORNO - N. 2
PIASTRE QUADRE (INCLUSA 1 TESTATA CHIUSURA PIANO MOD.TPA-9)**

EN Boiling unit threephase on open cabinet - N. 2 square plates (included 1 Head end filler strip mod.TPA-9) • **DE** Kochplatte dreiphasig mit offenem Unterbau N. 2 quadratischen Platten (inbegriffen 1 Abschluss-Element mod.TPA-9) • **FR** Rechaud électriques sur armoire ouvert - N. 2 plaques carrés (inclus 1 Élément de jonction top mod.TPA-9) • **ES** Sobre de cocción trifásico sobre mueble abierto N. 2 planchas cuadradas (incluida 1 Chapa de cierre para top mod.TPA-9)

cm. 40x 90x 90h



⚡ 8,0 kW _____ **2.276,00**
400V~2N _____ 57 / 0,46
230V~3
230V~
50/60 Hz



PCQ-98ET
09030831

**PIANO COTTURA TRIFASE SU MOBILE A GIORNO - N. 4
PIASTRE QUADRE (INCLUSA 1 TESTATA CHIUSURA PIANO MOD.TPA-9)**

EN Boiling unit threephase on open cabinet - N. 4 square plates (included 1 Head end filler strip mod.TPA-9) • **DE** Kochplatte dreiphasig mit offenem Unterbau N. 4 quadratischen Platten (inbegriffen 1 Abschluss-Element mod.TPA-9) • **FR** Rechaud électriques sur armoire ouvert - N. 4 plaques carrés (inclus 1 Élément de jonction top mod.TPA-9) • **ES** Sobre de cocción trifásico sobre mueble abierto N. 4 planchas cuadradas (incluida 1 Chapa de cierre para top mod.TPA-9)

cm. 80x 90x 90h



⚡ 16,0 kW _____ **4.114,00**
400V~3N _____ 94 / 0,89
50/60 Hz



PCQ-912ET
09031231

**PIANO COTTURA TRIFASE SU MOBILE A GIORNO - N. 6
PIASTRE QUADRE (INCLUSA 1 TESTATA CHIUSURA PIANO MOD.TPA-9)**

EN Boiling unit threephase on open cabinet - N. 6 square plates (included 1 Head end filler strip mod.TPA-9) • **DE** Kochplatte dreiphasig mit offenem Unterbau N. 6 quadratischen Platten (inbegriffen 1 Abschluss-Element mod.TPA-9) • **FR** Rechaud électriques sur armoire ouvert - N. 6 plaques carrés (inclus 1 Élément de jonction top mod.TPA-9) • **ES** Sobre de cocción trifásico sobre mueble abierto N. 6 planchas cuadradas (incluida 1 Chapa de cierre para top mod.TPA-9)

cm. 120x 90x 90h

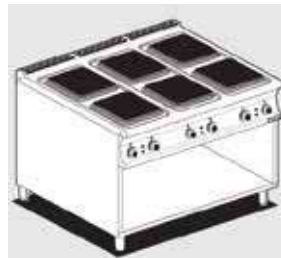

⚡ 24,0 kW _____ **5.665,00**
400V~3N _____ 129 / 1,32
50/60 Hz



PCC-94ET
09030432

**PIANO COTTURA VETROCERAMICA TRIFASE SU MOBILE
A GIORNO - N. 2 ZONE - VETRO CM.35X77 (INCLUSA 1
TESTATA CHIUSURA PIANO MOD.TPA-9)**

EN Ceramic glass boiling unit on open cabinet - n. 2 zones - glass cm.35x77 (included 1 Head end filler strip mod.TPA-9) • **DE** Ceran-Kochplatte dreiphasig mit offenem Unterbau - 2 zonen - Glas 35x77 cm (inbegriffen 1 Abschluss-Element mod.TPA-9) • **FR** Plan de cuisson à vitroceramique triphasé sur armoire ouvert N. 2 zones - Verre cm.35x77 (inclus 1 Élément de jonction top mod.TPA-9) • **ES** Sobre de cocción trifásico vitrocerámica sobre mueble abierto - 2 zonas - vidrio cm.35x77 (incluida 1 Chapa de cierre para top mod.TPA-9)

cm. 40x 90x 90h



⚡ 6,8 kW _____ **2.889,00**
400V~2N _____ 48 / 0,46
230V~3
230V~
50/60 Hz



PCC-98ET
09030832

**PIANO COTTURA VETROCERAMICA TRIFASE SU MOBILE A
GIORNO - N. 4 ZONE - VETRO CM. 75X77 (INCLUSA 1
TESTATA CHIUSURA PIANO MOD.TPA-9)**

EN Ceramic glass boiling unit on open cabinet - n. 4 zones - glass cm. 75 x 77 (included 1 Head end filler strip mod.TPA-9) • **DE** Ceran-Kochplatte dreiphasig mit offenem Unterbau - 4 zonen - Glas 75x77 cm (inbegriffen 1 Abschluss-Element mod.TPA-9) • **FR** Plan de cuisson à vitroceramique triphasé sur armoire ouvert N. 4 zones - Verre cm 75x77 (inclus 1 Élément de jonction top mod.TPA-9) • **ES** Sobre de cocción trifásico vitrocerámica sobre mueble abierto - 4 zonas - vidrio cm. 75 x 77 (incluida 1 Chapa de cierre para top mod.TPA-9)

cm. 80x 90x 90h



⚡ 13,6 kW _____ **4.652,00**
400V~3N _____ 74 / 0,89
230V~3
50/60 Hz



PIANI COTTURA A INDUZIONE

MOD. _____
COD. _____

DESCRIZIONE/DESCRIPTION/BEZEICHNUNG/DESCRIPTION/DESCRIPCIÓN
DIMENSIONI/DIMENSIONS/ABMESSUNGEN/DIMENSIONS/DIMENSIONES

POTENZA/POWER/LEISTUNG/PUISSANCE/POTENCIA
VOLTAGGIO/VOLTAGE/SPANNUNG/VOLTAGE/VOLTAJE

$\frac{kW}{kcal/h}$ $\frac{V}{Hz}$

PREZZO/PRICE
PREIS/PRIX/PRECIO
KG / M³



PCI-94ET
09030433

PIANO COTTURA INDUZIONE TRIFASE - N. 2 ZONE - VETRO CM.35X77 (INCLUSA 1 TESTATA CHIUSURA PIANO MOD. TPA-9)

EN Three-phase induction cooking - 2 zones - glass cm.35x77 (included 1 Head end filler strip mod.TPA-9) • **DE** Induktions-Kochplatte dreiphasig - 2 zonen - Glas 35x77 cm (inbegriffen 1 Abschluss-Element mod.TPA-9) • **FR** Plan de cuisson à induction triphasé N. 2 zones - Verre cm.35x77 (inclus 1 Élément de jonction top mod.TPA-9) • **ES** Encimera inducción trifásica - 2 zonas - Vidrio cm.35x77 (incluida 1 Chapa de cierre para top mod.TPA-9)

cm. 40x 90x 90h



$\frac{10 kW}{400V\sim3}$ **8.316,00**
 $\frac{50/60 Hz}{57 / 0,46}$

PCIW-94ET
09030434

PIANO COTTURA INDUZIONE TRIFASE "WOK" - N. 1 ZONA - VETRO Ø 30 CM. (INCLUSA 1 TESTATA CHIUSURA PIANO MOD.TPA-9)

EN Three-phase induction cooking "WOK" - 1 zone - glass Ø 30 cm (included 1 Head end filler strip mod.TPA-9) • **DE** Induktions-Kochplatte "WOK" dreiphasig - 1 zonen - Glas Ø 30 cm (inbegriffen 1 Abschluss-Element mod.TPA-9) • **FR** Plan de cuisson à induction "WOK" triphasé N. 1 zone - Verre cm Ø 30 (inclus 1 Élément de jonction top mod.TPA-9) • **ES** Encimera inducción "WOK" trifásica - 1 zona - Vidrio Ø 30 cm (incluida 1 Chapa de cierre para top mod.TPA-9)

cm. 40x 90x 90h



$\frac{5 kW}{400V\sim3}$ **6.242,00**
 $\frac{50/60 Hz}{53 / 0,46}$

PCI-98ET
09030833

PIANO COTTURA INDUZIONE TRIFASE - N. 4 ZONE - VETRO CM.75X77 (INCLUSA 1 TESTATA CHIUSURA PIANO MOD. TPA-9)

EN Three-phase induction cooking - 4 zones - glass cm.75x77 (included 1 Head end filler strip mod.TPA-9) • **DE** Induktions-Kochplatte dreiphasig - 4 zonen - Glas 75x77 cm (inbegriffen 1 Abschluss-Element mod.TPA-9) • **FR** Plan de cuisson à induction triphasé N. 4 zones - Verre cm.75x77 (inclus 1 Élément de jonction top mod.TPA-9) • **ES** Encimera inducción trifásica - 4 zonas - Vidrio cm.75x77 (incluida 1 Chapa de cierre para top mod.TPA-9)

cm. 80x 90x 90h



$\frac{20,0 kW}{400V\sim3}$ **15.868,00**
 $\frac{50/60 Hz}{94 / 0,89}$

PIANI COTTURA A GAS

MOD. _____
COD. _____

DESCRIZIONE/DESCRIPTION/BEZEICHNUNG/DESCRIPTION/DESCRIPCIÓN
DIMENSIONI/DIMENSIONS/ABMESSUNGEN/DIMENSIONS/DIMENSIONES

POTENZA/POWER/LEISTUNG/PUISSANCE/POTENCIA
VOLTAGGIO/VOLTAGE/SPANNUNG/VOLTAGE/VOLTAJE

⚡ kW kcal/h
⚡ kw kcal/h
V~ Hz

PREZZO/PRICE
PREIS/PRIX/PRECIO
KG / M³



PC-94G
09210450

**PIANO COTTURA GAS SU MOBILE A GIORNO 2 FUOCHI
(INCLUSA 1 TESTATA CHIUSURA PIANO MOD.TPC-9)**

EN Gas heated boiling unit on open cabinet - 2 burners (included 1 Head end filler strip mod.TPC-9) • **DE** Gas-kochplatte mit offenem Unterbau - 2 Kochstellen (inbegriffen 1 Abschluss-Element mod.TPC-9) • **FR** Rechaud gaz sur armoire ouvert - 2 feux vifs (inclus 1 Élément de jonction top mod.TPC-9) • **ES** Sobres de cocción gas sobre mueble abierto - 2 quemadores (incluida 1 Chapa de cierre para top mod.TPC-9)
cm. 40x 90x 90h



⚡ 11 kW
9.460 kcal/h

2.050,00
71 / 0,46



PC-98G
09210850

**PIANO COTTURA GAS SU MOBILE A GIORNO 4 FUOCHI
(INCLUSA 1 TESTATA CHIUSURA PIANO MOD.TPC-9)**

EN Gas heated boiling unit on open cabinet - 4 burners (included 1 Head end filler strip mod.TPC-9) • **DE** Gas-Kochplatte mit offenem Unterbau - 4 Kochstellen (inbegriffen 1 Abschluss-Element mod.TPC-9) • **FR** Rechaud gaz sur armoire ouvert - 4 feux vifs (inclus 1 Élément de jonction top mod.TPC-9) • **ES** Sobres de cocción gas sobre mueble abierto - 4 quemadores (incluida 1 Chapa de cierre para top mod.TPC-9)
cm. 80x 90x 90h



⚡ 28 kW
24.080 kcal/h

3.270,00
100 / 0,89

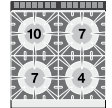

PC-912G
09211250

**PIANO COTTURA GAS SU MOBILE A GIORNO 6 FUOCHI
(INCLUSA 1 TESTATA CHIUSURA PIANO MOD.TPC-9)**

EN Gas heated boiling unit on open cabinet - 6 burners (included 1 Head end filler strip mod.TPC-9) • **DE** Gas-Kochplatte mit offenem Unterbau - 6 Kochstellen (inbegriffen 1 Abschluss-Element mod.TPC-9) • **FR** Rechaud gaz sur armoire ouvert - 6 feux vifs (inclus 1 Élément de jonction top mod.TPC-9) • **ES** Sobres de cocción gas sobre mueble abierto - 6 quemadores (incluida 1 Chapa de cierre para top mod.TPC-9)
cm. 120x 90x 90h



⚡ 45 kW
38.700 kcal/h

4.726,00
142 / 1,32

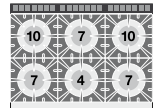

PC-916G
09211650

**PIANO COTTURA GAS SU MOBILE A GIORNO - 8 FUOCHI
(INCLUSA 1 TESTATA CHIUSURA PIANO MOD.TPC-9)**

EN Gas heated boiling unit on open cabinet - 8 burners (included 1 Head end filler strip mod.TPC-9) • **DE** Gas-Kochplatte mit offenem Unterbau - 8 Kochstellen (inbegriffen 1 Abschluss-Element mod.TPC-9) • **FR** Rechaud gaz sur armoire ouvert - 8 feux vifs (inclus 1 Élément de jonction top mod.TPC-9) • **ES** Sobres de cocción gas sobre mueble abierto 8 quemadores (incluida 1 Chapa de cierre para top mod.TPC-9)
cm. 160x 90x 90h



⚡ 56 kW
48.160 kcal/h

6.206,00
182 / 1,76

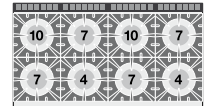

PCA-94G
09310450

**PIANO COTTURA ACQUA SU MOBILE A GIORNO 2 FUOCHI
- RUBINETTO CARICO ACQUA, SFIORATORE (INCLUSA 1
TESTATA CHIUSURA PIANO MOD.TPA-9)**

EN water heated boiling unit on open cabinet - 2 burners - Water loading tap + overflow device (included 1 Head end filler strip mod.TPA-9) • **DE** wasser-Kochplatte mit offenem Unterbau - 2 Kochstellen - Wasserlauf-Hahn + Überlauf-Vorrichtung (inbegriffen 1 Abschluss-Element mod.TPA-9) • **FR** Rechaud l'eau sur armoire ouvert - 2 feux vifs - Robinet d'arrivée d'eau trop plein (inclus 1 Élément de jonction top mod.TPA-9) • **ES** Sobres de cocción agua sobre mueble abierto 2 quemadores - Grifo carga agua + vertedero (incluida 1 Chapa de cierre para top mod.TPA-9)
cm. 40x 90x 90h



⚡ 14 kW
12.040 kcal/h

2.565,00
71 / 0,46

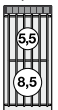

PCA-98G
09310850

**PIANO COTTURA ACQUA SU MOBILE A GIORNO - 4 FUOCHI
- RUBINETTO CARICO ACQUA, SFIORATORE (INCLUSA 1
TESTATA CHIUSURA PIANO MOD.TPA-9)**

EN water heated boiling unit on open cabinet - 4 burners - Water loading tap + overflow device (included 1 Head end filler strip mod.TPA-9) • **DE** wasser-kochplatte mit offenem Unterbau - 4 Kochstellen - Wasserlauf-Hahn + Überlauf-Vorrichtung (inbegriffen 1 Abschluss-Element mod.TPA-9) • **FR** Rechaud l'eau sur armoire ouvert - 4 feux vifs - Robinet d'arrivée d'eau trop plein (inclus 1 Élément de jonction top mod.TPA-9) • **ES** Sobres de cocción agua sobre mueble abierto 4 quemadores - Grifo carga agua + vertedero (incluida 1 Chapa de cierre para top mod.TPA-9)
cm. 80x 90x 90h



⚡ 28 kW
24.080 kcal/h

4.113,00
100 / 0,89



PIANI COTTURA AD ACQUA A GAS

MOD. _____
COD. _____

DESCRIZIONE/DESCRIPTION/BEZEICHNUNG/DESCRIPTION/DESCRIPCIÓN
DIMENSIONI/DIMENSIONS/ABMESSUNGEN/DIMENSIONS/DIMENSIONES

POTENZA/POWER/LEISTUNG/PUISSANCE/POTENCIA
VOLTAGGIO/VOLTAGE/SPANNUNG/VOLTAGE/VOLTAJE

⚡ $\frac{\text{kW}}{\text{kcal/h}}$ $\frac{\text{V}}{\text{Hz}}$

PREZZO/PRICE
PREIS/PRIX/PRECIO
KG / M³



PCA-912G
09311250

PIANO COTTURA ACQUA SU MOBILE A GIORNO 6 FUOCHI - RUBINETTO CARICO ACQUA, SFIORATORE (INCLUSA 1 TESTATA CHIUSURA PIANO MOD.TPA-9)

EN water heated boiling unit on open cabinet - 6 burners - Water loading tap + overflow device (included 1 Head end filler strip mod.TPA-9) • **DE** wasser-kochplatte mit offenem Unterbau - 6 Kochstellen - Wasserlauf-Hahn + Überlauf-Vorrichtung (inbegriffen 1 Abschluss-Element mod.TPA-9) • **FR** Rechaud l'eau sur armoire ouvert - 6 feux vifs - Robinet d'arrivée d'eau trop plein (inclus 1 Élément de jonction top mod.TPA-9) • **ES** Sobres de cocción agua sobre mueble abierto 6 quemadores - Grifo carga agua + vertedero (incluida 1 Chapa de cierre para top mod.TPA-9)
cm. 120x 90x 90h

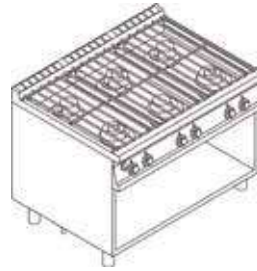

⚡ $\frac{42 \text{ kW}}{36.120 \text{ kcal/h}}$ **5.938,00**
142 / 1,32

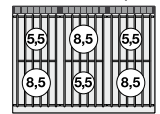

PA-98G
09210851

"PAELLERO" GAS SU MOBILE A GIORNO (INCLUSA 1 TESTATA CHIUSURA PIANO MOD.TPC-9)

EN "PAELLERO" Gas - open cabinet (included 1 Head end filler strip mod.TPC-9) • **DE** "PAELLERO" Gas mit offenem Unterbau (inbegriffen 1 Abschluss-Element mod.TPC-9) • **FR** "PAELLERO" gaz sur armoire ouvert (inclus 1 Élément de jonction top mod.TPC-9) • **ES** "PAELLERO" gas sobre mueble abierto (incluida 1 Chapa de cierre para top mod.TPC-9)
cm. 80x 90x 90h



⚡ $\frac{26,7 \text{ kW}}{22.962 \text{ kcal/h}}$ **4.691,00**
134 / 0,89

PAF-98G
09680851

"PAELLERO" GAS SU FORNO GAS STATICO CM. 67X73X34H, TEMP: 150÷300°C, CON 1 GRIGLIA CM.65X71 GN2/1 (INCLUSA 1 TESTATA CHIUSURA PIANO MOD.TPC-9)

EN "PAELLERO" Gas on Traditional gas-oven cm. 67x73x34h, temp: 150÷300°C, with 1 grid cm.65x71 GN2/1 (included 1 Head end filler strip mod.TPC-9) • **DE** "PAELLERO" Gas mit Statischer Gas-Backofen cm. 67x73x34h, temp: 150÷300°C, mit 1 Rost cm.65x71 GN2/1 (inbegriffen 1 Abschluss-Element mod.TPC-9) • **FR** "PAELLERO" gaz sur Four à gaz statique cm. 67x73x34h, temp: 150÷300°C, avec 1 grille cm.65x71 GN2/1 (inclus 1 Élément de jonction top mod.TPC-9) • **ES** "PAELLERO" gas sobre Horno a gas estático cm. 67x73x34h, temp: 150÷300°C, con 1 parilla cm.65x71 GN2/1 (incluida 1 Chapa de cierre para top mod.TPC-9)
cm. 80x 90x 90h



⚡ $\frac{35,2 \text{ kW}}{30.272 \text{ kcal/h}}$ **6.191,00**
184 / 0,89

TP-94G
09290450

TUTTA PIASTRA GAS SU MOBILE A GIORNO PIASTRA CM 39X73 (INCLUSA 1 TESTATA CHIUSURA PIANO MOD.TPC-9)

EN Solid top on open unit - plate 39x73 cm (included 1 Head end filler strip mod.TPC-9) • **DE** Kochplatte auf offenem Unterbau - Platte 39x73 cm (inbegriffen 1 Abschluss-Element mod.TPC-9) • **FR** Toute plaque sur meuble ouvert - Plaque cm 39x73 (inclus 1 Élément de jonction top mod.TPC-9) • **ES** Placa de cocción sobre mueble abierto - Placa cm 39x73 (incluida 1 Chapa de cierre para top mod.TPC-9)
cm. 40x 90x 90h



⚡ $\frac{7 \text{ kW}}{6.020 \text{ kcal/h}}$ **2.461,00**
75 / 0,46

TP-98G
09290850

TUTTA PIASTRA GAS SU MOBILE A GIORNO PIASTRA CM 79X73 (INCLUSA 1 TESTATA CHIUSURA PIANO MOD.TPC-9)

EN Solid top on open unit - Plate 79x73 cm (included 1 Head end filler strip mod.TPC-9) • **DE** Kochplatte auf offenem Unterbau - Platte 79x73 cm (inbegriffen 1 Abschluss-Element mod.TPC-9) • **FR** Toute plaque sur meuble ouvert - Plaque cm 79x73 (inclus 1 Élément de jonction top mod.TPC-9) • **ES** Placa de cocción sobre mueble abierto - Placa cm 79x73 (incluida 1 Chapa de cierre para top mod.TPC-9)
cm. 80x 90x 90h



⚡ $\frac{12 \text{ kW}}{10.320 \text{ kcal/h}}$ **3.611,00**
144 / 0,89

90

TUTTAPIASTRA A GAS

MOD. _____
COD. _____

DESCRIZIONE/DESCRIPTION/BEZEICHNUNG/DESCRIPTION/DESCRIPCIÓN
DIMENSIONI/DIMENSIONS/ABMESSUNGEN/DIMENSIONS/DIMENSIONES

POTENZA/POWER/LEISTUNG/PUISSANCE/POTENCIA
VOLTAGGIO/VOLTAGE/SPANNUNG/VOLTAGE/VOLTAJE

⚡ kW
kcal/h

⚡ kw
V~
Hz

PREZZO/PRICE
PREIS/PRIX/PRECIO
KG / M³



TP2-98G
09300850

TUTTA PIASTRA + 2 FUOCHI SU MOBILE A GIORNO PIASTRA CM. 39X73 (INCLUSA 1 TESTATA CHIUSURA PIANO MOD. TPC-9)

EN Solid top + 2 burners on open unit Plate 39x73 (included 1 Head end filler strip mod.TPC-9) • **DE** Kochplatte + 2 Gaskochstellen auf offenem Unterbau Platte 39x73 (inbegriffen 1 Abschluss-Element mod.TPC-9) • **FR** Toute plaque + 2 brûleurs sur meuble ouvert Plaque cm. 39x73 (inclus 1 Élément de jonction top mod.TPC-9) • **ES** Placa de cocción + 2 fuegos sobre mueble abierto Placa cm. 39x73 (incluida 1 Chapa de cierre para top mod.TPC-9)
cm. 80x 90x 90h



⚡ 24 kW
20.640 kcal/h

3.598,00
139 / 0,89

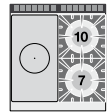

TP2-912G
09291250

TUTTA PIASTRA + 2 FUOCHI SU MOBILE A GIORNO PIASTRA CM. 79X73 (INCLUSA 1 TESTATA CHIUSURA PIANO MOD. TPC-9)

EN Solid top + 2 burners on open unit Plate 79x73 (included 1 Head end filler strip mod.TPC-9) • **DE** Kochplatte + 2 Gaskochstellen auf offenem Unterbau Platte 79x73 (inbegriffen 1 Abschluss-Element mod.TPC-9) • **FR** Toute plaque + 2 brûleurs sur meuble ouvert Plaque cm. 79x73 (inclus 1 Élément de jonction top mod.TPC-9) • **ES** Placa de cocción + 2 fuegos sobre mueble abierto Placa cm. 79x73 (incluida 1 Chapa de cierre para top mod.TPC-9)
cm. 120x 90x 90h



⚡ 29 kW
24.940 kcal/h

5.218,00
166 / 1,32

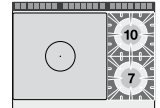

TP4-912G
09301250

TUTTA PIASTRA + 4 FUOCHI SU MOBILE A GIORNO PIASTRA CM. 39X73 (INCLUSA 1 TESTATA CHIUSURA PIANO MOD. TPC-9)

EN Solid top + 4 burners on open unit Plate 39x73 cm (included 1 Head end filler strip mod.TPC-9) • **DE** Kochplatte + 4 Gaskochstellen auf offenem Unterbau Platte 39x73 cm (inbegriffen 1 Abschluss-Element mod.TPC-9) • **FR** Toute plaque + 4 brûleurs sur meuble ouvert Plaque cm. 39x73 (inclus 1 Élément de jonction top mod.TPC-9) • **ES** Placa de cocción + 4 fuegos sobre mueble abierto Placa cm. 39x73 (incluida 1 Chapa de cierre para top mod.TPC-9)
cm. 120x 90x 90h



⚡ 35 kW
30.100 kcal/h

4.998,00
160 / 1,32

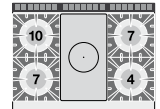

TP-98ET
09120830

TUTTA PIASTRA SU MOBILE A GIORNO PIASTRA CM. 70X68 - 4 ZONE (INCLUSA 1 TESTATA CHIUSURA PIANO MOD.TPA-9)

EN Solid top on open unit - Plate cm. 70x68 (included 1 Head end filler strip mod.TPA-9) • **DE** Kochplatten auf offenem Unterbau - Platte cm. 70x68 (inbegriffen 1 Abschluss-Element mod.TPA-9) • **FR** Toute plaque sur meuble ouvert - Plaque cm. 70x68 (inclus 1 Élément de jonction top mod.TPA-9) • **ES** Placa de cocción sobre mueble abierto - Placa cm. 70x68 (incluida 1 Chapa de cierre para top mod.TPA-9)
cm. 80x 90x 90h



⚡ 13,6 kW
400V~3N
50/60 Hz

4.406,00
114 / 0,89

TPI-98ET
09120833

TUTTOPIANO INDUZIONE TRIFASE - VETRO CM.75X77 (INCLUSA 1 TESTATA CHIUSURA PIANO MOD.TPA-9)

EN Three-phase induction Solid top - glass cm.75x77 (included 1 Head end filler strip mod.TPA-9) • **DE** Induktions-Kochplatte dreiphasig - Glas 75x77 cm (inbegriffen 1 Abschluss-Element mod.TPA-9) • **FR** Toute plaque à induction triphasé - Verre cm.75x77 (inclus 1 Élément de jonction top mod.TPA-9) • **ES** Placa de cocción inducción trifásica - Vidrio cm.75x77 (incluida 1 Chapa de cierre para top mod.TPA-9)
cm. 80x 90x 90h



⚡ 28 kW
400V~3
50/60 Hz

23.778,00
95 / 0,89

TUTTAPIASTRA ELETTRICO CON FORNO

MOD. _____
COD. _____

DESCRIZIONE/DESCRIPTION/BEZEICHNUNG/DESCRIPTION/DESCRIPCIÓN
DIMENSIONI/DIMENSIONS/ABMESSUNGEN/DIMENSIONS/DIMENSIONES

POTENZA/POWER/LEISTUNG/PUISSANCE/POTENCIA
VOLTAGGIO/VOLTAGE/SPANNUNG/VOLTAGE/VOLTAJE

⚡ kW
kcal/h

PREZZO/PRICE
PREIS/PRIX/PRECIO
KG / M³



TPF-98ET
09670830

TUTTA PIASTRA SU FORNO ELETTRICO STATICO CM. 67X73X34H, TEMP: 50÷300°C, CON 1 GRIGLIA CM.65X71 GN2/1 - PIASTRA CM. 70X68 4 ZONE (INCLUSA 1 TESTATA CHIUSURA PIANO MOD.TPA-9)
EN Solid top on traditional electric cm. 67x73x34h, temp: 50÷300°C, with 1 grid cm.65x71 GN2/1 - Plate cm. 70x68 4 zones (included 1 Head end filler strip mod.TPA-9) • **DE** Kochplatten - Statischer Elektro-Backofen cm. 67x73x34h, temp: 50÷300°C, mit 1 Rost cm.65x71 GN2/1 - Platte cm. 70x68 4 zonen (inbegriffen 1 Abschluss-Element mod.TPA-9) • **FR** Toute plaque sur Four électrique statique cm. 67x73x34h, temp: 50÷300°C, avec 1 grille cm.65x71 GN2/1 - Plaque cm. 70x68 4 zones (inclus 1 Élément de jonction top mod.TPA-9) • **ES** Placa de cocción sobre Horno eléctrico estático cm. 67x73x34h, temp: 50÷300°C, con 1 parilla cm.65x71 GN2/1 - Placa cm. 70x68 4 zonas (incluida 1 Chapa de cierre para top mod.TPA-9)
cm. 80x 90x 90h



⚡ 20,3 kW
400V~3N
50/60 Hz

5.746,00
180 / 0,89

TPFV-98ET
09670835

TUTTA PIASTRA SU FORNO ELETTRICO VENTILATO CM. 55X36X34H, TEMP: 50÷300°C, CON 1 GRIGLIA CM.53X32,5 GN1/1 - PIASTRA CM. 70X68 4 ZONE (INCLUSA 1 TESTATA CHIUSURA PIANO MOD.TPA-9)
EN Solid top on electric fan oven cm. 55x36x34h, temp: 50÷300°C, with 1 grid cm.53x32,5 GN1/1 - Plate cm. 70x68 4 zones (included 1 Head end filler strip mod.TPA-9) • **DE** Kochplatten - Elektro-Heißluftofen cm. 55x36x34h, temp: 50÷300°C, mit 1 Rost cm.53x32,5 GN1/1 - Platte cm. 70x68 4 Zonen (inbegriffen 1 Abschluss-Element mod.TPA-9) • **FR** Toute plaque sur Four à chaleur tournante électrique cm. 55x36x34h, temp: 50÷300°C, avec 1 grille cm.53x32,5 GN1/1 - Plaque cm. 70x68 4 zones (inclus 1 Élément de jonction top mod.TPA-9) • **ES** Placa de cocción sobre Horno eléctrico ventilado cm. 55x36x34h, temp: 50÷300°C, con 1 parilla cm.53x32,5 GN1/1 - Placa cm. 70x68 4 zonas (incluida 1 Chapa de cierre para top mod.TPA-9)
cm. 80x 90x 90h

⚡ 18,92 kW
400V~3N
50/60 Hz

6.196,00
180 / 0,89

TPF-98G
09700850

TUTTA PIASTRA SU FORNO GAS STATICO CM. 67X73X34H, TEMP: 150÷300°C, CON 1 GRIGLIA CM.65X71 GN2/1 - PIASTRA CM 79X73 (INCLUSA 1 TESTATA CHIUSURA PIANO MOD.TPC-9)
EN Solid top on Traditional gas-oven cm. 67x73x34h, temp: 150÷300°C, with 1 grid cm.65x71 GN2/1 - Plate cm. 79x73 (included 1 Head end filler strip mod.TPC-9) • **DE** Kochplatten - Statischer Gas-Backofen cm. 67x73x34h, temp: 150÷300°C, mit 1 Rost cm.65x71 GN2/1 - Platte cm. 79x73 (inbegriffen 1 Abschluss-Element mod.TPC-9) • **FR** Toute plaque sur Four à gaz statique cm. 67x73x34h, temp: 150÷300°C, avec 1 grille cm.65x71 GN2/1 - Plaque cm. 79x73 (inclus 1 Élément de jonction top mod.TPC-9) • **ES** Placa de cocción sobre Horno a gas estático cm. 67x73x34h, temp: 150÷300°C, con 1 parilla cm.65x71 GN2/1 - Placa cm. 79x73 (incluida 1 Chapa de cierre para top mod.TPC-9)
cm. 80x 90x 90h



⚡ 20,5 kW
17.630 kcal/h

5.271,00
194 / 0,89

TPF-98GE
09710860

TUTTA PIASTRA SU FORNO ELETTRICO STATICO CM. 67X73X34H, TEMP: 50÷300°C, CON 1 GRIGLIA CM.65X71 GN2/1 - PIASTRA CM. 79X73 (INCLUSA 1 TESTATA CHIUSURA PIANO MOD.TPC-9)
EN Solid top on traditional electric oven cm. 67x73x34h, temp: 50÷300°C, with 1 grid cm.65x71 GN2/1 - Plate cm. 79x73 (included 1 Head end filler strip mod.TPC-9) • **DE** Kochplatten - Statischer Elektro-Backofen cm. 67x73x34h, temp: 50÷300°C, mit 1 Rost cm.65x71 GN2/1 - Platte cm. 79x73 (inbegriffen 1 Abschluss-Element mod.TPC-9) • **FR** Toute plaque sur Four électrique statique cm. 67x73x34h, temp: 50÷300°C, avec 1 grille cm.65x71 GN2/1 - Plaque cm. 79x73 (inclus 1 Élément de jonction top mod.TPC-9) • **ES** Placa de cocción sobre Horno eléctrico estático cm. 67x73x34h, temp: 50÷300°C, con 1 parilla cm.65x71 GN2/1 - Placa cm. 79x73 (incluida 1 Chapa de cierre para top mod.TPC-9)
cm. 80x 90x 90h



⚡ 12 kW
10.320 kcal/h

5.380,00
196 / 0,89

⚡ 6,7 kW
400V~3N
50/60 Hz

TUTTAPIASTRA A GAS CON FORNO ELETTRICO

MOD. _____
COD. _____

DESCRIZIONE/DESCRIPTION/BEZEICHNUNG/DESCRIPTION/DESCRIPCIÓN
DIMENSIONI/DIMENSIONS/ABMESSUNGEN/DIMENSIONS/DIMENSIONES

POTENZA/POWER/LEISTUNG/PUISSANCE/POTENCIA
VOLTAGGIO/VOLTAGE/SPANNUNG/VOLTAGE/VOLTAJE

⚡ kW
kcal/h

⚡ kW
V~
Hz

PREZZO/PRICE
PREIS/PRIX/PRECIO
KG / M³



TPFV-98GE
09710865

TUTTA PIASTRA SU FORNO ELETTRICO VENTILATO CM. 55X36X34H, TEMP: 50÷300°C, CON 1 GRIGLIA CM.53X32,5 GN1/1 - PIASTRA CM. 79X73 (INCLUSA 1 TESTATA CHIUSURA PIANO MOD.TPC-9)

EN Solid top on electric fan oven cm. 55x36x34h, temp: 50÷300°C, with 1 grid cm.53x32,5 GN1/1 - Plate cm. 79x73 (included 1 Head end filler strip mod.TPC-9) • **DE** Kochplatten - Elektro-Heißluftofen cm. 55x36x34h, temp: 50÷300°C, mit 1 Rost cm.53x32,5 GN1/1 - Platte cm. 79x73 (inbegriffen 1 Abschluss-Element mod.TPC-9) • **FR** Toute plaque sur Four à chaleur tournante électrique cm. 55x36x34h, temp: 50÷300°C, avec 1 grille cm.53x32,5 GN1/1 - Plaque cm. 79x73 (inclus 1 Élément de jonction top mod.TPC-9) • **ES** Placa de cocción sobre Horno eléctrico ventilado cm. 55x36x34h, temp: 50÷300°C, con 1 parilla cm.53x32,5 GN1/1 - Placa cm. 79x73 (incluida 1 Chapa de cierre para top mod.TPC-9)

cm. 80x 90x 90h



⚡ 12 kW
10.320 kcal/h

5.820,00
196 / 0,89

⚡ 5,32 kW
400V~3N
230V~3
50/60 Hz

TPF2-98G
09720850

TUTTA PIASTRA + 2 FUOCHI SU FORNO GAS STATICO CM. 67X73X34H, TEMP: 150÷300°C, CON 1 GRIGLIA CM.65X71 GN2/1 - PIASTRA CM 39X73 (INCLUSA 1 TESTATA CHIUSURA PIANO MOD.TPC-9)

EN Solid top + 2 burners Traditional gas-oven cm. 67x73x34h, temp: 150÷300°C, with 1 grid cm.65x71 GN2/1 - Plate 39x73 (included 1 Head end filler strip mod.TPC-9) • **DE** Kochplatte + 2 Gaskochstellen auf Statischer Gas-Backofen cm. 67x73x34h, temp: 150÷300°C, mit 1 Rost cm.65x71 GN2/1 - Platte 39x73 cm (inbegriffen 1 Abschluss-Element mod.TPC-9) • **FR** Toute plaque + 2 brûleurs sur Four à gaz statique cm. 67x73x34h, temp: 150÷300°C, avec 1 grille cm.65x71 GN2/1 - Plaque cm. 39x73 (inclus 1 Élément de jonction top mod.TPC-9) • **ES** Placa de cocción + 2 fuegos sobre Horno a gas estático cm. 67x73x34h, temp: 150÷300°C, con 1 parilla cm.65x71 GN2/1 - Placa cm 39x73 (incluida 1 Chapa de cierre para top mod.TPC-9)

cm. 80x 90x 90h



⚡ 32,5 kW
27.950 kcal/h

5.307,00
181 / 0,89

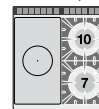

TPF2-98GE
09730860

TUTTA PIASTRA + 2 FUOCHI SU FORNO ELETTRICO STATICO CM. 67X73X34H, TEMP: 50÷300°C, CON 1 GRIGLIA CM.65X71 GN2/1 - PIASTRA CM 39X73 (INCLUSA 1 TESTATA CHIUSURA PIANO MOD.TPC-9)

EN Solid top + 2 burners traditional electric oven cm. 67x73x34h, temp: 50÷300°C, with 1 grid cm.65x71 GN2/1 - Plate 39x73 (included 1 Head end filler strip mod.TPC-9) • **DE** Kochplatte + 2 Gaskochstellen auf Statischer Elektro-Backofen cm. 67x73x34h, temp: 50÷300°C, mit 1 Rost cm.65x71 GN2/1 - Platte 39x73 (inbegriffen 1 Abschluss-Element mod.TPC-9) • **FR** Toute plaque + 2 brûleurs sur Four électrique statique cm. 67x73x34h, temp: 50÷300°C, avec 1 grille cm.65x71 GN2/1 - Plaque cm. 39x73 (inclus 1 Élément de jonction top mod.TPC-9) • **ES** Placa de cocción + 2 fuegos sobre Horno eléctrico estático GN 2/1 cm. 68x73x34h, temp: 50÷300°C, Placa cm 39x73 (incluida 1 Chapa de cierre para top mod.TPC-9)

cm. 80x 90x 90h



⚡ 24 kW
20.640 kcal/h

5.415,00
191 / 0,89

⚡ 6,7 kW
400V~3N
50/60 Hz

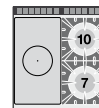

TPFV2-98GE
09730865

TUTTA PIASTRA + 2 FUOCHI SU FORNO ELETTRICO VENTILATO CM. 55X36X34H, TEMP: 50÷300°C, CON 1 GRIGLIA CM.53X32,5 GN1/1 - PIASTRA CM 39X73 (INCLUSA 1 TESTATA CHIUSURA PIANO MOD.TPC-9)

EN Solid top + 2 burners electric fan oven cm. 55x36x34h, temp: 50÷300°C, with 1 grid cm.53x32,5 GN1/1 - Plate 39x73 (included 1 Head end filler strip mod.TPC-9) • **DE** Kochplatte + 2 Gaskochstellen - Elektro-Heißluftofen cm. 55x36x34h, temp: 50÷300°C, mit 1 Rost cm.53x32,5 GN1/1 - Platte 39x73 (inbegriffen 1 Abschluss-Element mod.TPC-9) • **FR** Toute plaque + 2 brûleurs sur Four à chaleur tournante électrique cm. 55x36x34h, temp: 50÷300°C, avec 1 grille cm.53x32,5 GN1/1 - Plaque cm. 39x73 (inclus 1 Élément de jonction top mod.TPC-9) • **ES** Placa de cocción + 2 fuegos sobre Horno eléctrico ventilado cm. 55x36x34h, temp: 50÷300°C, con 1 parilla cm.53x32,5 GN1/1 - Placa cm 39x73 (incluida 1 Chapa de cierre para top mod.TPC-9)

cm. 80x 90x 90h

⚡ 24 kW
20.640 kcal/h

5.853,00
191 / 0,89

⚡ 5,32 kW
400V~3N
230V~3
50/60 Hz

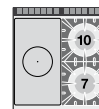

TUTTAPIASTRA A GAS CON FORNO

MOD. _____
COD. _____

DESCRIZIONE/DESCRIPTION/BEZEICHNUNG/DESCRIPTION/DESCRIPCIÓN
DIMENSIONI/DIMENSIONS/ABMESSUNGEN/DIMENSIONS/DIMENSIONES

POTENZA/POWER/LEISTUNG/PUISSANCE/POTENCIA
VOLTAGGIO/VOLTAGE/SPANNUNG/VOLTAGE/VOLTAJE

⚡ kW
kcal/h

⚡ kW
V~
Hz

PREZZO/PRICE
PREIS/PRIX/PRECIO
KG / M³



TPF2-912GV TUTTA PIASTRA + 2 FUOCHI SU FORNO GAS STATICO CM. 67X73X34H, TEMP: 150÷300°C, CON 1 GRIGLIA CM.65X71 GN2/1 - PIASTRA CM 79X73 - VANO NEUTRO CON PORTA (INCLUSA 1 TESTATA CHIUSURA PIANO MOD.TPC-9)

09701251

EN Solid top + 2 burners Traditional gas-oven cm. 67x73x34h, temp: 150÷300°C, with 1 grid cm.65x71 GN2/1 - Plate 79x73 cm - Neutral cabinet with door (included 1 Head end filler strip mod.TPC-9) • **DE** Kochplatte + 2 Gaskochstellen auf Statischer Gas-Backofen cm. 67x73x34h, temp: 150÷300°C, mit 1 Rost cm.65x71 GN2/1 - Platte 79x73 cm - Neutrales Schrankelement mit Tür (inbegriffen 1 Abschluss-Element mod.TPC-9) • **FR** Toute plaque + 2 brûleurs sur Four à gaz statique cm. 67x73x34h, temp: 150÷300°C, avec 1 grille cm.65x71 GN2/1 - Plaque cm. 79x73 - Element neutre avec porte (inclus 1 Élément de jonction top mod.TPC-9) • **ES** Placa de cocción + 2 fuegos sobre Horno a gas estático cm. 67x73x34h, temp: 150÷300°C, con 1 parilla cm.65x71 GN2/1 - Placa cm 79x73 - Armario neutro con puerta (incluida 1 Chapa de cierre para top mod.TPC-9)
cm. 120x 90x 90h



⚡ 37,5 kW
32.250 kcal/h

7.094,00
254 / 1,32

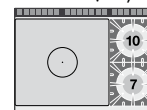

TPF2-912GEV TUTTA PIASTRA + 2 FUOCHI SU FORNO ELETTRICO STATICO CM. 67X73X34H, TEMP: 50÷300°C, CON 1 GRIGLIA CM.65X71 GN2/1 - PIASTRA CM 79X73 - VANO NEUTRO CON PORTA (INCLUSA 1 TESTATA CHIUSURA PIANO MOD. TPC-9)

09711261

EN Solid top + 2 burners traditional electric oven cm. 67x73x34h, temp: 50÷300°C, with 1 grid cm.65x71 GN2/1 - Plate 79x73 cm - Neutral cabinet with door (included 1 Head end filler strip mod.TPC-9) • **DE** Kochplatte + 2 Gaskochstellen auf Statischer Elektro-Backofen cm. 67x73x34h, temp: 50÷300°C, mit 1 Rost cm.65x71 GN2/1 - Platte 79x73 cm - Neutrales Schrankelement mit Tür (inbegriffen 1 Abschluss-Element mod.TPC-9) • **FR** Toute plaque + 2 brûleurs sur Four électrique statique cm. 67x73x34h, temp: 50÷300°C, avec 1 grille cm.65x71 GN2/1 - Plaque cm. 79x73 - Element neutre avec porte (inclus 1 Élément de jonction top mod.TPC-9) • **ES** Placa de cocción + 2 fuegos sobre Horno eléctrico estático cm. 67x73x34h, temp: 50÷300°C, con 1 parilla cm.65x71 GN2/1 - Placa cm 79x73 - Armario neutro con puerta (incluida 1 Chapa de cierre para top mod.TPC-9)
cm. 120x 90x 90h



⚡ 29 kW
24.940 kcal/h

7.203,00
250 / 1,32

⚡ 6,7 kW
400V~3N
50/60 Hz

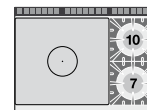

TPFV2-912GEV TUTTA PIASTRA + 2 FUOCHI SU FORNO ELETTRICO VENTILATO CM. 55X36X34H, TEMP: 50÷300°C, CON 1 GRIGLIA CM.53X32,5 GN1/1 - PIASTRA CM 79X73 - VANO NEUTRO CON PORTA (INCLUSA 1 TESTATA CHIUSURA PIANO MOD.TPC-9)

09711266

EN Solid top + 2 burners electric fan oven cm. 55x36x34h, temp: 50÷300°C, with 1 grid cm.53x32,5 GN1/1 - Plate 79x73 cm - Neutral cabinet with door (included 1 Head end filler strip mod.TPC-9) • **DE** Kochplatte + 2 Gaskochstellen - Elektro-Heißluftofen cm. 55x36x34h, temp: 50÷300°C, mit 1 Rost cm.53x32,5 GN1/1 - Platte 79x73 cm - Neutrales Schrankelement mit Tür (inbegriffen 1 Abschluss-Element mod.TPC-9) • **FR** Toute plaque + 2 brûleurs sur Four à chaleur tournante électrique cm. 55x36x34h, temp: 50÷300°C, avec 1 grille cm.53x32,5 GN1/1 - Plaque cm. 79x73 - Element neutre avec porte (inclus 1 Élément de jonction top mod.TPC-9) • **ES** Placa de cocción + 2 fuegos sobre Horno eléctrico ventilado cm. 55x36x34h, temp: 50÷300°C, con 1 parilla cm.53x32,5 GN1/1 - Placa cm 79x73 - Armario neutro con puerta (incluida 1 Chapa de cierre para top mod.TPC-9)
cm. 120x 90x 90h

⚡ 29 kW
24.940 kcal/h

7.642,00
250 / 1,32

⚡ 5,32 kW
400V~3N
230V~3
50/60 Hz

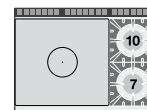

TUTTAPIASTRA A GAS CON FORNO

MOD. _____
COD. _____

DESCRIZIONE/DESCRIPTION/BEZEICHNUNG/DESCRIPTION/DESCRIPCIÓN
DIMENSIONI/DIMENSIONS/ABMESSUNGEN/DIMENSIONS/DIMENSIONES

POTENZA/POWER/LEISTUNG/PUISSANCE/POTENCIA
VOLTAGGIO/VOLTAGE/SPANNUNG/VOLTAGE/VOLTAJE

⚡ 42 kW
36.080 kcal/h

PREZZO/PRICE
PREIS/PRIX/PRECIO
KG / M³



TPF2-912G
09701250

TUTTA PIASTRA + 2 FUOCHI SU FORNO GAS STATICO
CM. 107X73X34H, TEMP: 150÷300°C, CON 1 GRIGLIA
CM.105X71 - PIASTRA CM 79X73 (INCLUSA 1 TESTATA
CHIUSURA PIANO MOD.TPC-9)

EN Solid top + 2 burners Traditional gas-oven cm. 107x73x34h, temp: 150÷300°C, with 1 grid cm.105x71 - Plate 79x73 (included 1 Head end filler strip mod.TPC-9) • **DE** Kochplatte + 2 Gaskochstellen auf Statischer Gas-Backofen cm. 107x73x34h, temp: 150÷300°C, mit 1 Rost cm.105x71 - Platte 79x73 (inbegriffen 1 Abschluss-Element mod.TPC-9) • **FR** Toute plaque + 2 brûleurs sur Four à gaz statique cm. 107x73x34h, temp: 150÷300°C, avec 1 grille cm.105x71 - Plaque cm. 79x73 (inclus 1 Élément de jonction top mod.TPC-9) • **ES** Placa de cocción + 2 fuegos sobre Horno a gas estático cm. 107x73x34h, temp: 150÷300°C, con 1 parilla cm.105x71 - Placa cm 79x73 (incluida 1 Chapa de cierre para top mod.TPC-9)
cm. 120x 90x 90h



⚡ 42 kW
36.080 kcal/h

7.439,00
264 / 1,32

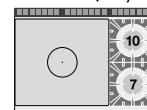

TPF2-912GE
09711260

TUTTA PIASTRA + 2 FUOCHI SU FORNO ELETTRICO STATICO
CM. 107X73X34H, TEMP: 50÷300°C, CON 1 GRIGLIA
CM.105X71 - PIASTRA CM 79X73 (INCLUSA 1 TESTATA
CHIUSURA PIANO MOD.TPC-9)

EN Solid top + 2 burners traditional electric oven cm. 107x73x34h, temp: 50÷300°C, with 1 grid cm.105x71 - Plate 79x73 (included 1 Head end filler strip mod.TPC-9) • **DE** Kochplatte + 2 Gaskochstellen auf Statischer Elektro-Backofen cm. 107x73x34h, temp: 50÷300°C, mit 1 Rost cm.105x71 - Platte 79x73 (inbegriffen 1 Abschluss-Element mod.TPC-9) • **FR** Toute plaque + 2 brûleurs sur Four électrique statique cm. 107x73x34h, temp: 50÷300°C, avec 1 grille cm.105x71 - Plaque cm. 79x73 (inclus 1 Élément de jonction top mod.TPC-9) • **ES** Placa de cocción + 2 fuegos sobre Horno eléctrico estático cm. 107x73x34h, temp: 50÷300°C, con 1 parilla cm.105x71 - Placa cm 79x73 (incluida 1 Chapa de cierre para top mod.TPC-9)
cm. 120x 90x 90h



⚡ 29 kW
24.940 kcal/h

7.581,00
260 / 1,32

⚡ 9,2 kW
400V~3N
50/60 Hz

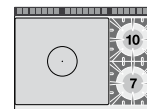

TPF4-912GV
09721251

TUTTA PIASTRA + 4 FUOCHI SU FORNO GAS STATICO
CM. 67X73X34H, TEMP: 150÷300°C, CON 1 GRIGLIA
CM.65X71 GN2/1 - PIASTRA CM 39X73 - VANO NEUTRO CON PORTA
(INCLUSA 1 TESTATA CHIUSURA PIANO MOD.TPC-9)

EN Solid top + 4 burners Traditional gas-oven cm. 67x73x34h, temp: 150÷300°C, with 1 grid cm.65x71 GN2/1 - Plate 39x73 cm - Neutral cabinet with door (included 1 Head end filler strip mod.TPC-9) • **DE** Kochplatte + 4 Gaskochstellen auf Statischer Gas-Backofen cm. 67x73x34h, temp: 150÷300°C, mit 1 Rost cm.65x71 GN2/1 - Platte 39x73 cm - Neutrales Schrankelement mit Tür (inbegriffen 1 Abschluss-Element mod.TPC-9) • **FR** Toute plaque + 4 brûleurs sur Four à gaz statique cm. 67x73x34h, temp: 150÷300°C, avec 1 grille cm.65x71 GN2/1 - Plaque cm. 39x73 - Element neutre avec porte (inclus 1 Élément de jonction top mod.TPC-9) • **ES** Placa de cocción + 4 fuegos sobre Horno a gas estático cm. 67x73x34h, temp: 150÷300°C, con 1 parilla cm.65x71 GN2/1 - Placa cm 39x73 - Armario neutro con puerta (incluida 1 Chapa de cierre para top mod.TPC-9)
cm. 120x 90x 90h



⚡ 43,5 kW
37.410 kcal/h

7.193,00
249 / 1,32

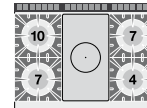

TPF4-912GEV
09731261

TUTTA PIASTRA + 4 FUOCHI SU FORNO ELETTRICO STATICO
CM. 67X73X34H, TEMP: 50÷300°C, CON 1 GRIGLIA
CM.65X71 GN2/1 - PIASTRA CM 39X73 - VANO NEUTRO
CON PORTA (INCLUSA 1 TESTATA CHIUSURA PIANO MOD.
TPC-9)

EN Solid top + 4 burners traditional electric oven cm. 67x73x34h, temp: 50÷300°C, with 1 grid cm.65x71 GN2/1 - Plate 39x73 cm - Neutral cabinet with door (included 1 Head end filler strip mod.TPC-9) • **DE** Kochplatte + 4 Gaskochstellen auf Statischer Elektro-Backofen cm. 67x73x34h, temp: 50÷300°C, mit 1 Rost cm.65x71 GN2/1 - Platte 39x73 cm - Neutrales Schrankelement mit Tür (inbegriffen 1 Abschluss-Element mod.TPC-9) • **FR** Toute plaque + 4 brûleurs sur Four électrique statique cm. 67x73x34h, temp: 50÷300°C, avec 1 grille cm.65x71 GN2/1 - Plaque cm. 39x73 - Element neutre avec porte (inclus 1 Élément de jonction top mod.TPC-9) • **ES** Placa de cocción + 4 fuegos sobre Horno eléctrico estático cm. 67x73x34h, temp: 50÷300°C, con 1 parilla cm.65x71 GN2/1 - Placa cm 39x73 - Armario neutro con puerta (incluida 1 Chapa de cierre para top mod.TPC-9)
cm. 120x 90x 90h



⚡ 35 kW
30.100 kcal/h

7.300,00
245 / 1,32

⚡ 6,7 kW
400V~3N
50/60 Hz

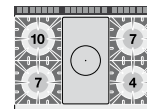

TUTTAPIASTRA A GAS CON FORNO ELETTRICO

MOD. _____
COD. _____

DESCRIZIONE/DESCRIPTION/BEZEICHNUNG/DESCRIPTION/DESCRIPCIÓN
DIMENSIONI/DIMENSIONS/ABMESSUNGEN/DIMENSIONS/DIMENSIONES

POTENZA/POWER/LEISTUNG/PUISSANCE/POTENCIA
VOLTAGGIO/VOLTAGE/SPANNUNG/VOLTAGE/VOLTAJE

⚡ kW _____
kcal/h _____
V~ _____
Hz _____

PREZZO/PRICE
PREIS/PRIX/PRECIO
KG / M³



TPFV4-912GEV
09731266

TUTTA PIASTRA + 4 FUOCHI SU FORNO ELETTRICO VENTILATO CM. 55X36X34H, TEMP: 50÷300°C, CON 1 GRIGLIA CM.53X32,5 GN1/1 - PIASTRA CM 39X73 - VANO NEUTRO CON PORTA (INCLUSA 1 TESTATA CHIUSURA PIANO MOD.TPC-9)

EN Solid top + 4 burners electric fan oven cm. 55x36x34h, temp: 50÷300°C, with 1 grid cm.53x32,5 GN1/1 - Plate 39x73 cm - Neutral cabinet with door (included 1 Head end filler strip mod.TPC-9) • **DE** Kochplatte + 4 Gaskochstellen - Elektro-Heißluftofen cm. 55x36x34h, temp: 50÷300°C, mit 1 Rost cm.53x32,5 GN1/1 - Platte 39x73 cm - Neutrales Schrankelement mit Tür (inbegriffen 1 Abschluss-Element mod.TPC-9) • **FR** Toute plaque + 4 brûleurs sur Four à chaleur tournante électrique cm. 55x36x34h, temp: 50÷300°C, avec 1 grille cm.53x32,5 GN1/1 - Plaque cm. 39x73 - Element neutre avec porte (inclus 1 Élément de jonction top mod.TPC-9) • **ES** Placa de cocción + 4 fuegos sobre Horno eléctrico ventilado cm. 55x36x34h, temp: 50÷300°C, con 1 parilla cm.53x32,5 GN1/1 - Placa cm 39x73 - Armario neutro con puerta (incluida 1 Chapa de cierre para top mod.TPC-9)
cm. 120x 90x 90h



⚡ 35 kW _____ **7.740,00**
30.100 kcal/h 245 / 1,32

⚡ 5,32 kW _____
400V~3N
230V~3
50/60 Hz

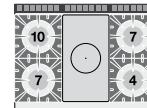

TPF4-912G
09721250

TUTTA PIASTRA + 4 FUOCHI SU FORNO GAS STATICO CM. 107X73X34H, TEMP: 150÷300°C, CON 1 GRIGLIA CM.105X71 - PIASTRA CM 39X73 (INCLUSA 1 TESTATA CHIUSURA PIANO MOD.TPC-9)

EN Solid top + 4 burners Traditional gas-oven cm. 107x73x34h, temp: 150÷300°C, with 1 grid cm.105x71 - Plate 39x73 cm (included 1 Head end filler strip mod.TPC-9) • **DE** Kochplatte + 4 Gaskochstellen auf Statischer Gas-Backofen cm. 107x73x34h, temp: 150÷300°C, mit 1 Rost cm.105x71 - Platte 39x73 cm (inbegriffen 1 Abschluss-Element mod.TPC-9) • **FR** Toute plaque + 4 brûleurs sur Four à gaz statique cm. 107x73x34h, temp: 150÷300°C, avec 1 grille cm.105x71 - Plaque cm. 39x73 (inclus 1 Élément de jonction top mod.TPC-9) • **ES** Placa de cocción + 4 fuegos sobre Horno a gas estático cm. 107x73x34h, temp: 150÷300°C, con 1 parilla cm.105x71 - Placa cm 39x73 (incluida 1 Chapa de cierre para top mod.TPC-9)
cm. 120x 90x 90h



⚡ 48 kW _____ **7.642,00**
41.280 kcal/h 259 / 1,32

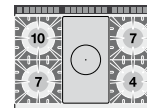

TPF4-912GE
09731260

TUTTA PIASTRA + 4 FUOCHI SU FORNO ELETTRICO STATICO CM. 107X73X34H, TEMP: 50÷300°C, CON 1 GRIGLIA CM.105X71 - PIASTRA CM 39X73 (INCLUSA 1 TESTATA CHIUSURA PIANO MOD.TPC-9)

EN Solid top + 4 burners traditional electric oven cm. 107x73x34h, temp: 50÷300°C, with 1 grid cm.105x71 - Plate 39x73 cm (included 1 Head end filler strip mod.TPC-9) • **DE** Kochplatte + 4 Gaskochstellen auf Statischer Elektro-Backofen cm. 107x73x34h, temp: 50÷300°C, mit 1 Rost cm.105x71 - Platte 39x73 cm (inbegriffen 1 Abschluss-Element mod.TPC-9) • **FR** Toute plaque + 4 brûleurs sur Four électrique statique cm. 107x73x34h, temp: 50÷300°C, avec 1 grille cm.105x71 - Plaque cm. 39x73 (inclus 1 Élément de jonction top mod.TPC-9) • **ES** Placa de cocción + 4 fuegos sobre Horno eléctrico estático cm. 107x73x34h, temp: 50÷300°C, con 1 parilla cm.105x71 - Placa cm 39x73 (incluida 1 Chapa de cierre para top mod.TPC-9)
cm. 120x 90x 90h



⚡ 35 kW _____ **7.780,00**
30.100 kcal/h 255 / 1,32

⚡ 9,2 kW _____
400V~3N
50/60 Hz

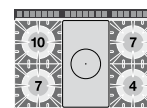

BM-94EM
09050410

BAGNOMARIA MONOFASE SU MOBILE A GIORNO VASCA PER GN 1/1 + GN 1/3 H. 15 RUBINETTO CARICO ACQUA, SCARICO A PAVIMENTO (INCLUSA 1 TESTATA CHIUSURA PIANO MOD.TPA-9)

EN Bain-marie singlephase on open cabinet - Bowl for GN 1/1 + GN 1/3 h.15 - Water loading top floor draining (included 1 Head end filler strip mod.TPA-9) • **DE** Wasserbäder einphasig mit Offenem Unterbau - Becken GN 1/1 + GN 1/3 h.15 - Wasserlauf-Hahn, Ablauf am Boden (inbegriffen 1 Abschluss-Element mod.TPA-9) • **FR** Bain marie monophasé sur armoire ouvert Cuve GN 1/1 + GN 1/3 h.15 Robinet d'arrivée d'eau - Système de vidange au sol (inclus 1 Élément de jonction top mod.TPA-9) • **ES** Baño de maría monofásico sobre mueble abierto Cuba para GN 1/1 + GN 1/3 15h Grifo carga agua, descarga a pavimento (incluida 1 Chapa de cierre para top mod.TPA-9)
cm. 40x 90x 90h



⚡ 2,85 KW _____ **2.265,00**
230V~ _____ 52 / 0,46
50/60 Hz

BAGNOMARIA ELETTRICI

MOD. _____
COD. _____

DESCRIZIONE/DESCRIPTION/BEZEICHNUNG/DESCRIPTION/DESCRIPCIÓN
DIMENSIONI/DIMENSIONS/ABMESSUNGEN/DIMENSIONS/DIMENSIONES

POTENZA/POWER/LEISTUNG/PUISSANCE/POTENCIA
VOLTAGGIO/VOLTAGE/SPANNUNG/VOLTAGE/VOLTAJE

⚡ kW
kcal/h

PREZZO/PRICE
PREIS/PRIX/PRECIO
KG / M³



BM-98ET
09050830

BAGNOMARIA TRIFASE SU MOBILE A GIORNO - VASCA PER GN 2/1 + 2 X GN 1/3 15H RUBINETTO CARICO ACQUA + SCARICO A PAVIMENTO (INCLUSA 1 TESTATA CHIUSURA PIANO MOD.TPA-9)

EN Bain-marie threephase on open cabinet - Bowl for GN 2/1 + 2 x GN 1/3 15h - Floor draining (included 1 Head end filler strip mod.TPA-9) • **DE** Wasserbäder dreiphasig mit offenem Unterbau - Becken GN 2/1 + 2 x GN 1/3 15h - Ablauf am Boden (inbegriffen 1 Abschluss-Element mod.TPA-9) • **FR** Bain marie triphase sur armoire ouvert - Cuve GN 2/1 + 2 x GN 1/3 15h - Système de vidange au sol (inclus 1 Élément de jonction top mod.TPA-9) • **ES** Baño de maría trifásico sobre mueble abierto Cuba para GN 2/1 + 2 x GN 1/3 h.15 - Descarga a pavimento (incluida 1 Chapa de cierre para top mod.TPA-9)
cm. 80x 90x 90h



⚡ 5,7 kW
400V~3N
230V~3
50/60 Hz

3.057,00
76 / 0,89

BM-94G
09220450

BAGNOMARIA GAS SU MOBILE A GIORNO VASCA PER GN 1/1 + GN 1/3 H.15 RUBINETTO CARICO ACQUA, SCARICO A PAVIMENTO (INCLUSA 1 TESTATA CHIUSURA PIANO MOD. TPA-9)

EN Gas bain-marie on open cabinet - Bowl for GN 1/1 + GN 1/3 h.15 - Water loading tap and floor draining (included 1 Head end filler strip mod.TPA-9) • **DE** Gas Wasserbad mit offenem Unterbau - Becken GN 1/1 + GN 1/3 h.15 - Wasserlauf-Hahn, Ablauf am Boden (inbegriffen 1 Abschluss-Element mod.TPA-9) • **FR** Bain-marie gaz sur armoire ouvert Cuve pour GN 1/1 + GN 1/3 h.15 Robinet d'arrivée d'eau, système de vidange au sol (inclus 1 Élément de jonction top mod.TPA-9) • **ES** Baño de maría gas sobre mueble abierto Cuba para GN 1/1 + GN 1/3 h.15 Grifo carga agua, descarga a pavimento (incluida 1 Chapa de cierre para top mod.TPA-9)
cm. 40x 90x 90h



⚡ 3,5 kW
3.010 kcal/h

2.452,00
56 / 0,46

BM-98G
09220850

BAGNOMARIA GAS SU MOBILE A GIORNO VASCA PER GN 2/1 + 2 X GN 1/3 H.15 RUBINETTO CARICO ACQUA, SCARICO A PAVIMENTO (INCLUSA 1 TESTATA CHIUSURA PIANO MOD.TPA-9)

EN Gas bain-marie on open cabinet - Bowl for GN 2/1 + 2 x GN 1/3 h.15 - Water loading tap and floor draining (included 1 Head end filler strip mod.TPA-9) • **DE** Gas Wasserbad mit offenem Unterbau - Becken GN 2/1 + 2 x GN 1/3 h.15 - Wasserlauf-Hahn, Ablauf am Boden (inbegriffen 1 Abschluss-Element mod.TPA-9) • **FR** Bain-marie gaz sur armoire ouvert Cuve pour GN 2/1 + 2 x GN 1/3 h.15 Robinet d'arrivée d'eau, système de vidange au sol (inclus 1 Élément de jonction top mod.TPA-9) • **ES** Baño de maría gas sobre mueble abierto Cuba para GN 2/1 + 2 x GN 1/3 h.15 Grifo carga agua, descarga a pavimento (incluida 1 Chapa de cierre para top mod.TPA-9)
cm. 80x 90x 90h



⚡ 6,5 kW
5.590 kcal/h

3.548,00
81 / 0,89

BS-94EM
09040410

CONTENITORE CALDO CON INFRAROSSO, MONOFASE SU MOBILE A GIORNO VASCA CM. 30,5X51X16,5H CON FALSO FONDO FORATO (INCLUSA 1 TESTATA CHIUSURA PIANO MOD.TPA-9)

EN Fry dump singlephase with infra-red heater on open cabinet. Bowl cm. 30,5x51x16,5h with perforated double bottom (included 1 Head end filler strip mod.TPA-9) • **DE** Frittenwanne Einphasig mit Infrarotstrahler mit offenem Unterbau. Becke cm. 30,5x51x16,5h mit gelochtem Bodenrost (inbegriffen 1 Abschluss-Element mod.TPA-9) • **FR** Silo a frites monophasé avec infrarouge sur armoire ouvert. Cuve cm 30,5x51x16,5h avec double-fond perforé. (inclus 1 Élément de jonction top mod.TPA-9) • **ES** Contenedor caliente por infrarrojo, monofásico y sobre mueble abierto. Cuba cm. 30,5x51x16,5h con falso fondo agujereado (incluida 1 Chapa de cierre para top mod.TPA-9)
cm. 40x 90x 90h



⚡ 1,47 kW
230V~
50/60 Hz

2.329,00
60 / 0,46

MOD. _____
COD. _____

DESCRIZIONE/DESCRIPTION/BEZEICHNUNG/DESCRIPTION/DESCRIPCIÓN
DIMENSIONI/DIMENSIONS/ABMESSUNGEN/DIMENSIONS/DIMENSIONES

POTENZA/POWER/LEISTUNG/PUISSANCE/POTENCIA
VOLTAGGIO/VOLTAGE/SPANNUNG/VOLTAGE/VOLTAJE

⚡ kcal/h ⚡ kW
V~
Hz

PREZZO/PRICE
PREIS/PRIX/PRECIO
KG / M³



CP-94ET
09100430

CUOCIPASTA TRIFASE LT. 40 VASCA CM. 30,7X50,9X32,7H. RUBINETTO CARICO ACQUA, SFIORATORE + SCARICO A PAVIMENTO (CESTI ESCLUSI) (INCLUSA 1 TESTATA CHIUSURA PIANO MOD.TPA-9)

EN Pasta cooker threephase 40 lts. Tank cm. 30,7x50,9x32,7h. Water loading tap + overflow device and floor draining (BASKETS EXCLUDED) (included 1 Head end filler strip mod.TPA-9) • **DE** Nudelkocher dreiphasig lt. 40 - Becken cm. 30,7x50,9x32,7h. Wasserlauf-Hahn + Überlauf-Vorrichtung und Ablauf am Boden (KORB AUSGESCHLOSSEN) (inbegriffen 1 Abschluss-Element mod.TPA-9) • **FR** Cuiseur a pates triphase lt. 40 Cuve cm.30,7x50,9x32,7h. Robinet d'arrivée d'eau trop plein + système de vidange au sol (PANIERS EXCLUS) (inclus 1 Élément de jonction top mod.TPA-9) • **ES** Cuece pasta trifásico lt. 40 - Cuba cm. 30,7x50,9x32,7h. Grifo carga agua + vertedero + descarga a pavimento (CESTAS EXCLUIDAS) (incluida 1 Chapa de cierre para top mod.TPA-9)
cm. 40x 90x 90h



⚡ 13,5 kW **3.539,00**
400V~3N 57 / 0,46
50/60 Hz

COMBINAZIONI

- Combinations / • Zusammenstellungen
- Combinaisons / • Combinación múltiple

1/1	1/2	1/3	1/3	1/6 1/6	1/6 1/6
	1/2	1/3	2/3	1/3	1/6 1/6
		1/3		1/3	1/6 1/6

CPA-94ET
09100435

CUOCIPASTA TRIFASE LT. 40 VASCA CM. 30,7X50,9X32,7H. CARICO ACQUA AUTOMATICO CON SENSORE DI LIVELLO - SFIORATORE + SCARICO A PAVIMENTO (CESTI ESCLUSI) (INCLUSA 1 TESTATA CHIUSURA PIANO MOD.TPA-9)

EN Pasta cooker threephase 40 lts. Tank cm. 30,7x50,9x32,7h. Automatic Water loading with level sensor - overflow device and floor draining (BASKETS EXCLUDED) (included 1 Head end filler strip mod.TPA-9) • **DE** Nudelkocher dreiphasig lt. 40 - Becken cm. 30,7x50,9x32,7h. Automatische Wasser Beladung mit Niveauregulierung + Überlauf-Vorrichtung und Ablauf am Boden (KORB AUSGESCHLOSSEN) (inbegriffen 1 Abschluss-Element mod.TPA-9) • **FR** Cuiseur a pates triphase lt. 40 Cuve cm.30,7x50,9x32,7h. Chargement automatique de l'eau avec sensor de niveau, trop plein Système de vidange au sol (PANIERS EXCLUS) (inclus 1 Élément de jonction top mod.TPA-9) • **ES** Cuece pasta trifásico lt. 40 - Cuba cm. 30,7x50,9x32,7h. Carga automática de agua con sensor de nivel + vertedero + descarga a pavimento. (CESTAS EXCLUIDAS) (incluida 1 Chapa de cierre para top mod.TPA-9)
cm. 40x 90x 90h



⚡ 13,5 kW **3.997,00**
400V~3N 57 / 0,46
50/60 Hz

COMBINAZIONI

- Combinations / • Zusammenstellungen
- Combinaisons / • Combinación múltiple

1/1	1/2	1/3	1/3	1/6 1/6	1/6 1/6
	1/2	1/3	2/3	1/3	1/6 1/6
		1/3		1/3	1/6 1/6

CUOCIPASTA ELETTRICI

MOD. _____
COD. _____

DESCRIZIONE/DESCRIPTION/BEZEICHNUNG/DESCRIPTION/DESCRIPCIÓN
DIMENSIONI/DIMENSIONS/ABMESSUNGEN/DIMENSIONS/DIMENSIONES

POTENZA/POWER/LEISTUNG/PUISSANCE/POTENCIA
VOLTAGGIO/VOLTAGE/SPANNUNG/VOLTAGE/VOLTAJE

⚡ kW
kcal/h

⚡ kw
V~
Hz

PREZZO/PRICE
PREIS/PRIX/PRECIO
KG / M³



CP-98ET
09100830

CUOCIPASTA TRIFASE LT. 40+40 2 VASCHE CM. 30,7X50,9X32,7H. RUBINETTO CARICO ACQUA, SFIORATORE + SCARICO A PAVIMENTO (CESTI ESCLUSI) (INCLUSA 1 TESTATA CHIUSURA PIANO MOD.TPA-9)

EN Pasta cooker threephase 40+40 lts. 2 Tanks cm. 30,7x50,9x32,7h. Water loading tap + overflow device and floor draining (BASKETS EXCLUDED) (included 1 Head end filler strip mod.TPA-9) • **DE** Nudelkocher dreiphasig lt. 40+40 2 Becken cm. 30,7x50,9x32,7h. Wasserlauf-Hahn + Überlauf-Vorrichtung und Ablauf am Boden (KORB AUSGESCHLOSSEN) (inbegriffen 1 Abschluss-Element mod.TPA-9) • **FR** Cuiseur a pates triphase lt. 40+40 2 Cuves cm.30,7x50,9x32,7h. Robinet d'arrivée d'eau trop plein + système de vidange au sol (PANIERS EXCLUS) (inclus 1 Élément de jonction top mod.TPA-9) • **ES** Cuece pasta trifásico 40+40 lt. 2 Cubas cm. 30,7x50,9x32,7h. Grifo carga agua + vertedero + descarga a pavimento (CESTAS EXCLUIDAS) (incluida 1 Chapa de cierre para top mod.TPA-9)
cm. 80x 90x 90h



⚡ 27 kW
400V~3N
50/60 Hz

5.911,00
98 / 0,89

COMBINAZIONI

- Combinations / • Zusammenstellungen
- Combinaisons / • Combinación múltiple

1/1	1/2	1/3	1/3	1/6 1/6	1/6 1/6
	1/2	1/3	2/3	1/3	1/6 1/6
		1/3		1/3	1/6 1/6

CPA-98ET
09100835

CUOCIPASTA TRIFASE LT. 40+40 2 VASCHE CM. 30,7X50,9X32,7H. CARICO ACQUA AUTOMATICO CON SENSORE DI LIVELLO - SFIORATORE + SCARICO A PAVIMENTO (CESTI ESCLUSI) (INCLUSA 1 TESTATA CHIUSURA PIANO MOD.TPA-9)

EN Pasta cooker threephase 40+40 lts. 2 Tanks cm. 30,7x50,9x32,7h. Automatic Water loading with level sensor - overflow device and floor draining (BASKETS EXCLUDED) (included 1 Head end filler strip mod.TPA-9) • **DE** Nudelkocher dreiphasig lt. 40+40 2 Becken cm. 30,7x50,9x32,7h. Automatische Wasser Beladung mit Niveauregulierung + Überlauf-Vorrichtung und Ablauf am Boden (KORB AUSGESCHLOSSEN) (inbegriffen 1 Abschluss-Element mod.TPA-9) • **FR** Cuiseur a pates triphase lt. 40+40 2 Cuves cm.30,7x50,9x32,7h. Chargement automatique de l'eau avec sensor de niveau, trop plein Système de vidange au sol (PANIERS EXCLUS) (inclus 1 Élément de jonction top mod.TPA-9) • **ES** Cuece pasta trifásico 40+40 lt. 2 Cubas cm. 30,7x50,9x32,7h. Carga automática de agua con sensor de nivel + vertedero + descarga a pavimento. (CESTAS EXCLUIDAS) (incluida 1 Chapa de cierre para top mod.TPA-9)
cm. 80x 90x 90h



⚡ 27 kW
400V~3N
50/60 Hz

6.831,00
98 / 0,89

COMBINAZIONI

- Combinations / • Zusammenstellungen
- Combinaisons / • Combinación múltiple

1/1	1/2	1/3	1/3	1/6 1/6	1/6 1/6
	1/2	1/3	2/3	1/3	1/6 1/6
		1/3		1/3	1/6 1/6

CUOCIPASTA ELETTRICI

MOD. _____
COD. _____

DESCRIZIONE/DESCRIPTION/BEZEICHNUNG/DESCRIPTION/DESCRIPCIÓN
DIMENSIONI/DIMENSIONS/ABMESSUNGEN/DIMENSIONS/DIMENSIONES

POTENZA/POWER/LEISTUNG/PUISSANCE/POTENCIA
VOLTAGGIO/VOLTAGE/SPANNUNG/VOLTAGE/VOLTAJE

⚡ kW
kcal/h

⚡ kw
V~
Hz

PREZZO/PRICE
PREIS/PRIX/PRECIO
KG / M³



CPB-98ET
09100831

**CUOCIPASTA TRIFASE LT. 80 VASCA CM. 62X50,9X32,7H.
RUBINETTO CARICO ACQUA, SFIORATORE + SCARICO A
PAVIMENTO (CESTI ESCLUSI) (INCLUSA 1 TESTATA CHIUSURA
PIANO MOD.TPA-9)**

EN Pasta cooker threephase 80 lts. - Tank cm. 62x50,9x32,7h. Water loading tap + overflow device and floor draining (BASKETS EXCLUDED) (included 1 Head end filler strip mod.TPA-9) • **DE** Nudelkocher dreiphasig lt. 80 - Becken cm. 62x50,9x32,7h. Wasserlauf-Hahn + Überlauf-Vorrichtung und Ablauf am Boden (KORB AUSGESCHLOSSEN) (inbegriffen 1 Abschluss-Element mod.TPA-9) • **FR** Cuiseur a pates triphase lt. 80 - Cuve cm. 62x50,9x32,7h. Robinet d'arrivée d'eau trop plein + système de vidange au sol (PANIERS EXCLUS) (inclus 1 Elément de jonction top mod.TPA-9) • **ES** Cuece pasta trifásico lt. 80 - Cuba cm. 62x50,9x32,7h. Grifo carga agua + vertedero + descarga a pavimento (CESTAS EXCLUIDAS) (incluida 1 Chapa de cierre para top mod.TPA-9)
cm. 80x 90x 90h



⚡ 27 kW
400V~3N
50/60 Hz

5.387,00
93 / 0,89

COMBINAZIONI

- Combinations / • Zusammenstellungen
- Combinaisons / • Combinación múltiple

1/1	1/2	1/3	1/3	1/6 1/6	1/6 1/6
	1/2	1/3	2/3	1/3	1/6 1/6
		1/3		1/3	1/6 1/6

CP-94G
09270450

**CUOCIPASTA GAS LT. 40 VASCA CM. 30,7X50,9X32,7H.
RUBINETTO CARICO ACQUA, SFIORATORE + SCARICO A
PAVIMENTO (CESTI ESCLUSI) (INCLUSA 1 TESTATA CHIUSURA
PIANO MOD.TPA-9)**

EN Gas pasta cooker 40 lts. - Tank cm. 30,7x50,9x32,7h. Water loading tap + overflow device and floor draining (BASKETS EXCLUDED) (included 1 Head end filler strip mod.TPA-9) • **DE** Gas-Nudelkocher lt. 40 - Becken cm. 30,7x50,9x32,7h. Wasserlauf-Hahn + Überlauf-Vorrichtung und Ablauf am Boden (KORB AUSGESCHLOSSEN) (inbegriffen 1 Abschluss-Element mod.TPA-9) • **FR** Cuiseur a pates gaz lt. 40 - Cuve cm.30,7x50,9x32,7h. Robinet d'arrivée d'eau trop plein Système de vidange au sol (PANIERS EXCLUS) (inclus 1 Elément de jonction top mod.TPA-9) • **ES** Cuece pasta gas 40 lt. - Cuba cm. 30,7x50,9x32,7h. Grifo carga agua + vertedero + descarga a pavimento. (CESTAS EXCLUIDAS) (incluida 1 Chapa de cierre para top mod.TPA-9)
cm. 40x 90x 90h



⚡ 13,95 kW
11.997 kcal/h

3.707,00
68 / 0,46

⚡ 0,02 KW
230V~
50/60 Hz

COMBINAZIONI

- Combinations / • Zusammenstellungen
- Combinaisons / • Combinación múltiple

1/1	1/2	1/3	1/3	1/6 1/6	1/6 1/6
	1/2	1/3	2/3	1/3	1/6 1/6
		1/3		1/3	1/6 1/6

CUOCIPASTA A GAS

MOD. _____
COD. _____

DESCRIZIONE/DESCRIPTION/BEZEICHNUNG/DESCRIPTION/DESCRIPCIÓN
DIMENSIONI/DIMENSIONS/ABMESSUNGEN/DIMENSIONS/DIMENSIONES

POTENZA/POWER/LEISTUNG/PUISSANCE/POTENCIA
VOLTAGGIO/VOLTAGE/SPANNUNG/VOLTAGE/VOLTAJE

⚡ kW
kcal/h

⚡ kW
V~
Hz

PREZZO/PRICE
PREIS/PRIX/PRECIO
KG / M³



CPA-94G
09270455

CUOCIPASTA GAS LT. 40 VASCA CM. 30,7X50,9X32,7H. CARICO ACQUA AUTOMATICO CON SENSORE DI LIVELLO - SFIORATORE + SCARICO A PAVIMENTO (CESTI ESCLUSI) (INCLUSA 1 TESTATA CHIUSURA PIANO MOD.TPA-9)

EN Gas pasta cooker 40 lts. - Tank cm. 30,7x50,9x32,7h. Automatic Water loading with level sensor - overflow device and floor draining (BASKETS EXCLUDED) (included 1 Head end filler strip mod.TPA-9) • **DE** Gas-Nudelkocher lt. 40 - Becken cm. 30,7x50,9x32,7h. Automatische Wasser Beladung mit Niveauregulierung + Überlauf-Vorrichtung und Ablauf am Boden (KORB AUSGESCHLOSSEN) (inbegriffen 1 Abschluss-Element mod.TPA-9) • **FR** Cuiseur a pates gaz lt. 40 - Cuve cm.30,7x50,9x32,7h. Chargement automatique de l'eau avec sensor de niveau, trop plein Système de vidange au sol (PANIERS EXCLUS) (inclus 1 Elément de jonction top mod.TPA-9) • **ES** Cuece pasta gas 40 lt. - Cuba cm. 30,7x50,9x32,7h. Carga automática de agua con sensor de nivel + vertedero + descarga a pavimento. (CESTAS EXCLUIDAS) (incluida 1 Chapa de cierre para top mod.TPA-9)

cm. 40x 90x 90h



⚡ 13,95 kW
11.997 kcal/h **3.973,00**
68 / 0,46

⚡ 0,035 KW
230V~
50/60 Hz

COMBINAZIONI

- Combinations / • Zusammenstellungen
- Combinaisons / • Combinación múltiple

1/1	1/2	1/3	1/3	1/6 1/6	1/6 1/6
	1/2	1/3	2/3	1/3	1/6 1/6
		1/3		1/3	1/6 1/6

CP-98G
09270850

CUOCIPASTA GAS LT. 40+40 2 VASCHE CM. 30,7X50,9X32,7H. RUBINETTO CARICO ACQUA, SFIORATORE + SCARICO A PAVIMENTO (CESTI ESCLUSI) (INCLUSA 1 TESTATA CHIUSURA PIANO MOD.TPA-9)

EN Gas pasta cooker 40+40 lts 2 Tanks cm. 30,7x50,9x32,7h. Water loading, tap + overflow device and floor draining (BASKETS EXCLUDED) (included 1 Head end filler strip mod.TPA-9) • **DE** Gas-Nudelkocher lt. 40+40 2 Becken cm. 30,7x50,9x32,7h. Wasserlauf-Hahn, Überlauf-Vorrichtung und Ablauf am Boden (KORB AUSGESCHLOSSEN) (inbegriffen 1 Abschluss-Element mod.TPA-9) • **FR** Cuiseur a pates gaz lt. 40+40 2 Cuve cm. 30,7x50,9x32,7h. Robinet d'arrivée d'eau trop plein + système de vidange au sol (PANIERS EXCLUS) (inclus 1 Elément de jonction top mod.TPA-9) • **ES** Cuece pasta gas 40+40 lt. 2 Cubas cm. 30,7x50,9x32,7h. Grifo carga agua + vertedero + descarga a pavimento (CESTAS EXCLUIDAS) (incluida 1 Chapa de cierre para top mod.TPA-9)

cm. 80x 90x 90h



⚡ 27,9 kW
23.994 kcal/h **6.269,00**
116 / 0,89

⚡ 0,04 KW
230V~
50/60 Hz

COMBINAZIONI

- Combinations / • Zusammenstellungen
- Combinaisons / • Combinación múltiple

1/1	1/2	1/3	1/3	1/6 1/6	1/6 1/6
	1/2	1/3	2/3	1/3	1/6 1/6
		1/3		1/3	1/6 1/6

CUOCIPASTA A GAS

MOD. _____
COD. _____

DESCRIZIONE/DESCRIPTION/BEZEICHNUNG/DESCRIPTION/DESCRIPCIÓN
DIMENSIONI/DIMENSIONS/ABMESSUNGEN/DIMENSIONS/DIMENSIONES

POTENZA/POWER/LEISTUNG/PUISSANCE/POTENCIA
VOLTAGGIO/VOLTAGE/SPANNUNG/VOLTAGE/VOLTAJE

⚡ kW
kcal/h

⚡ kW
V~
Hz

PREZZO/PRICE
PREIS/PRIX/PRECIO
KG / M³



CPA-98G
09270855

CUOCIPASTA GAS LT. 40+40 2 VASCHE CM. 30,7X50,9X32,7H. CARICO ACQUA AUTOMATICO CON SENSORE DI LIVELLO - SFIORATORE + SCARICO A PAVIMENTO (CESTI ESCLUSI) (INCLUSA 1 TESTATA CHIUSURA PIANO MOD.TPA-9)

EN Gas pasta cooker 40+40 lts 2 Tanks cm. 30,7x50,9x32,7h. Automatic Water loading with level sensor - overflow device and floor draining (BASKETS EXCLUDED) (included 1 Head end filler strip mod.TPA-9) • **DE** Gas-Nudelkocher lt. 40+40 2 Becken cm. 30,7x50,9x32,7h. Automatische Wasser Beladung mit Niveauregulierung + Überlauf-Vorrichtung und Ablauf am Boden (KORB AUSGESCHLOSSEN) (inbegriffen 1 Abschluss-Element mod.TPA-9) • **FR** Cuiseur a pates gaz lt. 40+40 2 Cuve cm. 30,7x50,9x32,7h. Chargement automatique de l'eau avec sensor de niveau, trop plein Système de vidange au sol (PANIERS EXCLUS) (inclus 1 Elément de jonction top mod.TPA-9) • **ES** Cuece pasta gas 40+40 lt. 2 Cubas cm. 30,7x50,9x32,7h. Carga automática de agua con sensor de nivel + vertedero + descarga a pavimento. (CESTAS EXCLUIDAS) (incluida 1 Chapa de cierre para top mod.TPA-9)

cm. 80x 90x 90h



⚡ 27,9 kW
23.994 kcal/h

6.799,00
116 / 0,89

⚡ 0,07 KW
230V~
50/60 Hz

COMBINAZIONI

- Combinations / • Zusammenstellungen
- Combinaisons / • Combinación múltiple

1/1	1/2	1/3	1/3	1/6 1/6	1/6 1/6
	1/2	1/3	2/3	1/3	1/6 1/6
		1/3		1/3	1/6 1/6

CPB-98G
09270851

CUOCIPASTA GAS LT. 80 VASCA CM. 62X50,9X32,7H. RUBINETTO CARICO ACQUA, SFIORATORE + SCARICO A PAVIMENTO (CESTI ESCLUSI) (INCLUSA 1 TESTATA CHIUSURA PIANO MOD.TPA-9)

EN Gas pasta cooker 80 lts. - Tank cm. 62x50,9x32,7h. Water loading tap + overflow device and floor draining (BASKETS EXCLUDED) (included 1 Head end filler strip mod.TPA-9) • **DE** Gas-Nudelkocher lt. 80 - Becken cm. 62x50,9x32,7h. Wasserlauf-Hahn + Überlauf-Vorrichtung und Ablauf am Boden (KORB AUSGESCHLOSSEN) (inbegriffen 1 Abschluss-Element mod.TPA-9) • **FR** Cuiseur a pates gaz lt. 80 - Cuve cm. 62x50,9x32,7h. Robinet d'arrivée d'eau trop plein + système de vidange au sol (PANIERS EXCLUS) (inclus 1 Elément de jonction top mod.TPA-9) • **ES** Cuece pasta gas 80 lt. - Cuba cm. 62x50,9x32,7h. Grifo carga agua + vertedero + descarga a pavimento (CESTAS EXCLUIDAS) (incluida 1 Chapa de cierre para top mod.TPA-9)

cm. 80x 90x 90h



⚡ 31,5 kW
27.060 kcal/h

5.530,00
110 / 0,89

⚡ 0,02 KW
230V~
50/60 Hz

COMBINAZIONI

- Combinations / • Zusammenstellungen
- Combinaisons / • Combinación múltiple

1/1	1/2	1/3	1/3	1/6 1/6	1/6 1/6
	1/2	1/3	2/3	1/3	1/6 1/6
		1/3		1/3	1/6 1/6

CUOCIPASTA A GAS POTENZIATO

MOD. _____
COD. _____

DESCRIZIONE/DESCRIPTION/BEZEICHNUNG/DESCRIPTION/DESCRIPCIÓN
DIMENSIONI/DIMENSIONS/ABMESSUNGEN/DIMENSIONS/DIMENSIONES

POTENZA/POWER/LEISTUNG/PUISSANCE/POTENCIA
VOLTAGGIO/VOLTAGE/SPANNUNG/VOLTAGE/VOLTAJE

⚡ kW kcal/h
⚡ kW V~ Hz

PREZZO/PRICE
PREIS/PRIX/PRECIO
KG / M³



CPP-94G
09270452

CUOCIPASTA GAS POTENZIATO LT. 40 VASCA CM. 30,7X50,9X32,7H. RUBINETTO CARICO ACQUA, SFIORATORE + SCARICO A PAVIMENTO (CESTI ESCLUSI) (INCLUDE ENTRAMBE LE TESTATE CHIUSURA PIANO)

EN Powerfull Gas pasta cooker 40 lts. - Tank cm. 30,7x50,9x32,7h. Water loading tap + overflow device and floor draining (BASKETS EXCLUDED) (included both Heads end filler strip) • **DE** Gas-Nudelkocher leistungsfähiges lt. 40 - Becken cm. 30,7x50,9x32,7h. Wasserlauf-Hahn + Überlauf-Vorrichtung und Ablauf am Boden (KORB AUSGESCHLOSSEN) (inbegriffen alle 2 Abschluss-Element) • **FR** Cuiseur a pates gaz plus puissants lt. 40 - Cuve cm.30,7x50,9x32,7h. Robinet d'arrivée d'eau trop plein Système de vidange au sol (PANIERS EXCLUS) (inclus tous 2 Elément de jonction top) • **ES** Cucece pasta gas con mayor potencia 40 lt. - Cuba cm. 30,7x50,9x32,7h. Grifo carga agua + vertedero + descarga a pavimento. (CESTAS EXCLUIDAS) (incluidas todas las 2 Chapa de cierre para top)

cm. 40x 90x 90h



⚡ 23,5 kW 4.208,00
20.210 kcal/h 69 / 0,54

⚡ 0,02 KW
230V~
50/60 Hz

COMBINAZIONI

- Combinations / • Zusammenstellungen
- Combinaisons / • Combinación múltiple

1/1	1/2	1/3	1/3	1/6 1/6	1/6 1/6
	1/2	1/3	2/3	1/3	1/6 1/6
		1/3		1/3	1/6 1/6

CPPA-94G
09270457

CUOCIPASTA GAS POTENZIATO LT. 40 VASCA CM. 30,7X50,9X32,7H. CARICO ACQUA AUTOMATICO CON SENSORE DI LIVELLO - SFIORATORE + SCARICO A PAVIMENTO (CESTI ESCLUSI) (INCLUDE ENTRAMBE LE TESTATE CHIUSURA PIANO)

EN Powerfull Gas pasta cooker 40 lts. - Tank cm. 30,7x50,9x32,7h. Automatic Water loading with level sensor - overflow device and floor draining (BASKETS EXCLUDED) (included both Heads end filler strip) • **DE** Gas-Nudelkocher leistungsfähiges lt. 40 - Becken cm. 30,7x50,9x32,7h. Automatische Wasser Beladung mit Niveauregulierung + Überlauf-Vorrichtung und Ablauf am Boden (KORB AUSGESCHLOSSEN) (inbegriffen alle 2 Abschluss-Element) • **FR** Cuiseur a pates gaz plus puissants lt. 40 - Cuve cm.30,7x50,9x32,7h. Chargement automatique de l'eau avec sensor de niveau, trop plein Système de vidange au sol (PANIERS EXCLUS) (inclus tous 2 Elément de jonction top) • **ES** Cucece pasta gas con mayor potencia 40 lt. - Cuba cm. 30,7x50,9x32,7h. Carga automática de agua con sensor de nivel + vertedero + descarga a pavimento. (CESTAS EXCLUIDAS) (incluidas todas las 2 Chapa de cierre para top)

cm. 40x 90x 90h



⚡ 23,5 kW 4.466,00
20.210 kcal/h 69 / 0,54

⚡ 0,035 KW
230V~
50/60 Hz

COMBINAZIONI

- Combinations / • Zusammenstellungen
- Combinaisons / • Combinación múltiple

1/1	1/2	1/3	1/3	1/6 1/6	1/6 1/6
	1/2	1/3	2/3	1/3	1/6 1/6
		1/3		1/3	1/6 1/6

CUOCIPASTA A GAS POTENZIATO

MOD. _____
COD. _____

DESCRIZIONE/DESCRIPTION/BEZEICHNUNG/DESCRIPTION/DESCRIPCIÓN
DIMENSIONI/DIMENSIONS/ABMESSUNGEN/DIMENSIONS/DIMENSIONES

POTENZA/POWER/LEISTUNG/PUISSANCE/POTENCIA
VOLTAGGIO/VOLTAGE/SPANNUNG/VOLTAGE/VOLTAJE

⚡ 47 kW
40.420 kcal/h

PREZZO/PRICE
PREIS/PRIX/PRECIO
KG / M³



CPP-98G
09270852

**CUOCIPASTA GAS POTENZIATO LT. 40+40 2 VASCHE
CM. 30,7X50,9X32,7H. RUBINETTO CARICO ACQUA,
SFIORATORE + SCARICO A PAVIMENTO (CESTI ESCLUSI)
(INCLUDE ENTRAMBE LE TESTATE CHIUSURA PIANO)**

EN Powerfull Gas pasta cooker 40+40 lts 2 Tanks cm. 30,7x50,9x32,7h. Water loading tap + overflow device and floor draining (BASKETS EXCLUDED) (included both Heads end filler strip) • **DE** Gas-Nudelkocher leistungsfähiges lt. 40+40 2 Becken cm. 30,7x50,9x32,7h. Wasserlauf-Hahn + Überlauf-Vorrichtung und Ablauf am Boden (KORB AUSGESCHLOSSEN) (inbegriffen alle 2 Abschluss-Element) • **FR** Cuiseur a pates gaz plus puissants lt. 40+40 2 Cuve cm.30,7x50,9x32,7h. Robinet d'arrivée d'eau trop plein Système de vidange au sol (PANIERS EXCLUS) (inclus tous 2 Elément de jonction top) • **ES** Cuece pasta gas con mayor potencia 40+40 lt. 2 Cubas cm. 30,7x50,9x32,7h. Grifo carga agua + vertedero + descarga a pavimento. (CESTAS EXCLUIDAS) (incluidas todas las 2 Chapa de cierre para top)
cm. 80x 90x 90h



⚡ 47 kW **7.649,00**
40.420 kcal/h 118 / 1,05

⚡ 0,04 KW
230V~
50/60 Hz

COMBINAZIONI

- Combinations / • Zusammenstellungen
- Combinaisons / • Combinación múltiple

1/1	1/2	1/3	1/3	1/6 1/6	1/6 1/6
	1/2	1/3	2/3	1/3	1/6 1/6
		1/3		1/3	1/6 1/6

CPPA-98G
09270857

**CUOCIPASTA GAS POTENZIATO LT. 40+40 2 VASCHE
CM. 30,7X50,9X32,7H. CARICO ACQUA AUTOMATICO
CON SENSORE DI LIVELLO - SFIORATORE + SCARICO A
PAVIMENTO (CESTI ESCLUSI) (INCLUDE ENTRAMBE LE TESTATE
CHIUSURA PIANO)**

EN Powerfull Gas pasta cooker 40+40 lts 2 Tanks cm. 30,7x50,9x32,7h. Automatic Water loading with level sensor - overflow device and floor draining (BASKETS EXCLUDED) (included both Heads end filler strip) • **DE** Gas-Nudelkocher leistungsfähiges lt. 40+40 2 Becken cm. 30,7x50,9x32,7h. Automatische Wasser Beladung mit Niveauregulierung + Überlauf-Vorrichtung und Ablauf am Boden (KORB AUSGESCHLOSSEN) (inbegriffen alle 2 Abschluss-Element) • **FR** Cuiseur a pates gaz plus puissants lt. 40+40 2 Cuve cm.30,7x50,9x32,7h. Chargement automatique de l'eau avec sensor de niveau, trop plein Système de vidange au sol (PANIERS EXCLUS) (inclus tous 2 Elément de jonction top) • **ES** Cuece pasta gas con mayor potencia 40+40 lt. 2 Cubas cm. 30,7x50,9x32,7h. Carga automática de agua con sensor de nivel + vertedero + descarga a pavimento. (CESTAS EXCLUIDAS) (incluidas todas las 2 Chapa de cierre para top)
cm. 80x 90x 90h



⚡ 47 kW **8.352,00**
40.420 kcal/h 118 / 1,05

⚡ 0,07 KW
230V~
50/60 Hz

COMBINAZIONI

- Combinations / • Zusammenstellungen
- Combinaisons / • Combinación múltiple

1/1	1/2	1/3	1/3	1/6 1/6	1/6 1/6
	1/2	1/3	2/3	1/3	1/6 1/6
		1/3		1/3	1/6 1/6

SOLLEVATORE CESTI

MOD. _____
COD. _____

DESCRIZIONE/DESCRIPTION/BEZEICHNUNG/DESCRIPTION/DESCRIPCIÓN
DIMENSIONI/DIMENSIONS/ABMESSUNGEN/DIMENSIONS/DIMENSIONES

POTENZA/POWER/LEISTUNG/PUISSANCE/POTENCIA
VOLTAGGIO/VOLTAGE/SPANNUNG/VOLTAGE/VOLTAJE

⚡ kW kcal/h
230V~
50/60 Hz

PREZZO/PRICE
PREIS/PRIX/PRECIO
KG / M³



SCCP-92EM
09140210

SOLLEVATORE CESTI DA AFFIANCARE AI CUOCIPASTA CP-94/98, SOLLEVAMENTO AUTOMATICO TEMPORIZZATO O MANUALE, 3 ASTE (INCLUSA 1 TESTATA CHIUSURA PIANO MOD.TPA-9)

EN basket elevator for pasta cooker CP-94/98, automatic timed or manual lifting, 3 rods (included 1 Head end filler strip mod.TPA-9) • **DE** heben Korbe für Nudelkocher CP-94/98, Timed oder manuelle Heben, 3 Stangen (inbegriffen 1 Abschluss-Element mod.TPA-9) • **FR** soulever des paniers pour cuiseur a pates CP-94/98, soulèvement temporisé ou manuel, 3 tiges (inclus 1 Élément de jonction top mod.TPA-9) • **ES** levantar cestas para cucece pasta CP-94/98, elevación temporizado o manual, 3 barras (incluida 1 Chapa de cierre para top mod.TPA-9)

cm. 20x 90x 90h



⚡ 0,525 KW 4.367,00
230V~ 65 / 0,46
50/60 Hz

COMBINAZIONI

- Combinations / • Zusammenstellungen
- Combinaisons / • Combinación múltiple

1/1	1/2	1/3	1/3	1/6
	1/2	1/3	2/3	1/6
		1/3		1/6

SCCPB-92EM
09140211

SOLLEVATORE CESTI DA AFFIANCARE AI CUOCIPASTA CPB-98, SOLLEVAMENTO AUTOMATICO TEMPORIZZATO O MANUALE, 3 ASTE (INCLUSA 1 TESTATA CHIUSURA PIANO MOD.TPA-9)

EN basket elevator for pasta cooker CPB-98, automatic timed or manual lifting, 3 rods (included 1 Head end filler strip mod.TPA-9) • **DE** heben Korbe für Nudelkocher CPB-98, Timed oder manuelle Heben, 3 Stangen (inbegriffen 1 Abschluss-Element mod.TPA-9) • **FR** soulever des paniers pour cuiseur a pates CPB-98, soulèvement temporisé ou manuel, 3 tiges (inclus 1 Élément de jonction top mod.TPA-9) • **ES** levantar cestas para cucece pasta CPB-98, elevación temporizado o manual, 3 barras (incluida 1 Chapa de cierre para top mod.TPA-9)

cm. 20x 90x 90h



⚡ 0,525 KW 4.367,00
230V~ 65 / 0,46
50/60 Hz

COMBINAZIONI

- Combinations / • Zusammenstellungen
- Combinaisons / • Combinación múltiple

1/1	1/2	1/3	1/3	1/6
	1/2	1/3	2/3	1/6
		1/3		1/6

PI100-98ET
09110831

PENTOLA INDIRETTA ELETTRICA LT.100 VASCA Ø CM. 60X42H (INCLUSA 1 TESTATA CHIUSURA PIANO MOD.TPA-9)

EN Electric indirect boiling pan 100 lts. Tank Ø cm. 60x42h (included 1 Head end filler strip mod.TPA-9) • **DE** Indirekter Elektro-Kochkessel lt. 100 Becken Ø cm. 60x42h (inbegriffen 1 Abschluss-Element mod.TPA-9) • **FR** Marmite indirecte électrique lt. 100 Cuve Ø cm. 60x42h (inclus 1 Élément de jonction top mod.TPA-9) • **ES** Marmita de calefacción indirecta 100 lt. Cuba Ø cm. 60x42h (incluida 1 Chapa de cierre para top mod.TPA-9)

cm. 80x 90x 90h



⚡ 16 kW 9.079,00
400V~3N 107 / 1,07
50/60 Hz

PI100A-98ET
0911A831

PENTOLA INDIRETTA ELETTRICA LT.100 VASCA Ø CM. 60X42H - CARICO AUTOMATICO INTERCAPEDINE (INCLUSA 1 TESTATA CHIUSURA PIANO MOD.TPA-9)

EN Electric indirect boiling pan 100 lts. Tank Ø cm. 60x42h - automatic water-charge of double jacket (included 1 Head end filler strip mod.TPA-9) • **DE** Indirekter Elektro-Kochkessel lt. 100 Becken Ø cm. 60x42h - automatische Wasserstandskontrolle im Zwischenmantel (inbegriffen 1 Abschluss-Element mod.TPA-9) • **FR** Marmite indirecte électrique lt. 100 Cuve Ø cm. 60x42h - remplissage automatique dans la double paroi (inclus 1 Élément de jonction top mod.TPA-9) • **ES** Marmita de calefacción indirecta 100 lt. Cuba Ø cm. 60x42h - carga automática de la camisa intercambiador (incluida 1 Chapa de cierre para top mod.TPA-9)

cm. 80x 90x 90h

⚡ 16 kW 11.322,00
400V~3N 107 / 1,07
50/60 Hz

PENTOLE ELETTRICHE

MOD. _____
COD. _____

DESCRIZIONE/DESCRIPTION/BEZEICHNUNG/DESCRIPTION/DESCRIPCIÓN
DIMENSIONI/DIMENSIONS/ABMESSUNGEN/DIMENSIONS/DIMENSIONES

POTENZA/POWER/LEISTUNG/PUISSANCE/POTENCIA
VOLTAGGIO/VOLTAGE/SPANNUNG/VOLTAGE/VOLTAJE

⚡ kW kcal/h
V~ Hz

PREZZO/PRICE
PREIS/PRIX/PRECIO
KG / M³



PIA100-98ET PENTOLA INDIRETTA ELETTRICA LT. 100 AUTOCLAVE - VASCA
09110833 **Ø CM. 60X42H (INCLUSA 1 TESTATA CHIUSURA PIANO MOD.TPA-9)**

EN Electric indirect boiling pan 100 lts. autoclave Tank Ø cm. 60x42h (included 1 Head end filler strip mod.TPA-9) • **DE** Indirekter Elektro-Kochkessel 100 lt. Druckkessel Becken Ø cm. 60x42h (inbegriffen 1 Abschluss-Element mod.TPA-9) • **FR** Marmite indirecte électrique 100 lt. autoclave Cuve Ø cm. 60x42h (inclus 1 Élément de jonction top mod.TPA-9) • **ES** Marmita de calefacción indirecta 100 lt. autoclave Cuba Ø cm. 60x42h (incluida 1 Chapa de cierre para top mod.TPA-9)
cm. 80x 90x 90h



⚡ 16 kW **10.697,00**
400V~3N 113 / 1,07
50/60 Hz

PIA100A-98ET PENTOLA INDIRETTA ELETTRICA LT. 100 AUTOCLAVE - VASCA
0911A833 **Ø CM. 60X42H - CARICO AUTOMATICO INTERCAPEDINE (INCLUSA 1 TESTATA CHIUSURA PIANO MOD.TPA-9)**

EN Electric indirect boiling pan 100 lts. autoclave Tank Ø cm. 60x42h - automatic water-charge of double jacket (included 1 Head end filler strip mod.TPA-9) • **DE** Indirekter Elektro-Kochkessel 100 lt. Druckkessel Becken Ø cm. 60x42h - automatische Wasserstandskontrolle im Zwischenmantel (inbegriffen 1 Abschluss-Element mod.TPA-9) • **FR** Marmite indirecte électrique 100 lt. autoclave Cuve Ø cm. 60x42h - remplissage automatique dans la double paroi (inclus 1 Élément de jonction top mod.TPA-9) • **ES** Marmita de calefacción indirecta 100 lt. autoclave Cuba Ø cm. 60x42h - carga automática de la camisa intercambiador (incluida 1 Chapa de cierre para top mod.TPA-9)
cm. 80x 90x 90h

⚡ 16 kW **12.940,00**
400V~3N 113 / 1,07
50/60 Hz

PD100-98G PENTOLA DIRETTA GAS LT.100 VASCA Ø CM. 60X42H
09280850 **(INCLUSA 1 TESTATA CHIUSURA PIANO MOD.TPA-9)**

EN Gas direct boiling pan 100 lts. Tank Ø cm. 60x42h (included 1 Head end filler strip mod.TPA-9) • **DE** Direkter Gas-Kochkessel 100 lt. Becken Ø cm. 60x42h (inbegriffen 1 Abschluss-Element mod.TPA-9) • **FR** Marmite directe à gaz 100 lt. Cuve Ø cm. 60x42h (inclus 1 Élément de jonction top mod.TPA-9) • **ES** Marmita de calefacción directa lt. 100 Cuba Ø cm. 60x42h (incluida 1 Chapa de cierre para top mod.TPA-9)
cm. 80x 90x 90h



⚡ 21 kW **7.104,00**
18.060 kcal/h 106 / 1,07

PDA100-98G PENTOLA DIRETTA GAS LT. 100 AUTOCLAVE VASCA Ø CM. 60X42H (INCLUSA 1 TESTATA CHIUSURA PIANO MOD.TPA-9)

09280852

EN Gas direct boiling pan 100 lts. autoclave Tank Ø cm. 60x42h (included 1 Head end filler strip mod.TPA-9) • **DE** Direkter Gas-Kochkessel 100 lt. Druckkessel Becken Ø cm. 60x42h (inbegriffen 1 Abschluss-Element mod.TPA-9) • **FR** Marmite directe à gaz 100 lt. autoclave Cuve Ø cm. 60x42h (inclus 1 Élément de jonction top mod.TPA-9) • **ES** Marmita de calefacción directa lt. 100 autoclave Cuba Ø cm. 60x42h (incluida 1 Chapa de cierre para top mod.TPA-9)
cm. 80x 90x 90h

⚡ 21 kW **8.728,00**
18.060 kcal/h 111 / 1,07

PI100-98G PENTOLA INDIRETTA GAS LT.100 VASCA Ø CM. 60X42H
09280851 **(INCLUSA 1 TESTATA CHIUSURA PIANO MOD.TPA-9)**

EN Gas indirect boiling pan 100 lts. Tank Ø cm. 60x42h (included 1 Head end filler strip mod.TPA-9) • **DE** Indirekter Gas-Kochkessel 100 lt. Becken Ø cm. 60x42h (inbegriffen 1 Abschluss-Element mod.TPA-9) • **FR** Marmite indirecte à gaz 100 lt. Cuve Ø cm. 60x42h (inclus 1 Élément de jonction top mod.TPA-9) • **ES** Marmita de calefacción indirecta a gas lt. 100 Cuba Ø cm. 60x42h (incluida 1 Chapa de cierre para top mod.TPA-9)
cm. 80x 90x 90h



⚡ 21 kW **9.281,00**
18.060 kcal/h 131 / 1,07

PENTOLE A GAS

MOD. _____
COD. _____

DESCRIZIONE/DESCRIPTION/BEZEICHNUNG/DESCRIPTION/DESCRIPCIÓN
DIMENSIONI/DIMENSIONS/ABMESSUNGEN/DIMENSIONS/DIMENSIONES

POTENZA/POWER/LEISTUNG/PUISSANCE/POTENCIA
VOLTAGGIO/VOLTAGE/SPANNUNG/VOLTAGE/VOLTAJE

⚡ 21 kW
18.060 kcal/h

⚡ 0,1 KW
230V~
50/60 Hz

PREZZO/PRICE
PREIS/PRIX/PRECIO
KG / M³



PI100A-98G PENTOLA INDIRETTA GAS LT.100 VASCA Ø CM. 60X42H - CARICO AUTOMATICO INTERCAPEDINE (INCLUSA 1 TESTATA CHIUSURA PIANO MOD.TPA-9)

0928A851

EN Gas indirect boiling pan 100 lts. Tank Ø cm. 60x42h - automatic water-charge of double jacket (included 1 Head end filler strip mod. TPA-9) • **DE** Indirekter Gas-Kochkessel 100 lt. Becken Ø cm. 60x42h - automatische Wasserstandskontrolle im Zwischenmantel (inbegriffen 1 Abschluss-Element mod.TPA-9) • **FR** Marmite indirecte à gaz 100 lt. Cuve Ø cm. 60x42h - remplissage automatique dans la double paroi (inclus 1 Élément de jonction top mod.TPA-9) • **ES** Marmita de calefacción indirecta a gas lt. 100 Cuba Ø cm. 60x42h - carga automática de la camisa intercambiador (incluida 1 Chapa de cierre para top mod.TPA-9)
cm. 80x 90x 90h



⚡ 21 kW **11.689,00**
18.060 kcal/h 131 / 1,07

⚡ 0,1 KW
230V~
50/60 Hz

PIA100-98G PENTOLA INDIRETTA GAS LT. 100 AUTOCLAVE VASCA Ø CM. 60X42H (INCLUSA 1 TESTATA CHIUSURA PIANO MOD.TPA-9)

09280853

EN Gas indirect boiling pan 100 lts. - Autoclave Tank Ø cm. 60x42h (included 1 Head end filler strip mod.TPA-9) • **DE** Indirekter Gas-Kochkessel 100 lt. - Druckkessel Becken Ø cm. 60x42h (inbegriffen 1 Abschluss-Element mod.TPA-9) • **FR** Marmite indirecte gaz 100 lt. - Autoclave Cuve Ø cm. 60x42h (inclus 1 Élément de jonction top mod. TPA-9) • **ES** Marmita de calefacción indirecta 100 lt. - Autoclave Cuba Ø cm. 60x42h (incluida 1 Chapa de cierre para top mod.TPA-9)
cm. 80x 90x 90h

⚡ 21 kW **10.886,00**
18.060 kcal/h 136 / 1,07

PIA100A-98G PENTOLA INDIRETTA GAS LT. 100 AUTOCLAVE VASCA Ø CM. 60X42H - CARICO AUTOMATICO INTERCAPEDINE (INCLUSA 1 TESTATA CHIUSURA PIANO MOD.TPA-9)

0928A853

EN Gas indirect boiling pan 100 lts. - Autoclave Tank Ø cm. 60x42h - automatic water-charge of double jacket (included 1 Head end filler strip mod.TPA-9) • **DE** Indirekter Gas-Kochkessel 100 lt. - Druckkessel Becken Ø cm. 60x42h - automatische Wasserstandskontrolle im Zwischenmantel (inbegriffen 1 Abschluss-Element mod.TPA-9) • **FR** Marmite indirecte gaz 100 lt. - Autoclave Cuve Ø cm. 60x42h - remplissage automatique dans la double paroi (inclus 1 Élément de jonction top mod.TPA-9) • **ES** Marmita de calefacción indirecta 100 lt. - Autoclave Cuba Ø cm. 60x42h - carga automática de la camisa intercambiador (incluida 1 Chapa de cierre para top mod.TPA-9)
cm. 80x 90x 90h

⚡ 21 kW **13.293,00**
18.060 kcal/h 136 / 1,07

⚡ 0,1 KW
230V~
50/60 Hz

531043401 OPTIONAL: CESTO 1/1 PER PENTOLA 100 LT

EN Optional: Basket 1/1 for boiling pan • **DE** Zubehör: Korb 1/1 für Kochkessel • **FR** En option: Panier 1/1 pour marmite • **ES** Opcional: Cesta 1/1 por marmita
cm. Ø 56x 34,5h

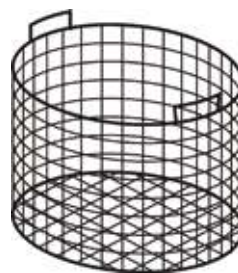

1.169,00
5 / 0,18

531043501 OPTIONAL: CESTO 1/1 PER PENTOLA 150 LT

EN Optional: Basket 1/1 for boiling pan • **DE** Zubehör: Korb 1/1 für Kochkessel • **FR** En option: Panier 1/1 pour marmite • **ES** Opcional: Cesta 1/1 por marmita
cm. Ø 56x 47h

1.219,00
5 / 0,22

531043601 OPTIONAL: CESTO 1/2 PER PENTOLA 100 LT

EN Optional: Basket 1/2 for boiling pan • **DE** Zubehör: Korb 1/2 für Kochkessel • **FR** En option: Panier 1/2 pour marmite • **ES** Opcional: Cesta 1/2 por marmita
cm. Ø 56x 34,5h

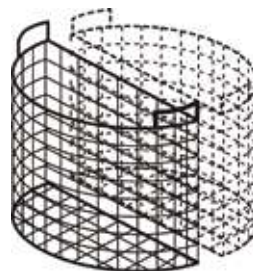

715,00
2.5 / 0,11

531043701 OPTIONAL: CESTO 1/2 PER PENTOLA 150 LT

EN Optional: Basket 1/2 for boiling pan • **DE** Zubehör: Korb 1/2 für Kochkessel • **FR** En option: Panier 1/2 pour marmite • **ES** Opcional: Cesta 1/2 por marmita
cm. Ø 56x 47h

869,00
2.5 / 0,13

MOD. _____
COD. _____

DESCRIZIONE/DESCRIPTION/BEZEICHNUNG/DESCRIPTION/DESCRIPCIÓN
DIMENSIONI/DIMENSIONS/ABMESSUNGEN/DIMENSIONS/DIMENSIONES

POTENZA/POWER/LEISTUNG/PUISSANCE/POTENCIA
VOLTAGGIO/VOLTAGE/SPANNUNG/VOLTAGE/VOLTAJE

⚡ kW _____
kcal/h _____
⚡ kw _____
V~ _____
Hz _____

PREZZO/PRICE
PREIS/PRIX/PRECIO
KG / M³



ISP
09580020

OPTIONAL: IMBUTO PER SCARICO PENTOLE
EN Optional: Channel for pan drainage • **DE** Zubehör: Trichter zum Entleeren der Töpfe • **FR** En option: Entonnoir pour vidange marmites • **ES** Opcional: Embudo para descargar marmitas



154,00
5 / 0,04

PI150-98ET PENTOLA INDIRETTA ELETTRICA LT. 135 VASCA Ø CM.
09110836 **60X54H (INCLUSA 1 TESTATA CHIUSURA PIANO MOD.TPA-9)**

EN Electric indirect boiling pan 135 lts. Tank Ø cm. 60x54h (included 1 Head end filler strip mod.TPA-9) • **DE** Indirekter Elektro-Kochkessel 135 lt. Becken Ø cm. 60x54h (inbegriffen 1 Abschluss-Element mod.TPA-9) • **FR** Marmite indirecte électrique 135 lt. Cuve Ø cm. 60x54h (inclus 1 Élément de jonction top mod.TPA-9) • **ES** Marmita de calefacción indirecta 135 lt. Cuba Ø cm. 60x54h (incluida 1 Chapa de cierre para top mod.TPA-9)
cm. 80x 90x 90h



⚡ 18 kW _____ **9.443,00**
400V~3N _____ 110 / 1,07
50/60 Hz _____

PI150A-98ET PENTOLA INDIRETTA ELETTRICA LT. 135 VASCA Ø CM.
0911A836 **60X54H - CARICO AUTOMATICO INTERCAPEDINE (INCLUSA 1 TESTATA CHIUSURA PIANO MOD.TPA-9)**

EN Electric indirect boiling pan 135 lts. Tank Ø cm. 60x54h - automatic water-charge of double jacket (included 1 Head end filler strip mod.TPA-9) • **DE** Indirekter Elektro-Kochkessel 135 lt. Becken Ø cm. 60x54h - automatische Wasserstandskontrolle im Zwischenmantel (inbegriffen 1 Abschluss-Element mod.TPA-9) • **FR** Marmite indirecte électrique 135 lt. Cuve Ø cm. 60x54h - remplissage automatique dans la double paroi (inclus 1 Élément de jonction top mod.TPA-9) • **ES** Marmita de calefacción indirecta 135 lt. Cuba Ø cm. 60x54h - carga automática de la camisa intercambiador (incluida 1 Chapa de cierre para top mod.TPA-9)
cm. 80x 90x 90h

⚡ 18 kW _____ **11.688,00**
400V~3N _____ 110 / 1,07
50/60 Hz _____

PIA150-98ET PENTOLA INDIRETTA ELETTRICA LT. 135 AUTOCLAVE - VASCA
09110837 **CM. Ø 60X54H (INCLUSA 1 TESTATA CHIUSURA PIANO MOD.TPA-9)**

EN Electric indirect boiling pan 135 lts. - Autoclave Tank Ø cm. 60x54h (included 1 Head end filler strip mod.TPA-9) • **DE** Indirekter Elektro-Kochkessel 135 lt. - Druckkessel Becken Ø cm. 60x54h (inbegriffen 1 Abschluss-Element mod.TPA-9) • **FR** Marmite indirecte électrique 135 lt. - Autoclave Cuve Ø cm. 60x54h (inclus 1 Élément de jonction top mod.TPA-9) • **ES** Marmita de calefacción 135 lt. - Autoclave Cuba Ø cm. 60x54h (incluida 1 Chapa de cierre para top mod.TPA-9)
cm. 80x 90x 90h

⚡ 18 kW _____ **11.102,00**
400V~3N _____ 116 / 1,07
50/60 Hz _____

PIA150A-98ET PENTOLA INDIRETTA ELETTRICA LT. 135 AUTOCLAVE - VASCA
0911A837 **CM. Ø 60X54H - CARICO AUTOMATICO INTERCAPEDINE (INCLUSA 1 TESTATA CHIUSURA PIANO MOD.TPA-9)**

EN Electric indirect boiling pan 135 lts. - Autoclave Tank Ø cm. 60x54h - automatic water-charge of double jacket (included 1 Head end filler strip mod.TPA-9) • **DE** Indirekter Elektro-Kochkessel 135 lt. - Druckkessel Becken Ø cm. 60x54h - automatische Wasserstandskontrolle im Zwischenmantel (inbegriffen 1 Abschluss-Element mod.TPA-9) • **FR** Marmite indirecte électrique 135 lt. - Autoclave Cuve Ø cm. 60x54h - remplissage automatique dans la double paroi (inclus 1 Élément de jonction top mod.TPA-9) • **ES** Marmita de calefacción 135 lt. - Autoclave Cuba Ø cm. 60x54h - carga automática de la camisa intercambiador (incluida 1 Chapa de cierre para top mod.TPA-9)
cm. 80x 90x 90h

⚡ 18 kW _____ **13.346,00**
400V~3N _____ 116 / 1,07
50/60 Hz _____

PENTOLE A GAS

MOD. _____
COD. _____

DESCRIZIONE/DESCRIPTION/BEZEICHNUNG/DESCRIPTION/DESCRIPCIÓN
DIMENSIONI/DIMENSIONS/ABMESSUNGEN/DIMENSIONS/DIMENSIONES

POTENZA/POWER/LEISTUNG/PUISSANCE/POTENCIA
VOLTAGGIO/VOLTAGE/SPANNUNG/VOLTAGE/VOLTAJE

$\frac{kW}{kcal/h}$ $\frac{kW}{V\sim}$
Hz

PREZZO/PRICE
PREIS/PRIX/PRECIO
KG / M³



PD150-98G PENTOLA DIRETTA GAS LT. 140 VASCA Ø CM. 60X54H
09280854 **(INCLUSA 1 TESTATA CHIUSURA PIANO MOD.TPA-9)**

EN Gas direct boiling pan 140 lts. Tank Ø cm. 60x54h (included 1 Head end filler strip mod.TPA-9) • **DE** Direkter Gas-Kochkessel 140 lt. Becken Ø cm. 60x54h (inbegriffen 1 Abschluss-Element mod.TPA-9) • **FR** Marmite directe à gaz 140 lt. Cuve Ø cm. 60x54h (inclus 1 Élément de jonction top mod.TPA-9) • **ES** Marmita de calefacción directa lt. 140 Cuba Ø cm. 60x54h (incluida 1 Chapa de cierre para top mod.TPA-9)
cm. 80x 90x 90h



$\frac{21 kW}{18.060 kcal/h}$ **7.277,00**
108 / 1,07

PDA150-98G PENTOLA DIRETTA GAS LT. 140 AUTOCLAVE VASCA Ø CM. 60X54H (INCLUSA 1 TESTATA CHIUSURA PIANO MOD.TPA-9)
09280855

EN Gas direct boiling pan 140 lts. - Autoclave Tank Ø cm. 60x54h (included 1 Head end filler strip mod.TPA-9) • **DE** Direkter Gas-Kochkessel 140 lt. - Druckkessel Becken Ø cm. 60x54h (inbegriffen 1 Abschluss-Element mod.TPA-9) • **FR** Marmite directe à gaz 140 lt. - Autoclave Cuve Ø cm. 60x54h (inclus 1 Élément de jonction top mod.TPA-9) • **ES** Marmita de calefacción directa lt. 140 - Autoclave Cuba Ø cm. 60x54h (incluida 1 Chapa de cierre para top mod.TPA-9)
cm. 80x 90x 90h

$\frac{21 kW}{18.060 kcal/h}$ **8.919,00**
113 / 1,07

PI150-98G PENTOLA INDIRETTA GAS LT. 135 VASCA Ø CM. 60X54H
09280856 **(INCLUSA 1 TESTATA CHIUSURA PIANO MOD.TPA-9)**

EN Gas indirect boiling pan 135 lts. Tank Ø cm. 60x54h (included 1 Head end filler strip mod.TPA-9) • **DE** Indirekter Gas-Kochkessel 135 lt. Becken Ø cm. 60x54h (inbegriffen 1 Abschluss-Element mod.TPA-9) • **FR** Marmite indirecte à gaz 135 lt. Cuve Ø cm. 60x54h (inclus 1 Élément de jonction top mod.TPA-9) • **ES** Marmita de calefacción Indirecta lt. 135 Cuba Ø cm. 60x54h (incluida 1 Chapa de cierre para top mod.TPA-9)
cm. 80x 90x 90h



$\frac{21 kW}{18.060 kcal/h}$ **9.608,00**
135 / 1,07

PI150A-98G PENTOLA INDIRETTA GAS LT. 135 VASCA Ø CM. 60X54H - CARICO AUTOMATICO INTERCAPEDINE (INCLUSA 1 TESTATA CHIUSURA PIANO MOD.TPA-9)
0928A856

EN Gas indirect boiling pan 135 lts. Tank Ø cm. 60x54h - automatic water-charge of double jacket (included 1 Head end filler strip mod.TPA-9) • **DE** Indirekter Gas-Kochkessel 135 lt. Becken Ø cm. 60x54h - automatische Wasserstandskontrolle im Zwischenmantel (inbegriffen 1 Abschluss-Element mod.TPA-9) • **FR** Marmite indirecte à gaz 135 lt. Cuve Ø cm. 60x54h - remplissage automatique dans la double paroi (inclus 1 Élément de jonction top mod.TPA-9) • **ES** Marmita de calefacción Indirecta lt. 135 Cuba Ø cm. 60x54h - carga automática de la camisa intercambiador (incluida 1 Chapa de cierre para top mod.TPA-9)
cm. 80x 90x 90h

$\frac{21 kW}{18.060 kcal/h}$ **12.013,00**
135 / 1,07

$\frac{0,1 KW}{230V\sim}$
50/60 Hz

PIA150-98G PENTOLA INDIRETTA GAS LT. 135 AUTOCLAVE VASCA Ø CM. 60X54H (INCLUSA 1 TESTATA CHIUSURA PIANO MOD.TPA-9)
09280857

EN Gas indirect boiling pan 135 lts. - Autoclave Tank Ø cm. 60x54h (included 1 Head end filler strip mod.TPA-9) • **DE** Indirekter Gas-Kochkessel 135 lt. - Druckkessel Becken Ø cm. 60x54h (inbegriffen 1 Abschluss-Element mod.TPA-9) • **FR** Marmite indirecte électrique à gaz 135 lt. - Autoclave Cuve Ø cm. 60x54h (inclus 1 Élément de jonction top mod.TPA-9) • **ES** Marmita de calefacción indirecta a gas 135 lt. - Autoclave Cuba Ø cm. 60x54h (incluida 1 Chapa de cierre para top mod.TPA-9)
cm. 80x 90x 90h

$\frac{21 kW}{18.060 kcal/h}$ **11.248,00**
115 / 1,07

PIA150A-98G PENTOLA INDIRETTA GAS LT. 135 AUTOCLAVE VASCA Ø CM. 60X54H - CARICO AUTOMATICO INTERCAPEDINE (INCLUSA 1 TESTATA CHIUSURA PIANO MOD.TPA-9)
0928A857

EN Gas indirect boiling pan 135 lts. - Autoclave Tank Ø cm. 60x54h - automatic water-charge of double jacket (included 1 Head end filler strip mod.TPA-9) • **DE** Indirekter Gas-Kochkessel 135 lt. - Druckkessel Becken Ø cm. 60x54h - automatische Wasserstandskontrolle im Zwischenmantel (inbegriffen 1 Abschluss-Element mod.TPA-9) • **FR** Marmite indirecte électrique à gaz 135 lt. - Autoclave Cuve Ø cm. 60x54h - remplissage automatique dans la double paroi (inclus 1 Élément de jonction top mod.TPA-9) • **ES** Marmita de calefacción indirecta a gas 135 lt. - Autoclave Cuba Ø cm. 60x54h - carga automática de la camisa intercambiador (incluida 1 Chapa de cierre para top mod.TPA-9)
cm. 80x 90x 90h

$\frac{21 kW}{18.060 kcal/h}$ **13.656,00**
115 / 1,07

$\frac{0,1 KW}{230V\sim}$
50/60 Hz

FRY-TOP ELETTRICI

MOD. _____
COD. _____

DESCRIZIONE/DESCRIPTION/BEZEICHNUNG/DESCRIPTION/DESCRIPCIÓN
DIMENSIONI/DIMENSIONS/ABMESSUNGEN/DIMENSIONS/DIMENSIONES

POTENZA/POWER/LEISTUNG/PUISSANCE/POTENCIA
VOLTAGGIO/VOLTAGE/SPANNUNG/VOLTAGE/VOLTAJE

⚡ kW kcal/h
⚡ kW V~ Hz

PREZZO/PRICE
PREIS/PRIX/PRECIO
KG / M³



FTL-94ET
09060431

FRY-TOP ELETTRICO LISCIO, SU MOBILE A GIORNO, PIASTRA CM.36X68 (INCLUSA 1 TESTATA CHIUSURA PIANO MOD. TPA-9)

EN Electric Fry-top smooth griddle, on open cabinet, plate cm.36x68 (included 1 Head end filler strip mod.TPA-9) • **DE** Griddleplatte elektrische glatt, mit offenem Unterbau, platte cm.36x68 (inbegriffen 1 Abschluss-Element mod.TPA-9) • **FR** Plaque électriques lisse, sur armoire ouvert, plaque cm.36x68 (inclus 1 Élément de jonction top mod.TPA-9) • **ES** Fry-top eléctrico liso, sobre mueble abierto, plancha cm.36x68 (incluida 1 Chapa de cierre para top mod.TPA-9)
cm. 40x 90x 90h



⚡ 7,5 kW **2.580,00**
400V~3N 79 / 0,46
50/60 Hz

FTL-94ETS
09060434

FRY-TOP ELETTRICO LISCIO CROMATO SUPERCHROME (MOCA APPROVED), SU MOBILE A GIORNO, PIASTRA CM.36X68 (INCLUSA 1 TESTATA CHIUSURA PIANO MOD.TPA-9)

EN Electric Fry-top smooth chromed griddle SUPERCHROME (Moca Approved), on open cabinet, plate cm.36x68 (included 1 Head end filler strip mod.TPA-9) • **DE** Griddleplatte elektrische glatt hartverchromt SUPERCHROME (Moca Approved), mit offenem Unterbau, platte cm.36x68 (inbegriffen 1 Abschluss-Element mod.TPA-9) • **FR** Plaque électriques lisse chromée SUPERCHROME (Moca Approved), sur armoire ouvert, plaque cm.36x68 (inclus 1 Élément de jonction top mod.TPA-9) • **ES** Fry-top eléctrico liso cromado SUPERCHROME (Moca Approved), sobre mueble abierto, plancha cm.36x68 (incluida 1 Chapa de cierre para top mod.TPA-9)
cm. 40x 90x 90h

⚡ 7,5 kW **3.058,00**
400V~3N 79 / 0,46
50/60 Hz

FTL-94ETSS
09060430

FRY-TOP ELETTRICO LISCIO CROMO LUCIDO, SU MOBILE A GIORNO, PIASTRA CM.36X68 (INCLUSA 1 TESTATA CHIUSURA PIANO MOD.TPA-9)

EN Electric Fry-top smooth POLISHED CHROME, on open cabinet, plate cm.36x68 (included 1 Head end filler strip mod.TPA-9) • **DE** Griddleplatte elektrische glatt POLIERTEM CHROM, mit offenem Unterbau, platte cm.36x68 (inbegriffen 1 Abschluss-Element mod.TPA-9) • **FR** Plaque électriques lisse CHROME POLL, sur armoire ouvert, plaque cm.36x68 (inclus 1 Élément de jonction top mod.TPA-9) • **ES** Fry-top eléctrico liso CROMO PULIDO, sobre mueble abierto, plancha cm.36x68 (incluida 1 Chapa de cierre para top mod.TPA-9)
cm. 40x 90x 90h

⚡ 7,5 kW **3.058,00**
400V~3N 79 / 0,46
50/60 Hz

FTR-94ET
09060433

FRY-TOP ELETTRICO RIGATO, SU MOBILE A GIORNO, PIASTRA CM.36X68 (INCLUSA 1 TESTATA CHIUSURA PIANO MOD. TPA-9)

EN Electric Fry-top grooved griddle, on open cabinet, plate cm.36x68 (included 1 Head end filler strip mod.TPA-9) • **DE** Griddleplatte elektrische gerillt, mit offenem Unterbau, platte cm.36x68 (inbegriffen 1 Abschluss-Element mod.TPA-9) • **FR** Plaque électriques nervurée, sur armoire ouvert, plaque cm.36x68 (inclus 1 Élément de jonction top mod.TPA-9) • **ES** Fry-top eléctrico estriado, sobre mueble abierto, plancha cm.36x68 (incluida 1 Chapa de cierre para top mod.TPA-9)
cm. 40x 90x 90h



⚡ 7,5 kW **2.762,00**
400V~3N 79 / 0,46
50/60 Hz

FTR-94ETS
09060436

FRY-TOP ELETTRICO RIGATO CROMATO SUPERCHROME (MOCA APPROVED), SU MOBILE A GIORNO, PIASTRA CM.36X68 (INCLUSA 1 TESTATA CHIUSURA PIANO MOD. TPA-9)

EN Electric Fry-top grooved chromed griddle SUPERCHROME (Moca Approved), on open cabinet, plate cm.36x68 (included 1 Head end filler strip mod.TPA-9) • **DE** Griddleplatte elektrische gerillt hartverchromt SUPERCHROME (Moca Approved), mit offenem Unterbau, platte cm.36x68 (inbegriffen 1 Abschluss-Element mod.TPA-9) • **FR** Plaque électriques nervurée chromée SUPERCHROME (Moca Approved), sur armoire ouvert, plaque cm.36x68 (inclus 1 Élément de jonction top mod.TPA-9) • **ES** Fry-top eléctrico estriado cromado SUPERCHROME (Moca Approved), sobre mueble abierto, plancha cm.36x68 (incluida 1 Chapa de cierre para top mod.TPA-9)
cm. 40x 90x 90h

⚡ 7,5 kW **3.237,00**
400V~3N 79 / 0,46
50/60 Hz

FRY-TOP ELETTRICI

MOD. _____
COD. _____

DESCRIZIONE/DESCRIPTION/BEZEICHNUNG/DESCRIPTION/DESCRIPCIÓN
DIMENSIONI/DIMENSIONS/ABMESSUNGEN/DIMENSIONS/DIMENSIONES

POTENZA/POWER/LEISTUNG/PUISSANCE/POTENCIA
VOLTAGGIO/VOLTAGE/SPANNUNG/VOLTAGE/VOLTAJE

⚡ kcal/h ⚡ kW
V~ Hz

PREZZO/PRICE
PREIS/PRIX/PRECIO
KG / M³



FTL-98ET
09060831

FRY-TOP ELETTRICO LISCIO, SU MOBILE A GIORNO, PIASTRA CM.76X68 - 2 ZONE DI COTTURA (INCLUSA 1 TESTATA CHIUSURA PIANO MOD.TPA-9)

EN Electric Fry-top smooth griddle, on open cabinet, plate cm.76x68 - 2 cooking areas (included 1 Head end filler strip mod.TPA-9) • **DE** Griddleplatte elektrische glatt, mit offenem Unterbau, platte cm.76x68 - 2 Heizzonen (inbegriffen 1 Abschluss-Element mod.TPA-9) • **FR** Plaque électriques lisse, sur armoire ouvert, plaque cm.76x68 - 2 zones de cuisson (inclus 1 Élément de jonction top mod.TPA-9) • **ES** Fry-top eléctrico liso, sobre mueble abierto, plancha cm.76x68 - 2 zonas de cocción (incluida 1 Chapa de cierre para top mod.TPA-9)
cm. 80x 90x 90h



⚡ 15 kW **3.754,00**
400V~3N 126 / 0,89
50/60 Hz

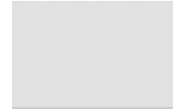

FTL-98ETS
09060834

FRY-TOP ELETTRICO LISCIO CROMATO SUPERCHROME (MOCA APPROVED), SU MOBILE A GIORNO, PIASTRA CM.76X68 - 2 ZONE DI COTTURA (INCLUSA 1 TESTATA CHIUSURA PIANO MOD.TPA-9)

EN Electric Fry-top smooth chromed griddle SUPERCHROME (Moca Approved), on open cabinet, plate cm.76x68 - 2 cooking areas (included 1 Head end filler strip mod.TPA-9) • **DE** Griddleplatte elektrische glatt hartverchromt SUPERCHROME (Moca Approved), mit offenem Unterbau, platte cm.76x68 - 2 Heizzonen (inbegriffen 1 Abschluss-Element mod.TPA-9) • **FR** Plaque électriques lisse chromée SUPERCHROME (Moca Approved), sur armoire ouvert, plaque cm.76x68 - 2 zones de cuisson (inclus 1 Élément de jonction top mod.TPA-9) • **ES** Fry-top eléctrico liso cromado SUPERCHROME (Moca Approved), sobre mueble abierto, plancha cm.76x68 - 2 zonas de cocción (incluida 1 Chapa de cierre para top mod.TPA-9)
cm. 80x 90x 90h

⚡ 15 kW **4.467,00**
400V~3N 126 / 0,89
50/60 Hz

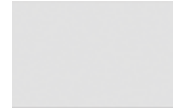

FTL-98ETSS
09060830

FRY-TOP ELETTRICO LISCIO CROMO LUCIDO, SU MOBILE A GIORNO, PIASTRA CM.76X68 - 2 ZONE DI COTTURA (INCLUSA 1 TESTATA CHIUSURA PIANO MOD.TPA-9)

EN Electric Fry-top smooth POLISHED CHROME, on open cabinet, plate cm.76x68 - 2 cooking areas (included 1 Head end filler strip mod.TPA-9) • **DE** Griddleplatte elektrische glatt POLIERTEM CHROM, mit offenem Unterbau, platte cm.76x68 - 2 Heizzonen (inbegriffen 1 Abschluss-Element mod.TPA-9) • **FR** Plaque électriques lisse CHROME POLI, sur armoire ouvert, plaque cm.76x68 - 2 zones de cuisson (inclus 1 Élément de jonction top mod.TPA-9) • **ES** Fry-top eléctrico liso CROMO PULIDO, sobre mueble abierto, plancha cm.76x68 - 2 zonas de cocción (incluida 1 Chapa de cierre para top mod.TPA-9)
cm. 80x 90x 90h

⚡ 15 kW **4.467,00**
400V~3N 126 / 0,89
50/60 Hz

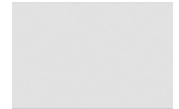

FTLR-98ET
09060832

FRY-TOP ELETTRICO 1/2 RIGATO + 1/2 LISCIO, SU MOBILE A GIORNO, PIASTRA CM.76X68 - 2 ZONE DI COTTURA (INCLUSA 1 TESTATA CHIUSURA PIANO MOD.TPA-9)

EN Electric Fry-top 1/2 grooved + 1/2 smooth, on open cabinet, plate cm.76x68 - 2 cooking areas (included 1 Head end filler strip mod.TPA-9) • **DE** Griddleplatte elektrische 1/2 gerillt + 1/2 glatt, mit offenem Unterbau, platte cm.76x68 - 2 Heizzonen (inbegriffen 1 Abschluss-Element mod.TPA-9) • **FR** Plaque électriques 1/2 nervurée + 1/2 lisse, sur armoire ouvert, plaque cm.76x68 - 2 zones de cuisson (inclus 1 Élément de jonction top mod.TPA-9) • **ES** Fry-top eléctrico 1/2 estriado + 1/2 liso, sobre mueble abierto, plancha cm.76x68 - 2 zonas de cocción (incluida 1 Chapa de cierre para top mod.TPA-9)
cm. 80x 90x 90h



⚡ 15 kW **3.973,00**
400V~3N 126 / 0,89
50/60 Hz



FRY-TOP ELETTRICI

MOD. _____
COD. _____

DESCRIZIONE/DESCRIPTION/BEZEICHNUNG/DESCRIPTION/DESCRIPCIÓN
DIMENSIONI/DIMENSIONS/ABMESSUNGEN/DIMENSIONS/DIMENSIONES

POTENZA/POWER/LEISTUNG/PUISSANCE/POTENCIA
VOLTAGGIO/VOLTAGE/SPANNUNG/VOLTAGE/VOLTAJE

⚡ kW kcal/h
V~ Hz

PREZZO/PRICE
PREIS/PRIX/PRECIO
KG / M³



FTLR-98ETS
09060835

FRY-TOP ELETTRICO 1/2 RIGATO + 1/2 LISCIO CROMATO SUPERCHROME (MOCA APPROVED), SU MOBILE A GIORNO, PIASTRA CM.76X68 - 2 ZONE DI COTTURA (INCLUSA 1 TESTATA CHIUSURA PIANO MOD.TPA-9)

EN Electric Fry-top 1/2 grooved + 1/2 smooth chromed griddle SUPERCHROME (Moca Approved), on open cabinet, plate cm.76x68 - 2 cooking areas (included 1 Head end filler strip mod.TPA-9)
• **DE** Griddleplatte elektrische 1/2 gerillt + 1/2 glatt hartverchromt SUPERCHROME (Moca Approved), mit offenem Unterbau, platte cm.76x68 - 2 Heizzonen (inbegriffen 1 Abschluss-Element mod.TPA-9)
• **FR** Plaque électriques 1/2 nervurée + 1/2 lisse chromée SUPERCHROME (Moca Approved), sur armoire ouvert, plaque cm.76x68 - 2 zones de cuisson (inclus 1 Élément de jonction top mod.TPA-9)
• **ES** Fry-top eléctrico 1/2 estriado + 1/2 liso cromado SUPERCHROME (Moca Approved), sobre mueble abierto, plancha cm.76x68 - 2 zonas de cocción (incluida 1 Chapa de cierre para top mod.TPA-9)
cm. 80x 90x 90h



⚡ 15 kW **4.681,00**
400V~3N 126 / 0,89
50/60 Hz



FTR-98ET
09060833

FRY-TOP ELETTRICO RIGATO, SU MOBILE A GIORNO, PIASTRA CM.76X68 - 2 ZONE DI COTTURA (INCLUSA 1 TESTATA CHIUSURA PIANO MOD.TPA-9)

EN Electric Fry-top grooved griddle, on open cabinet, plate cm.76x68 - 2 cooking areas (included 1 Head end filler strip mod.TPA-9)
• **DE** Griddleplatte elektrische gerillt, mit offenem Unterbau, platte cm.76x68 - 2 Heizzonen (inbegriffen 1 Abschluss-Element mod.TPA-9)
• **FR** Plaque électriques nervurée, sur armoire ouvert, plaque cm.76x68 - 2 zones de cuisson (inclus 1 Élément de jonction top mod.TPA-9)
• **ES** Fry-top eléctrico estriado, sobre mueble abierto, plancha cm.76x68 - 2 zonas de cocción (incluida 1 Chapa de cierre para top mod.TPA-9)
cm. 80x 90x 90h



⚡ 15 kW **4.191,00**
400V~3N 126 / 0,89
50/60 Hz



FTR-98ETS
09060836

FRY-TOP ELETTRICO RIGATO CROMATO SUPERCHROME (MOCA APPROVED), SU MOBILE A GIORNO, PIASTRA CM.76X68 - 2 ZONE DI COTTURA (INCLUSA 1 TESTATA CHIUSURA PIANO MOD.TPA-9)

EN Electric Fry-top grooved chromed griddle SUPERCHROME (Moca Approved), on open cabinet, plate cm.76x68 - 2 cooking areas (included 1 Head end filler strip mod.TPA-9)
• **DE** Griddleplatte elektrische gerillt hartverchromt SUPERCHROME (Moca Approved), mit offenem Unterbau, platte cm.76x68 - 2 Heizzonen (inbegriffen 1 Abschluss-Element mod.TPA-9)
• **FR** Plaque électriques nervurée chromée SUPERCHROME (Moca Approved), sur armoire ouvert, plaque cm.76x68 - 2 zones de cuisson (inclus 1 Élément de jonction top mod.TPA-9)
• **ES** Fry-top eléctrico estriado cromado SUPERCHROME (Moca Approved), sobre mueble abierto, plancha cm.76x68 - 2 zonas de cocción (incluida 1 Chapa de cierre para top mod.TPA-9)
cm. 80x 90x 90h

⚡ 15 kW **4.899,00**
400V~3N 126 / 0,89
50/60 Hz



FTL-912ET
0906123B

FRY-TOP ELETTRICO LISCIO, SU MOBILE A GIORNO, PIASTRA CM.110,5X65 - 3 ZONE DI COTTURA (INCLUSA 1 TESTATA CHIUSURA PIANO MOD.TPA-9)

EN Electric Fry-top smooth griddle, on open cabinet, plate cm.110,5x65 - 3 cooking areas (included 1 Head end filler strip mod.TPA-9)
• **DE** Griddleplatte elektrische glatt, mit offenem Unterbau, platte cm.110,5x65 - 3 Heizzonen (inbegriffen 1 Abschluss-Element mod.TPA-9)
• **FR** Plaque électriques lisse, sur armoire ouvert, plaque cm.110,5x65 - 3 zones de cuisson (inclus 1 Élément de jonction top mod.TPA-9)
• **ES** Fry-top eléctrico liso, sobre mueble abierto, plancha cm.110,5x65 - 3 zonas de cocción (incluida 1 Chapa de cierre para top mod.TPA-9)
cm. 120x 90x 90h



⚡ 22,5 kW **5.668,00**
400V~3N 186 / 1,32
50/60 Hz



FRY-TOP ELETTRICI

MOD. _____
COD. _____

DESCRIZIONE/DESCRIPTION/BEZEICHNUNG/DESCRIPTION/DESCRIPCIÓN
DIMENSIONI/DIMENSIONS/ABMESSUNGEN/DIMENSIONS/DIMENSIONES

POTENZA/POWER/LEISTUNG/PUISSANCE/POTENCIA
VOLTAGGIO/VOLTAGE/SPANNUNG/VOLTAGE/VOLTAJE

⚡ kW _____
kcal/h _____
V~ _____
Hz _____

PREZZO/PRICE
PREIS/PRIX/PRECIO
KG / M³



FTL-912ETS **FRY-TOP ELETTRICO LISCIO CROMATO SUPERCHROME (MOCA APPROVED), SU MOBILE A GIORNO, PIASTRA CM.110,5X65 - 3 ZONE DI COTTURA (INCLUSA 1 TESTATA CHIUSURA PIANO MOD.TPA-9)**
0906123E

EN Electric Fry-top smooth chromed griddle SUPERCHROME (Moca Approved), on open cabinet, plate cm.110,5x65 - 3 cooking areas (included 1 Head end filler strip mod.TPA-9) • **DE** Griddleplatte elektrische glatt hartverchromt SUPERCHROME (Moca Approved), mit offenem Unterbau, platte cm.110,5x65 - 3 Heizzonen (inbegriffen 1 Abschluss-Element mod.TPA-9) • **FR** Plaque électriques lisse chromée SUPERCHROME (Moca Approved), sur armoire ouvert, plaque cm.110,5x65 - 3 zones de cuisson (inclus 1 Élément de jonction top mod.TPA-9) • **ES** Fry-top eléctrico liso cromado SUPERCHROME (Moca Approved), sobre mueble abierto, plancha cm.110,5x65 - 3 zonas de cocción (incluida 1 Chapa de cierre para top mod.TPA-9)
cm. 120x 90x 90h



⚡ 22,5 kW _____ **6.527,00**
400V~3N _____ 186 / 1,32
50/60 Hz _____

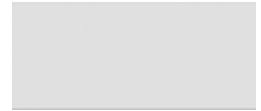

FTLR-912ET **FRY-TOP ELETTRICO 1/3 RIGATO + 2/3 LISCIO, SU MOBILE A GIORNO, PIASTRA CM.110,5X65 - 3 ZONE DI COTTURA (INCLUSA 1 TESTATA CHIUSURA PIANO MOD.TPA-9)**
0906123C

EN Electric Fry-top 1/3 grooved + 2/3 smooth, on open cabinet, plate cm.110,5x65 - 3 cooking areas (included 1 Head end filler strip mod.TPA-9) • **DE** Griddleplatte elektrische 1/3 gerillt + 2/3 glatt, mit offenem Unterbau, platte cm.110,5x65 - 3 Heizzonen (inbegriffen 1 Abschluss-Element mod.TPA-9) • **FR** Plaque électriques 1/3 nervurée + 2/3 lisse, sur armoire ouvert, plaque cm.110,5x65 - 3 zones de cuisson (inclus 1 Élément de jonction top mod.TPA-9) • **ES** Fry-top eléctrico 1/3 estriado + 2/3 liso, sobre mueble abierto, plancha cm.110,5x65 - 3 zonas de cocción (incluida 1 Chapa de cierre para top mod.TPA-9)
cm. 120x 90x 90h



⚡ 22,5 kW _____ **6.032,00**
400V~3N _____ 186 / 1,32
50/60 Hz _____



FTLR-912ETS **FRY-TOP ELETTRICO 1/3 RIGATO + 2/3 LISCIO CROMATO SUPERCHROME (MOCA APPROVED), SU MOBILE A GIORNO, PIASTRA CM.110,5X65 - 3 ZONE DI COTTURA (INCLUSA 1 TESTATA CHIUSURA PIANO MOD.TPA-9)**
0906123F

EN Electric Fry-top 1/3 grooved + 2/3 smooth chromed griddle SUPERCHROME (Moca Approved), on open cabinet, plate cm.110,5x65 - 3 cooking areas (included 1 Head end filler strip mod.TPA-9) • **DE** Griddleplatte elektrische 1/3 gerillt + 2/3 glatt hartverchromt SUPERCHROME (Moca Approved), mit offenem Unterbau, platte cm.110,5x65 - 3 Heizzonen (inbegriffen 1 Abschluss-Element mod.TPA-9) • **FR** Plaque électriques 1/3 nervurée + 2/3 lisse chromée SUPERCHROME (Moca Approved), sur armoire ouvert, plaque cm.110,5x65 - 3 zones de cuisson (inclus 1 Élément de jonction top mod.TPA-9) • **ES** Fry-top eléctrico 1/3 estriado + 2/3 liso cromado SUPERCHROME (Moca Approved), sobre mueble abierto, plancha cm.110,5x65 - 3 zonas de cocción (incluida 1 Chapa de cierre para top mod.TPA-9)
cm. 120x 90x 90h

⚡ 22,5 kW _____ **6.888,00**
400V~3N _____ 186 / 1,32
50/60 Hz _____



FTL-916ET **FRY-TOP ELETTRICO LISCIO, SU MOBILE A GIORNO, PIASTRA CM.150,5X65 - 4 ZONE DI COTTURA (INCLUSA 1 TESTATA CHIUSURA PIANO MOD.TPA-9)**
09061631

EN Electric Fry-top smooth griddle, on open cabinet, plate cm.150,5x65 - 4 cooking areas (included 1 Head end filler strip mod.TPA-9) • **DE** Griddleplatte elektrische glatt, mit offenem Unterbau, platte cm.150,5x65 - 4 Heizzonen (inbegriffen 1 Abschluss-Element mod.TPA-9) • **FR** Plaque électriques lisse, sur armoire ouvert, plaque cm.150,5x65 - 4 zones de cuisson (inclus 1 Élément de jonction top mod.TPA-9) • **ES** Fry-top eléctrico liso, sobre mueble abierto, plancha cm.150,5x65 - 4 zonas de cocción (incluida 1 Chapa de cierre para top mod.TPA-9)
cm. 160x 90x 90h



⚡ 30 kW _____ **7.646,00**
400V~3N _____ 256 / 1,76
50/60 Hz _____

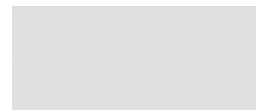

FRY-TOP ELETTRICI

MOD. _____
COD. _____

DESCRIZIONE/DESCRIPTION/BEZEICHNUNG/DESCRIPTION/DESCRIPCIÓN
DIMENSIONI/DIMENSIONS/ABMESSUNGEN/DIMENSIONS/DIMENSIONES

POTENZA/POWER/LEISTUNG/PUISSANCE/POTENCIA
VOLTAGGIO/VOLTAGE/SPANNUNG/VOLTAGE/VOLTAJE

⚡ kW
kcal/h

⚡ kW
V~
Hz

PREZZO/PRICE
PREIS/PRIX/PRECIO
KG / M³



FTL-916ETS
09061634

FRY-TOP ELETTRICO LISCIO CROMATO SUPERCHROME (MOCA APPROVED), SU MOBILE A GIORNO, PIASTRA CM.150,5X65 - 4 ZONE DI COTTURA (INCLUSA 1 TESTATA CHIUSURA PIANO MOD.TPA-9)

EN Electric Fry-top smooth chromed griddle SUPERCHROME (Moca Approved), on open cabinet, plate cm.150,5x65 - 4 cooking areas (included 1 Head end filler strip mod.TPA-9) • **DE** Griddleplatte elektrische glatt hartverchromt SUPERCHROME (Moca Approved), mit offenem Unterbau, platte cm.150,5x65 - 4 Heizzonen (inbegriffen 1 Abschluss-Element mod.TPA-9) • **FR** Plaque électriques lisse chromée SUPERCHROME (Moca Approved), sur armoire ouvert, plaque cm.150,5x65 - 4 zones de cuisson (inclus 1 Élément de jonction top mod.TPA-9) • **ES** Fry-top eléctrico liso cromado SUPERCHROME (Moca Approved), sobre mueble abierto, plancha cm.150,5x65 - 4 zonas de cocción (incluida 1 Chapa de cierre para top mod.TPA-9)
cm. 160x 90x 90h



⚡ 30 kW
400V~3N
50/60 Hz

8.721,00
256 / 1,76

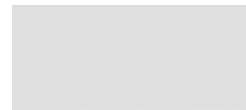

FTL-94G
09230451

FRY-TOP GAS LISCIO, SU MOBILE A GIORNO, PIASTRA CM.36X68 (INCLUSA 1 TESTATA CHIUSURA PIANO MOD.TPA-9)

EN Gas Fry-top smooth griddle, on open cabinet, plate cm.36x68 (included 1 Head end filler strip mod.TPA-9) • **DE** Gas-griddleplatte glatt, mit offenem Unterbau, platte cm.36x68 (inbegriffen 1 Abschluss-Element mod.TPA-9) • **FR** Plaque gaz lisse, sur armoire ouvert, plaque cm.36x68 (inclus 1 Élément de jonction top mod.TPA-9) • **ES** Fry-top gas liso, sobre mueble abierto, plancha cm.36x68 (incluida 1 Chapa de cierre para top mod.TPA-9)
cm. 40x 90x 90h



⚡ 9 kW
7.740 kcal/h

2.540,00
81 / 0,46



FTL-94GS
09230454

FRY-TOP GAS LISCIO CROMATO SUPERCHROME (MOCA APPROVED), SU MOBILE A GIORNO, PIASTRA CM.36X68 (INCLUSA 1 TESTATA CHIUSURA PIANO MOD.TPA-9)

EN Gas Fry-top smooth chromed griddle SUPERCHROME (Moca Approved), on open cabinet, plate cm.36x68 (included 1 Head end filler strip mod.TPA-9) • **DE** Gas-griddleplatte glatt hartverchromt SUPERCHROME (Moca Approved), mit offenem Unterbau, platte cm.36x68 (inbegriffen 1 Abschluss-Element mod.TPA-9) • **FR** Plaque gaz lisse chromée SUPERCHROME (Moca Approved), sur armoire ouvert, plaque cm.36x68 (inclus 1 Élément de jonction top mod.TPA-9) • **ES** Fry-top gas liso cromado SUPERCHROME (Moca Approved), sobre mueble abierto, plancha cm.36x68 (incluida 1 Chapa de cierre para top mod.TPA-9)
cm. 40x 90x 90h

⚡ 9 kW
7.740 kcal/h

3.046,00
81 / 0,46



FTL-94GSS
09230450

FRY-TOP GAS LISCIO CROMO LUCIDO, SU MOBILE A GIORNO, PIASTRA CM.36X68 (INCLUSA 1 TESTATA CHIUSURA PIANO MOD.TPA-9)

EN Gas Fry-top smooth POLISHED CHROME, on open cabinet, plate cm.36x68 (included 1 Head end filler strip mod.TPA-9) • **DE** Gas-griddleplatte glatt POLIERTEM CHROM, mit offenem Unterbau, platte cm.36x68 (inbegriffen 1 Abschluss-Element mod.TPA-9) • **FR** Plaque gaz lisse CHROME POLI, sur armoire ouvert, plaque cm.36x68 (inclus 1 Élément de jonction top mod.TPA-9) • **ES** Fry-top gas liso CROMO PULIDO, sobre mueble abierto, plancha cm.36x68 (incluida 1 Chapa de cierre para top mod.TPA-9)
cm. 40x 90x 90h

⚡ 9 kW
7.740 kcal/h

3.046,00
81 / 0,46



FTR-94G
09230453

FRY-TOP GAS RIGATO, SU MOBILE A GIORNO, PIASTRA CM.36X68 (INCLUSA 1 TESTATA CHIUSURA PIANO MOD.TPA-9)

EN Gas Fry-top grooved griddle, on open cabinet, plate cm.36x68 (included 1 Head end filler strip mod.TPA-9) • **DE** Gas-griddleplatte gerillt, mit offenem Unterbau, platte cm.36x68 (inbegriffen 1 Abschluss-Element mod.TPA-9) • **FR** Plaque gaz nervurée, sur armoire ouvert, plaque cm.36x68 (inclus 1 Élément de jonction top mod.TPA-9) • **ES** Fry-top gas estriado, sobre mueble abierto, plancha cm.36x68 (incluida 1 Chapa de cierre para top mod.TPA-9)
cm. 40x 90x 90h



⚡ 9 kW
7.740 kcal/h

2.719,00
81 / 0,46



FRY-TOP A GAS

MOD. _____
COD. _____

DESCRIZIONE/DESCRIPTION/BEZEICHNUNG/DESCRIPTION/DESCRIPCIÓN
DIMENSIONI/DIMENSIONS/ABMESSUNGEN/DIMENSIONS/DIMENSIONES

POTENZA/POWER/LEISTUNG/PUISSANCE/POTENCIA
VOLTAGGIO/VOLTAGE/SPANNUNG/VOLTAGE/VOLTAJE

⚡ kW
kcal/h

⚡ kw
V~
Hz

PREZZO/PRICE
PREIS/PRIX/PRECIO
KG / M³



FTR-94GS
09230456

FRY-TOP GAS RIGATO CROMATO SUPERCHROME (MOCA APPROVED), SU MOBILE A GIORNO, PIASTRA CM.36X68 (INCLUSA 1 TESTATA CHIUSURA PIANO MOD.TPA-9)

EN Gas Fry-top grooved chromed griddle SUPERCHROME (Moca Approved), on open cabinet, plate cm.36x68 (included 1 Head end filler strip mod.TPA-9) • **DE** Gas-griddleplatte gerillt hartverchromt SUPERCHROME (Moca Approved), mit offenem Unterbau, platte cm.36x68 (inbegriffen 1 Abschluss-Element mod.TPA-9) • **FR** Plaque gaz nervurée chromée SUPERCHROME (Moca Approved), sur armoire ouvert, plaque cm.36x68 (inclus 1 Élément de jonction top mod.TPA-9) • **ES** Fry-top gas estriado cromado SUPERCHROME (Moca Approved), sobre mueble abierto, plancha cm.36x68 (incluida 1 Chapa de cierre para top mod.TPA-9)

cm. 40x 90x 90h



⚡ 9 kW
7.740 kcal/h

3.225,00
81 / 0,46

FTL-98G
09230851

FRY-TOP GAS LISCIO, SU MOBILE A GIORNO, PIASTRA CM.76X68 - 2 ZONE DI COTTURA (INCLUSA 1 TESTATA CHIUSURA PIANO MOD.TPA-9)

EN Gas Fry-top smooth griddle, on open cabinet, plate cm.76x68 - 2 cooking areas (included 1 Head end filler strip mod.TPA-9) • **DE** Gas-griddleplatte glatt, mit offenem Unterbau, platte cm.76x68 - 2 Heizzonen (inbegriffen 1 Abschluss-Element mod.TPA-9) • **FR** Plaque gaz lisse, sur armoire ouvert, plaque cm.76x68 - 2 zones de cuisson (inclus 1 Élément de jonction top mod.TPA-9) • **ES** Fry-top gas liso, sobre mueble abierto, plancha cm.76x68 - 2 zonas de cocción (incluida 1 Chapa de cierre para top mod.TPA-9)

cm. 80x 90x 90h



⚡ 18 kW
15.480 kcal/h

3.884,00
134 / 0,89

FTL-98GS
09230854

FRY-TOP GAS LISCIO CROMATO SUPERCHROME (MOCA APPROVED), SU MOBILE A GIORNO, PIASTRA CM.76X68 - 2 ZONE DI COTTURA (INCLUSA 1 TESTATA CHIUSURA PIANO MOD.TPA-9)

EN Gas Fry-top smooth chromed griddle SUPERCHROME (Moca Approved), on open cabinet, plate cm.76x68 - 2 cooking areas (included 1 Head end filler strip mod.TPA-9) • **DE** Gas-griddleplatte glatt hartverchromt SUPERCHROME (Moca Approved), mit offenem Unterbau, platte cm.76x68 - 2 Heizzonen (inbegriffen 1 Abschluss-Element mod.TPA-9) • **FR** Plaque gaz lisse chromée SUPERCHROME (Moca Approved), sur armoire ouvert, plaque cm.76x68 - 2 zones de cuisson (inclus 1 Élément de jonction top mod.TPA-9) • **ES** Fry-top gas liso cromado SUPERCHROME (Moca Approved), sobre mueble abierto, plancha cm.76x68 - 2 zonas de cocción (incluida 1 Chapa de cierre para top mod.TPA-9)

cm. 80x 90x 90h

⚡ 18 kW
15.480 kcal/h

4.775,00
134 / 0,89

FTL-98GSS
09230850

FRY-TOP GAS LISCIO CROMO LUCIDO, SU MOBILE A GIORNO, PIASTRA CM.76X68 - 2 ZONE DI COTTURA (INCLUSA 1 TESTATA CHIUSURA PIANO MOD.TPA-9)

EN Gas Fry-top smooth POLISHED CHROME, on open cabinet, plate cm.76x68 - 2 cooking areas (included 1 Head end filler strip mod.TPA-9) • **DE** Gas-griddleplatte glatt POLIERTEM CHROM, mit offenem Unterbau, platte cm.76x68 - 2 Heizzonen (inbegriffen 1 Abschluss-Element mod.TPA-9) • **FR** Plaque gaz lisse CHROME POLI, sur armoire ouvert, plaque cm.76x68 - 2 zones de cuisson (inclus 1 Élément de jonction top mod.TPA-9) • **ES** Fry-top gas liso CROMO PULIDO, sobre mueble abierto, plancha cm.76x68 - 2 zonas de cocción (incluida 1 Chapa de cierre para top mod.TPA-9)

cm. 80x 90x 90h

⚡ 18 kW
15.480 kcal/h

4.775,00
134 / 0,89

FTLR-98G
09230852

FRY-TOP GAS 1/2 RIGATO + 1/2 LISCIO, SU MOBILE A GIORNO, PIASTRA CM.76X68 - 2 ZONE DI COTTURA (INCLUSA 1 TESTATA CHIUSURA PIANO MOD.TPA-9)

EN Gas Fry-top 1/2 grooved + 1/2 smooth, on open cabinet, plate cm.76x68 - 2 cooking areas (included 1 Head end filler strip mod.TPA-9) • **DE** Gas-griddleplatte 1/2 gerillt + 1/2 glatt, mit offenem Unterbau, platte cm.76x68 - 2 Heizzonen (inbegriffen 1 Abschluss-Element mod.TPA-9) • **FR** Plaque gaz 1/2 nervurée + 1/2 lisse, sur armoire ouvert, plaque cm.76x68 - 2 zones de cuisson (inclus 1 Élément de jonction top mod.TPA-9) • **ES** Fry-top gas 1/2 estriado + 1/2 liso, sobre mueble abierto, plancha cm.76x68 - 2 zonas de cocción (incluida 1 Chapa de cierre para top mod.TPA-9)

cm. 80x 90x 90h



⚡ 18 kW
15.480 kcal/h

4.065,00
134 / 0,89

MOD. _____
COD. _____

DESCRIZIONE/DESCRIPTION/BEZEICHNUNG/DESCRIPTION/DESCRIPCIÓN
DIMENSIONI/DIMENSIONS/ABMESSUNGEN/DIMENSIONS/DIMENSIONES

POTENZA/POWER/LEISTUNG/PUISSANCE/POTENCIA
VOLTAGGIO/VOLTAGE/SPANNUNG/VOLTAGE/VOLTAJE

⚡ $\frac{kW}{kcal/h}$ $\frac{V}{Hz}$

PREZZO/PRICE
PREIS/PRIX/PRECIO
KG / M³



FTLR-98GS
09230855

FRY-TOP GAS 1/2 RIGATO + 1/2 LISCIO CROMATO SUPERCHROME (MOCA APPROVED), SU MOBILE A GIORNO, PIASTRA CM.76X68 - 2 ZONE DI COTTURA (INCLUSA 1 TESTATA CHIUSURA PIANO MOD.TPA-9)

EN Gas Fry-top 1/2 grooved + 1/2 smooth chromed griddle SUPERCHROME (Moca Approved), on open cabinet, plate cm.76x68 - 2 cooking areas (included 1 Head end filler strip mod.TPA-9) • **DE** Gas-griddleplatte 1/2 gerillt + 1/2 glatt hartverchromt SUPERCHROME (Moca Approved), mit offenem Unterbau, platte cm.76x68 - 2 Heizzonen (inbegriffen 1 Abschluss-Element mod.TPA-9) • **FR** Plaque gaz 1/2 nervurée + 1/2 lisse chromée SUPERCHROME (Moca Approved), sur armoire ouvert, plaque cm.76x68 - 2 zones de cuisson (inclus 1 Élément de jonction top mod.TPA-9) • **ES** Fry-top gas 1/2 estriado + 1/2 liso cromado SUPERCHROME (Moca Approved), sobre mueble abierto, plancha cm.76x68 - 2 zonas de cocción (incluida 1 Chapa de cierre para top mod.TPA-9)

cm. 80x 90x 90h



⚡ $\frac{18 kW}{15.480 kcal/h}$ **4.998,00**
134 / 0,89



FTR-98G
09230853

FRY-TOP GAS RIGATO, SU MOBILE A GIORNO, PIASTRA CM.76X68 - 2 ZONE DI COTTURA (INCLUSA 1 TESTATA CHIUSURA PIANO MOD.TPA-9)

EN Gas Fry-top grooved griddle, on open cabinet, plate cm.76x68 - 2 cooking areas (included 1 Head end filler strip mod.TPA-9) • **DE** Gas-griddleplatte gerillt, mit offenem Unterbau, platte cm.76x68 - 2 Heizzonen (inbegriffen 1 Abschluss-Element mod.TPA-9) • **FR** Plaque gaz nervurée, sur armoire ouvert, plaque cm.76x68 - 2 zones de cuisson (inclus 1 Élément de jonction top mod.TPA-9) • **ES** Fry-top gas estriado, sobre mueble abierto, plancha cm.76x68 - 2 zonas de cocción (incluida 1 Chapa de cierre para top mod.TPA-9)

cm. 80x 90x 90h



⚡ $\frac{18 kW}{15.480 kcal/h}$ **4.254,00**
134 / 0,89



FTR-98GS
09230856

FRY-TOP GAS RIGATO CROMATO SUPERCHROME (MOCA APPROVED), SU MOBILE A GIORNO, PIASTRA CM.76X68 - 2 ZONE DI COTTURA (INCLUSA 1 TESTATA CHIUSURA PIANO MOD.TPA-9)

EN Gas Fry-top grooved chromed griddle SUPERCHROME (Moca Approved), on open cabinet, plate cm.76x68 - 2 cooking areas (included 1 Head end filler strip mod.TPA-9) • **DE** Gas-griddleplatte gerillt hartverchromt SUPERCHROME (Moca Approved), mit offenem Unterbau, platte cm.76x68 - 2 Heizzonen (inbegriffen 1 Abschluss-Element mod.TPA-9) • **FR** Plaque gaz nervurée chromée SUPERCHROME (Moca Approved), sur armoire ouvert, plaque cm.76x68 - 2 zones de cuisson (inclus 1 Élément de jonction top mod.TPA-9) • **ES** Fry-top gas estriado cromado SUPERCHROME (Moca Approved), sobre mueble abierto, plancha cm.76x68 - 2 zonas de cocción (incluida 1 Chapa de cierre para top mod.TPA-9)

cm. 80x 90x 90h

⚡ $\frac{18 kW}{15.480 kcal/h}$ **5.222,00**
134 / 0,89



FTL-912G
0923125B

FRY-TOP GAS LISCIO, SU MOBILE A GIORNO, PIASTRA CM.110,5X65 - 3 ZONE DI COTTURA (INCLUSA 1 TESTATA CHIUSURA PIANO MOD.TPA-9)

EN Gas Fry-top smooth griddle, on open cabinet, plate cm.110,5x65 - 3 cooking areas (included 1 Head end filler strip mod.TPA-9) • **DE** Gas-griddleplatte glatt, mit offenem Unterbau, platte cm.110,5x65 - 3 Heizzonen (inbegriffen 1 Abschluss-Element mod.TPA-9) • **FR** Plaque gaz lisse, sur armoire ouvert, plaque cm.110,5x65 - 3 zones de cuisson (inclus 1 Élément de jonction top mod.TPA-9) • **ES** Fry-top gas liso, sobre mueble abierto, plancha cm.110,5x65 - 3 zonas de cocción (incluida 1 Chapa de cierre para top mod.TPA-9)

cm. 120x 90x 90h



⚡ $\frac{27 kW}{23.220 kcal/h}$ **6.126,00**
198 / 1,32



MOD. _____
COD. _____

DESCRIZIONE/DESCRIPTION/BEZEICHNUNG/DESCRIPTION/DESCRIPCIÓN
DIMENSIONI/DIMENSIONS/ABMESSUNGEN/DIMENSIONS/DIMENSIONES

POTENZA/POWER/LEISTUNG/PUISSANCE/POTENCIA
VOLTAGGIO/VOLTAGE/SPANNUNG/VOLTAGE/VOLTAJE

⚡ kW
kcal/h

⚡ kw
V~
Hz

PREZZO/PRICE
PREIS/PRIX/PRECIO
KG / M³



FTL-912GS
0923125E

FRY-TOP GAS LISCIO CROMATO SUPERCHROME (MOCA APPROVED), SU MOBILE A GIORNO, PIASTRA CM.110,5X65 - 3 ZONE DI COTTURA (INCLUSA 1 TESTATA CHIUSURA PIANO MOD.TPA-9)

EN Gas Fry-top smooth chromed griddle SUPERCHROME (Moca Approved), on open cabinet, plate cm.110,5x65 - 3 cooking areas (included 1 Head end filler strip mod.TPA-9) • DE Gas-griddleplatte glatt hartverchromt SUPERCHROME (Moca Approved), mit offenem Unterbau, platte cm.110,5x65 - 3 Heizzonen (inbegriffen 1 Abschluss-Element mod.TPA-9) • FR Plaque gaz lisse chromée SUPERCHROME (Moca Approved), sur armoire ouvert, plaque cm.110,5x65 - 3 zones de cuisson (inclus 1 Élément de jonction top mod.TPA-9) • ES Fry-top gas liso cromado SUPERCHROME (Moca Approved), sobre mueble abierto, plancha cm.110,5x65 - 3 zonas de cocción (incluida 1 Chapa de cierre para top mod.TPA-9)

cm. 120x 90x 90h



⚡ 27 kW
23.220 kcal/h

6.983,00
198 / 1,32

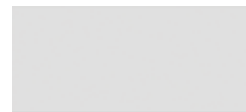

FTLR-912G
0923125C

FRY-TOP GAS 1/3 RIGATO + 2/3 LISCIO, SU MOBILE A GIORNO, PIASTRA CM.110,5X65 - 3 ZONE DI COTTURA (INCLUSA 1 TESTATA CHIUSURA PIANO MOD.TPA-9)

EN Gas Fry-top 1/3 grooved + 2/3 smooth, on open cabinet, plate cm.110,5x65 - 3 cooking areas (included 1 Head end filler strip mod.TPA-9) • DE Gas-griddleplatte 1/3 gerillt + 2/3 glatt, mit offenem Unterbau, platte cm.110,5x65 - 3 Heizzonen (inbegriffen 1 Abschluss-Element mod.TPA-9) • FR Plaque gaz 1/3 nervurée + 2/3 lisse, sur armoire ouvert, plaque cm.110,5x65 - 3 zones de cuisson (inclus 1 Élément de jonction top mod.TPA-9) • ES Fry-top gas 1/3 estriado + 2/3 liso, sobre mueble abierto, plancha cm.110,5x65 - 3 zonas de cocción (incluida 1 Chapa de cierre para top mod.TPA-9)

cm. 120x 90x 90h



⚡ 27 kW
23.220 kcal/h

6.488,00
198 / 1,32



FTLR-912GS
0923125F

FRY-TOP GAS 1/3 RIGATO + 2/3 LISCIO CROMATO SUPERCHROME (MOCA APPROVED), SU MOBILE A GIORNO, PIASTRA CM.110,5X65 - 3 ZONE DI COTTURA (INCLUSA 1 TESTATA CHIUSURA PIANO MOD.TPA-9)

EN Gas Fry-top 1/3 grooved + 2/3 smooth chromed SUPERCHROME (Moca Approved), on open cabinet, plate cm.110,5x65 - 3 cooking areas (included 1 Head end filler strip mod.TPA-9) • DE Gas-griddleplatte 1/3 gerillt + 2/3 glatt hartverchromt SUPERCHROME (Moca Approved), mit offenem Unterbau, platte cm.110,5x65 - 3 Heizzonen (inbegriffen 1 Abschluss-Element mod.TPA-9) • FR Plaque gaz 1/3 nervurée + 2/3 lisse chromée AW770:AW833pproved), sur armoire ouvert, plaque cm.110,5x65 - 3 zones de cuisson (inclus 1 Élément de jonction top mod.TPA-9) • ES Fry-top gas 1/3 estriado + 2/3 liso cromado SUPERCHROME (Moca Approved), sobre mueble abierto, plancha cm.110,5x65 - 3 zonas de cocción (incluida 1 Chapa de cierre para top mod.TPA-9)

cm. 120x 90x 90h

⚡ 27 kW
23.220 kcal/h

7.347,00
198 / 1,32



FTL-916G
09231651

FRY-TOP GAS LISCIO, SU MOBILE A GIORNO, PIASTRA CM.150,5X65 - 4 ZONE DI COTTURA (INCLUSA 1 TESTATA CHIUSURA PIANO MOD.TPA-9)

EN Gas Fry-top smooth griddle, on open cabinet, plate cm.150,5x65 - 4 cooking areas (included 1 Head end filler strip mod.TPA-9) • DE Gas-griddleplatte glatt, mit offenem Unterbau, platte cm.150,5x65 - 4 Heizzonen (inbegriffen 1 Abschluss-Element mod.TPA-9) • FR Plaque gaz lisse, sur armoire ouvert, plaque cm.150,5x65 - 4 zones de cuisson (inclus 1 Élément de jonction top mod.TPA-9) • ES Fry-top gas liso, sobre mueble abierto, plancha cm.150,5x65 - 4 zonas de cocción (incluida 1 Chapa de cierre para top mod.TPA-9)

cm. 160x 90x 90h



⚡ 36 kW
30.960 kcal/h

7.777,00
266 / 1,76



MOD. _____
COD. _____

DESCRIZIONE/DESCRIPTION/BEZEICHNUNG/DESCRIPTION/DESCRIPCIÓN
DIMENSIONI/DIMENSIONS/ABMESSUNGEN/DIMENSIONS/DIMENSIONES

POTENZA/POWER/LEISTUNG/PUISSANCE/POTENCIA
VOLTAGGIO/VOLTAGE/SPANNUNG/VOLTAGE/VOLTAJE

⚡ 36 kW
30.960 kcal/h

PREZZO/PRICE
PREIS/PRIX/PRECIO
KG / M³



FTL-916GS
09231654

FRY-TOP GAS LISCIO CROMATO SUPERCHROME (MOCA APPROVED), SU MOBILE A GIORNO, PIASTRA CM. 150,5X65 - 4 ZONE DI COTTURA (INCLUSA 1 TESTATA CHIUSURA PIANO MOD.TPA-9)

EN Gas Fry-top smooth chromed griddle SUPERCHROME (Moca Approved), on open cabinet, plate cm. 150,5x65 - 4 cooking areas (included 1 Head end filler strip mod.TPA-9) • **DE** Gas-griddleplatte glatt hartverchromt SUPERCHROME (Moca Approved), mit offenem Unterbau, platte cm. 150,5x65 - 4 Heizzonen (inbegriffen 1 Abschluss-Element mod.TPA-9) • **FR** Plaque gaz lisse chromée SUPERCHROME (Moca Approved), sur armoire ouvert, plaque cm. 150,5x65 - 4 zones de cuisson (inclus 1 Élément de jonction top mod.TPA-9) • **ES** Fry-top gas liso cromado SUPERCHROME (Moca Approved), sobre mueble abierto, plancha cm. 150,5x65 - 4 zonas de cocción (incluida 1 Chapa de cierre para top mod.TPA-9)

cm. 160x 90x 90h



⚡ 36 kW
30.960 kcal/h

8.890,00
266 / 1,76

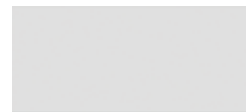

CWK-94ET
09080431

GRIGLIA CONTACT SU MOBILE A GIORNO - COTTURA DIRETTA SU RESISTENZA IN ACCIAIO INOX CM. 27X63 RIBALTABILE (INCLUSA 1 TESTATA CHIUSURA PIANO MOD. TPA-9)

EN CONTACT Grill threephase on open cabinet - rotatable stainless steel grill cm. 27x63 (included 1 Head end filler strip mod.TPA-9) • **DE** Wurstbrater dreiphasig KONTAKT mit offenem Unterbau - Drehbaren Heizelement aus Edelstahl cm. 27x63 (inbegriffen 1 Abschluss-Element mod.TPA-9) • **FR** Grillade triphase CONTACT sur armoire ouvert- Grille inox rotatif cm 27x63 (inclus 1 Élément de jonction top mod.TPA-9) • **ES** Parrilla trifásico CONTACT sobre mueble abierto - Parrilla giratoria de acero inox cm 27x63 (incluida 1 Chapa de cierre para top mod.TPA-9)

cm. 40x 90x 90h



⚡ 5,415 kW
400V~3N
50/60 Hz

3.489,00
69 / 0,46

CWK-98ET
09080831

GRIGLIA CONTACT SU MOBILE A GIORNO - COTTURA DIRETTA SU RESISTENZA IN ACCIAIO INOX CM. 55X63 RIBALTABILE - 2 ZONE DI COTTURA (INCLUSA 1 TESTATA CHIUSURA PIANO MOD.TPA-9)

EN CONTACT Grill threephase on open cabinet - rotatable stainless steel grill cm. 55x63 - 2 cooking areas (included 1 Head end filler strip mod.TPA-9) • **DE** Wurstbrater dreiphasig KONTAKT mit offenem Unterbau - Drehbaren Heizelement aus Edelstahl cm. 55x63 - 2 Heizzonen (inbegriffen 1 Abschluss-Element mod.TPA-9) • **FR** Grillade triphase CONTACT sur armoire ouvert- Grille inox rotatif cm 55x63 - 2 zones de cuisson (inclus 1 Élément de jonction top mod.TPA-9) • **ES** Parrilla trifásico CONTACT sobre mueble abierto - Parrilla giratoria de acero inox cm 55x63 - 2 zonas de cocción (incluida 1 Chapa de cierre para top mod.TPA-9)

cm. 80x 90x 90h



⚡ 10,83 kW
400V~3N
50/60 Hz

4.785,00
105 / 0,89

CW-94ET
09080430

GRIGLIA TRIFASE SU MOBILE A GIORNO GRIGLIA IN ACCIAIO INOX CM. 38X66 REGOLABILE (INCLUSA 1 TESTATA CHIUSURA PIANO MOD.TPA-9)

EN Grill threephase on open cabinet Stainless steel adjustable grill cm. 38x66 (included 1 Head end filler strip mod.TPA-9) • **DE** Wurstbrater dreiphasig mit offenem Unterbau Einstellbarer Rost aus Nirosta cm. 38x66 (inbegriffen 1 Abschluss-Element mod.TPA-9) • **FR** Grillade triphase sur armoire ouvert Grille réglable en acier inox cm 38x66 (inclus 1 Élément de jonction top mod.TPA-9) • **ES** Parrilla trifásico sobre mueble abierto Parrilla de acero inox regulable cm 38x66 (incluida 1 Chapa de cierre para top mod.TPA-9)

cm. 40x 90x 90h



⚡ 7,8 kW
400V~3N
50/60 Hz

2.745,00
71 / 0,46

CW-98ET
09080830

GRIGLIA TRIFASE SU MOBILE A GIORNO N. 2 GRIGLIE IN ACCIAIO INOX CM. 38X66 REGOLABILI 2 ZONE DI COTTURA (INCLUSA 1 TESTATA CHIUSURA PIANO MOD.TPA-9)

EN Grill threephase on open cabinet - N. 2 stainless steel adjustable grills cm. 38x66 - 2 cooking areas (included 1 Head end filler strip mod.TPA-9) • **DE** Wurstbrater dreiphasig mit offenem Unterbau - N. 2 einstellbarer Roste aus Nirosta cm. 38x66 - 2 Heizzonen (inbegriffen 1 Abschluss-Element mod.TPA-9) • **FR** Grillade triphase sur armoire ouvert - N. 2 grilles réglable en acier inox cm. 38x66 - 2 zones de cuisson (inclus 1 Élément de jonction top mod.TPA-9) • **ES** Parrilla trifásico sobre mueble abierto - N. 2 parrillas de acero inox regulable cm 38x66 - 2 zonas de cocción (incluida 1 Chapa de cierre para top mod.TPA-9)

cm. 80x 90x 90h



⚡ 15,6 kW
400V~3N
50/60 Hz

4.051,00
109 / 0,89

GRIGLIE PIETRA LAVICA A GAS

MOD. _____
COD. _____

DESCRIZIONE/DESCRIPTION/BEZEICHNUNG/DESCRIPTION/DESCRIPCIÓN
DIMENSIONI/DIMENSIONS/ABMESSUNGEN/DIMENSIONS/DIMENSIONES

POTENZA/POWER/LEISTUNG/PUISSANCE/POTENCIA
VOLTAGGIO/VOLTAGE/SPANNUNG/VOLTAGE/VOLTAJE

⚡ kW
kcal/h

PREZZO/PRICE
PREIS/PRIX/PRECIO
KG / M³



CW-94G
09250450

GRIGLIA GAS-PIETRALAVICA SU MOBILE A GIORNO GRIGLIA IN ACCIAIO INOX CM. 38X66 REGOLABILE (INCLUSA 1 TESTATA CHIUSURA PIANO MOD.TPA-9)

EN Charcoal grill gas on open cabinet - Stainless steel adjustable grill cm. 38x66 (included 1 Head end filler strip mod.TPA-9) • **DE** Gas-Lavasteingrill mit offenem Unterbau - Einstellbarer Rost aus Nirosta cm. 38x66 (inbegriffen 1 Abschluss-Element mod.TPA-9) • **FR** Grille a gaz en pierre de lave sur armoire ouvert - Grille réglable en acier inox cm. 38x66 (inclus 1 Elément de jonction top mod.TPA-9) • **ES** Parrilla a gas piedra lávica sobre mueble abierto - Parrilla de acero inox regulable 38x66 cm (incluida 1 Chapa de cierre para top mod.TPA-9)
cm. 40x 90x 90h



⚡ 12 kW
20.320 kcal/h

2.673,00
77 / 0,46

CW-98G
09250850

GRIGLIA GAS-PIETRALAVICA SU MOBILE A GIORNO N. 2 GRIGLIE IN ACCIAIO INOX CM. 38X66 REGOLABILI 2 ZONE DI COTTURA (INCLUSA 1 TESTATA CHIUSURA PIANO MOD. TPA-9)

EN Charcoal grill gas on open cabinet - N. 2 stainless steel adjustable grills cm. 38x66 - 2 cooking areas (included 1 Head end filler strip mod. TPA-9) • **DE** Gas-Lavasteingrill mit offenem Unterbau - N. 2 einstellbarer Roste aus Nirosta cm. 38x66 - 2 Heizzonen (inbegriffen 1 Abschluss-Element mod.TPA-9) • **FR** Grille à gaz en pierre de lave sur armoire ouvert N. 2 grilles en acier inox cm 38x66 - 2 zones de cuisson (inclus 1 Elément de jonction top mod.TPA-9) • **ES** Parrilla a gas piedra lávica sobre mueble abierto N. 2 parrilla de acero inox regulable cm 38x66 - 2 zonas de coccion (incluida 1 Chapa de cierre para top mod.TPA-9)
cm. 80x 90x 90h



⚡ 24 kW
20.640 kcal/h

4.156,00
131 / 0,89

F2/8-94ET
09090432

FRIGGITRICE TRIFASE LT. 8+8 2 VASCHE CM. 14,8X35X32,7H 2 CESTI CM. 12X30X15H - FILTRO E COPERCHIO VASCA. PRODUZIONE PATATE: 12 KG/H (BACINELLA RACCOGLIOLIO ESCLUSA, VEDI MOD: BF30) (INCLUSA 1 TESTATA CHIUSURA PIANO MOD.TPA-9)

EN Fryer threephase 8+8 lts - 2 Bowls cm. 14,8x35x32,7h - 2 baskets cm. 12x30x15h. Sieve and lid for pan. Production: 12 kg/h (Drip tray excluded, see mod: BF30) (included 1 Head end filler strip mod.TPA-9) • **DE** Friteuse dreiphasig lt. 8+8 - 2 Becken cm. 14,8x35x32,7h - 2 Korb cm. 12x30x15h. Einlegesieb und Deckel für Becken. Pommes frites: 12 kg/h (Fettauffangschale ausgeschlossen, sehen mod: BF30) (inbegriffen 1 Abschluss-Element mod.TPA-9) • **FR** Friteuse triphase lt. 8+8 - 2 Cuve cm. 14,8x35x32,7h - 2 Panier cm. 12x30x15h. Filtre, couvercle pour cuve. Production de pommes frites: 12 kg/h (Bac de récupération de l'huile exclus, voir mod: BF30) (inclus 1 Elément de jonction top mod. TPA-9) • **ES** Freidoras trifásico 8+8 lt. - 2Cuba cm. 14,8x35x32,7h - 2 cesta cm. 12x30x15hh. Filtro y tapa para cuba. Prod. patatas: 12 Kg/h (bandeja recoge aceite excluida, ver mod: BF30) (incluida 1 Chapa de cierre para top mod.TPA-9)
cm. 40x 90x 90h



⚡ 12 kW
400V~3N
230V~3
50/60 Hz

3.994,00
63 / 0,46

F18-94ET
09090430

FRIGGITRICE TRIFASE LT. 18 VASCA CM. 31X34X33H 1 CESTO CM. 28X29X15H COPERCHIO VASCA - PROD. PATATE: 15 KG/H (BACINELLA RACCOGLIOLIO ESCLUSA, VEDI MOD: BF30) (INCLUSA 1 TESTATA CHIUSURA PIANO MOD.TPA-9)

EN Fryer threephase 18 lts. - Bowl cm. 31x34x33h 1 basket cm. 28x29x15h - Lid for pan - Production: 15 kg/h (Drip tray excluded, see mod: BF30) (included 1 Head end filler strip mod.TPA-9) • **DE** Friteuse dreiphasig lt. 18 - Becken cm. 31x34x33h 1 Korb cm. 28x29x15h - Deckel für Becken - Pommes frites: 15 kg/h (Fettauffangschale ausgeschlossen, sehen mod: BF30) (inbegriffen 1 Abschluss-Element mod. TPA-9) • **FR** Friteuse triphase lt. 18 - Cuve cm. 31x34x33h 1 Panier cm. 28x29x15h Couvercle pour cuve - Production de pommes frites: 15 kg/h (Bac de récupération de l'huile exclus, voir mod: BF30) (inclus 1 Elément de jonction top mod.TPA-9) • **ES** Freidoras trifásico 18 lt. - Cuba cm. 31x34x33h 1 cesta cm. 28x29x15h - Tapa para cuba Producción patatas: 15 Kg/h (bandeja recoge aceite excluida, ver mod: BF30) (incluida 1 Chapa de cierre para top mod.TPA-9)
cm. 40x 90x 90h



⚡ 15,9 kW
400V~3N
50/60 Hz

3.138,00
63 / 0,46

FRIGGITRICI ELETTRICHE

MOD. _____
COD. _____

DESCRIZIONE/DESCRIPTION/BEZEICHNUNG/DESCRIPTION/DESCRIPCIÓN
DIMENSIONI/DIMENSIONS/ABMESSUNGEN/DIMENSIONS/DIMENSIONES

POTENZA/POWER/LEISTUNG/PUISSANCE/POTENCIA
VOLTAGGIO/VOLTAGE/SPANNUNG/VOLTAGE/VOLTAJE

⚡ kW kcal/h
⚡ kW V~ Hz

PREZZO/PRICE
PREIS/PRIX/PRECIO
KG / M³



F25-94ET
09090431

FRIGGITRICE TRIFASE LT. 25 VASCA CM. 31X51X33H - 2 CESTI CM. 13,5X45X15H COPERCHIO VASCA - PROD. PATATE: 25 KG/H (BACINELLA RACCOGLIOLIO ESCLUSA, VEDI MOD: BF30) (INCLUSA 1 TESTATA CHIUSURA PIANO MOD. TPA-9)

EN Fryer threephase 25 lts. - Bowl cm. 31x51x33h 2 baskets cm. 13,5x45x15h - Lid for tank Production: 25 kg/h (Drip tray excluded, see mod: BF30) (included 1 Head end filler strip mod.TPA-9) • **DE** Friteuse dreiphasig lt. 25 - Becken cm. 31x51x33h 2 Körbe cm. 13,5x45x15h - Deckel für Becken Pommes frites: 25 kg/h (Fettauffangschale ausgeschlossen, sehen mod: BF30) (inbegriffen 1 Abschluss-Element mod. TPA-9) • **FR** Friteuse triphase lt. 25 - Cuve cm. 31x51x33h 2 Paniers cm. 13,5x45x15h - Couvercle pour cuve Production de pommes frites: 25 kg/h (Bac de récupération de l'huile exclus, voir mod: BF30) (inclus 1 Elément de jonction top mod.TPA-9) • **ES** Freidoras trifásico 25 lt. - Cuba cm. 31x51x33h 2 cestas cm. 13,5x45x15h - Tapa para cuba Producción patatas: 25 Kg/h (bandeja recoge aceite excluida, ver mod: BF30) (incluida 1 Chapa de cierre para top mod.TPA-9)
cm. 40x 90x 90h



⚡ 22 kW **3.439,00**
400V~3N 66 / 0,46
50/60 Hz

F2/18-98ET
09090830

FRIGGITRICE TRIFASE LT. 18+18 2 VASCHE CM. 31X34X33H - 2 CESTI CM. 28X29X15H 2 COPERCHI VASCHE - PROD. PATATE: 30 KG/H (BACINELLA RACCOGLIOLIO ESCLUSA, VEDI MOD: BF30) (INCLUSA 1 TESTATA CHIUSURA PIANO MOD. TPA-9)

EN Fryer threephase 18+18 lts - 2 pans cm. 31x34x33h 2 baskets cm. 28x29x15h - 2 lids for tank Production: 30 kg/h (Drip tray excluded, see mod: BF30) (included 1 Head end filler strip mod.TPA-9) • **DE** Friteuse dreiphasig lt. 18+18 - 2 Becken cm. 31x34x33h 2 Körbe cm. 28x29x15h - 2 Deckel für Becken Pommes frites: 30 kg/h (Fettauffangschale ausgeschlossen, sehen mod: BF30) (inbegriffen 1 Abschluss-Element mod. TPA-9) • **FR** Friteuse triphase lt. 18+18 - 2 cuves cm. 31x34x33h 2 paniers cm. 28x29x15h - 2 couvercles pour cuve Production de pommes frites: 30 kg/h (Bac de récupération de l'huile exclus, voir mod: BF30) (inclus 1 Elément de jonction top mod.TPA-9) • **ES** Freidoras trifásico 18+18 lt. - 2 cubas cm. 31x34x33h 2 cestas cm. 28x29x15h - 2 tapas para cuba Producción patatas: 30 Kg/h (bandeja recoge aceite excluida, ver mod: BF30) (incluida 1 Chapa de cierre para top mod.TPA-9)
cm. 80x 90x 90h



⚡ 31,8 kW **4.980,00**
400V~3N 106 / 0,89
50/60 Hz

F2/25-98ET
09090831

FRIGGITRICE TRIFASE LT. 25+25 2 VASCHE CM. 31X51X33H - 4 CESTI CM. 13,5X45X15H 2 COPERCHI VASCHE - PROD. PATATE: 50 KG/H (BACINELLA RACCOGLIOLIO ESCLUSA, VEDI MOD: BF30) (INCLUSA 1 TESTATA CHIUSURA PIANO MOD. TPA-9)

EN Fryer threephase 25+25 lts. - 2 pans cm. 31x51x33h 4 baskets cm. 13,5x45x15h - 2 lids for tank Production: 50 kg/h (Drip tray excluded, see mod: BF30) (included 1 Head end filler strip mod.TPA-9) • **DE** Friteuse dreiphasig lt. 25+25 - 2 Becken cm. 31x51x33h 4 Körbe cm. 13,5x45x15h - 2 Deckel für Becken Pommes frites: 50 kg/h (Fettauffangschale ausgeschlossen, sehen mod: BF30) (inbegriffen 1 Abschluss-Element mod.TPA-9) • **FR** Friteuse triphase lt. 25+25 - 2 cuves cm. 31x51x33h 4 paniers cm. 13,5x45x15h - 2 couvercles pour cuve Production de pommes frites: 50 kg/h (Bac de récupération de l'huile exclus, voir mod: BF30) (inclus 1 Elément de jonction top mod.TPA-9) • **ES** Freidoras trifásico 25+25 lt. - 2 cubas cm. 31x51x33h 4 cestas cm. 13,5x45x15h - 2 tapas para cuba Producción patatas: 50 Kg/h (bandeja recoge aceite excluida, ver mod: BF30) (incluida 1 Chapa de cierre para top mod.TPA-9)
cm. 80x 90x 90h

⚡ 44 kW **5.563,00**
400V~3N 114 / 0,89
50/60 Hz

FRIGGITRICI A GAS

MOD. _____
COD. _____

DESCRIZIONE/DESCRIPTION/BEZEICHNUNG/DESCRIPTION/DESCRIPCIÓN
DIMENSIONI/DIMENSIONS/ABMESSUNGEN/DIMENSIONS/DIMENSIONES

POTENZA/POWER/LEISTUNG/PUISSANCE/POTENCIA
VOLTAGGIO/VOLTAGE/SPANNUNG/VOLTAGE/VOLTAJE

⚡ kW
kcal/h

PREZZO/PRICE
PREIS/PRIX/PRECIO
KG / M³



F2/8-94G
09260452

FRIGGITRICE GAS LT. 8+8 - 2 VASCHE CM. 15X35X36H 2 CESTI CM. 12X30X15H. FILTRO E COPERCHIO VASCA. PROD. PATATE: 12 KG/H (BACINELLA RACCOGLIOLIO ESCLUSA, VEDI MOD: BF30) (INCLUSA 1 TESTATA CHIUSURA PIANO MOD. TPA-9)

EN Gas Fryer 8+8 lts - 2 pans cm. 15x35x36h 2 baskets cm. 12x30x15h. Sieve and lid for pan. Production: 12 kg/h (Drip tray excluded, see mod: BF30) (included 1 Head end filler strip mod.TPA-9)
• DE Gas-Friteuse lt. 8+8 - 2 Becken cm. 15x35x36h 2 Körbe cm. 12x30x15h. Einlegesieb und Deckel für Becken. Pommes frites: 12 kg/h (Fettauffangschale ausgeschlossen, sehen mod: BF30) (inbegriffen 1 Abschluss-Element mod.TPA-9) **• FR** Friteuse à gaz lt. 8+8 - 2 cuves cm. 15x35x36h 2 paniers cm. 12x30x15h. Filtre, couvercle pour cuve. Production de pommes frites: 12 kg/h (Bac de récupération de l'huile exclus, voir mod: BF30) (inclus 1 Élément de jonction top mod.TPA-9)
• ES Freidoras a gas 8+8 lt. - 2 cubas cm. 15x35x36h 2 cestas cm. 12x30x15h. Filtro y tapa para cuba. Prod. patatas: 12 Kg/h (bandeja recoge aceite excluida, ver mod: BF30) (incluida 1 Chapa de cierre para top mod.TPA-9)
cm. 40x 90x 90h



⚡ 10 kW
8.600 kcal/h

4.591,00
63 / 0,46

F18-94G
09260450

FRIGGITRICE GAS LT. 18 VASCA CM. 24X51X44H - 1 CESTO CM. 21X45X15H COPERCHIO VASCA - PROD. PATATE: 15 KG/H (BACINELLA RACCOGLIOLIO ESCLUSA, VEDI MOD: BF30) (INCLUSA 1 TESTATA CHIUSURA PIANO MOD.TPA-9)

EN Gas fryer 18 lts. - Bowl cm. 24x51x44h 1 basket cm. 21x45x15h - Lid for tank Production: 15 kg/h (Drip tray excluded, see mod: BF30) (included 1 Head end filler strip mod.TPA-9) **• DE** Gas-Friteuse lt. 18 - Becken cm. 24x51x44h 1 Korb cm. 21x45x15h - Deckel für Becken Pommes frites: 15 kg/h (Fettauffangschale ausgeschlossen, sehen mod: BF30) (inbegriffen 1 Abschluss-Element mod.TPA-9) **• FR** Friteuse à gaz lt. 18 - Cuve cm. 24x51x44h 1 Panier cm. 21x45x15h - Couvercle pour cuve Production de pommes frites: 15 kg/h (Bac de récupération de l'huile exclus, voir mod: BF30) (inclus 1 Élément de jonction top mod.TPA-9) **• ES** Freidoras a gas 18 lt. - Cuba cm. 24x51x44h 1 cesta cm. 21x45x15h - Tapa para cuba Producción patatas: 15 Kg/h (bandeja recoge aceite excluida, ver mod: BF30) (incluida 1 Chapa de cierre para top mod.TPA-9)
cm. 40x 90x 90h



⚡ 15 kW
12.900 kcal/h

3.568,00
69 / 0,46

⚡ 0,005 kW
230V~
50 Hz

F25-94G
09260451

FRIGGITRICE GAS LT. 25 VASCA CM. 31X51X44H - 2 CESTI CM. 13,5X45X15H COPERCHIO VASCA - PROD. PATATE: 25 KG/H (BACINELLA RACCOGLIOLIO ESCLUSA, VEDI MOD: BF30) (INCLUSA 1 TESTATA CHIUSURA PIANO MOD.TPA-9)

EN Gas fryer 25 lts - Pan cm. 31x51x44h 2 baskets cm. 13,5x45x15h - Lid for tank Production: 25 kg/h. (Drip tray excluded, see mod: BF30) (included 1 Head end filler strip mod.TPA-9) **• DE** Gas-Friteuse lt. 25 - Becken cm. 31x51x44h 2 Körbe cm. 13,5x45x15h - Deckel für Becken Production: 25 kg/h (Fettauffangschale ausgeschlossen, sehen mod: BF30) (inbegriffen 1 Abschluss-Element mod.TPA-9) **• FR** Friteuse à gaz lt. 25 - Cuve cm. 31x51x44h 2 Paniers cm. 13,5x45x15h - Couvercle pour cuve Pommes frites: 25 kg/h (Bac de récupération de l'huile exclus, voir mod: BF30) (inclus 1 Élément de jonction top mod.TPA-9) **• ES** Freidoras a gas 25 lt. - Cuba cm. 31x51x44h 2 cestas cm. 13,5x45x15h - Tapa para cuba Producción patatas: 25 Kg/h (bandeja recoge aceite excluida, ver mod: BF30) (incluida 1 Chapa de cierre para top mod.TPA-9)
cm. 40x 90x 90h

⚡ 20 kW
17.200 kcal/h

3.877,00
75 / 0,46

⚡ 0,005 kW
230V~
50 Hz

FRIGGITRICI A GAS

MOD. _____
COD. _____

DESCRIZIONE/DESCRIPTION/BEZEICHNUNG/DESCRIPTION/DESCRIPCIÓN
DIMENSIONI/DIMENSIONS/ABMESSUNGEN/DIMENSIONS/DIMENSIONES

POTENZA/POWER/LEISTUNG/PUISSANCE/POTENCIA
VOLTAGGIO/VOLTAGE/SPANNUNG/VOLTAGE/VOLTAJE

⚡ kW _____
kcal/h _____
⚡ kW _____
V~ _____
Hz _____

PREZZO/PRICE
PREIS/PRIX/PRECIO
KG / M³



F2/18-98G
09260850

FRIGGITRICE GAS LT. 18+18 2 VASCHE CM. 24X51X44H - 2 CESTI CM. 21X45X15H 2 COPERCHI VASCHE - PROD. PATATE: 30 KG/H (BACINELLA RACCOGLIOLIO ESCLUSA, VEDI MOD: BF30) (INCLUSA 1 TESTATA CHIUSURA PIANO MOD.TPA-9)
EN Fryer gas 18+18 lts - 2 pans cm. 24x51x44h 2 baskets cm. 21x45x15h - 2 lids for tank Production: 30 kg/h (Drip tray excluded, see mod: BF30) (included 1 Head end filler strip mod.TPA-9) • **DE** Gas-Friteuse dreiphasig lt. 18+18 - 2 Becken cm. 24x51x44h 2 Körbe cm. 21x45x15h - 2 Deckel für Becken Pommes frites: 30 kg/h (Fettauffangschale ausgeschlossen, sehen mod: BF30) (inbegriffen 1 Abschluss-Element mod.TPA-9) • **FR** Friteuse à gaz lt. 18+18 - 2 cuves cm. 24x51x44h 2 paniers cm. 21x45x15h - 2 couvercles pour cuve Production de pommes frites: 30 kg/h (Bac de récupération de l'huile exclus, voir mod: BF30) (inclus 1 Élément de jonction top mod.TPA-9) • **ES** Freidoras a gas 18+18 lt. - 2 cubas cm. 24x51x44h 2 cestas cm. 21x45x15h - 2 tapas para cuba Producción patatas: 30 Kg/h (bandeja recoge aceite excluida, ver mod: BF30) (incluida 1 Chapa de cierre para top mod.TPA-9)
cm. 80x 90x 90h



⚡ 30 kW _____ **5.630,00**
25.770 kcal/h 116 / 0,89
⚡ 0,01 kW _____
230V~ _____
50 Hz _____

F2/25-98G
09260851

FRIGGITRICE GAS LT. 25+25 2 VASCHE CM. 31X51X44H - 4 CESTI CM. 13,5X45X15H 2 COPERCHI VASCHE - PROD. PATATE: 50 KG/H (BACINELLA RACCOGLIOLIO ESCLUSA, VEDI MOD: BF30) (INCLUSA 1 TESTATA CHIUSURA PIANO MOD. TPA-9)
EN Fryer gas 25+25 lts - 2 pans cm. 31x51x44h 4 baskets cm. 13,5x45x15h - 2 lids for tank Production: 50 kg/h (Drip tray excluded, see mod: BF30) (included 1 Head end filler strip mod.TPA-9) • **DE** Gas-Friteuse dreiphasig lt. 25+25 - 2 Becken cm. 31x51x44h 4 Körbe cm. 13,5x45x15h - 2 Deckel für Becken Pommes frites: 50 kg/h (Fettauffangschale ausgeschlossen, sehen mod: BF30) (inbegriffen 1 Abschluss-Element mod.TPA-9) • **FR** Friteuse à gaz lt. 25+25 - 2 cuves cm. 31x51x44h 4 paniers cm. 13,5x45x15h - 2 couvercles pour cuve Production de pommes frites: 50 kg/h (Bac de récupération de l'huile exclus, voir mod: BF30) (inclus 1 Élément de jonction top mod.TPA-9) • **ES** Freidoras a gas 25+25 lt. - 2 cubas cm. 31x51x44h 4 cestas cm. 13,5x45x15h - 2 tapas para cuba Producción patatas: 50 Kg/h (bandeja recoge aceite excluida, ver mod: BF30) (incluida 1 Chapa de cierre para top mod.TPA-9)
cm. 80x 90x 90h

⚡ 40 kW _____ **6.306,00**
34.360 kcal/h 126 / 0,89
⚡ 0,01 kW _____
230V~ _____
50 Hz _____

FRIGGITRICI ELETTRICHE DIGITALI

MOD. _____
COD. _____

DESCRIZIONE/DESCRIPTION/BEZEICHNUNG/DESCRIPTION/DESCRIPCIÓN
DIMENSIONI/DIMENSIONS/ABMESSUNGEN/DIMENSIONS/DIMENSIONES

POTENZA/POWER/LEISTUNG/PUISSANCE/POTENCIA
VOLTAGGIO/VOLTAGE/SPANNUNG/VOLTAGE/VOLTAJE

⚡ kW kcal/h
⚡ kW V~ Hz

PREZZO/PRICE
PREIS/PRIX/PRECIO
KG / M³



F18-94ETD
0915A430

FRIGGITRICE ELETTRICA ELETTRONICA CON TOUCHSCREEN 7". CONSERVAZIONE A 110 °C O PRELAVORO A 160 °C CON O SENZA MELTING. POSSIBILITÀ DI INSERIRE IN MEMORIA FINO A 100 PROGRAMMI. SENSORE PRESENZA E LIVELLO MASSIMO OLIO. VASCA 18 LITRI CM.31X34X33H - 2 CESTI CM.13,5X29X21H - FILTRO E COPERCHIO VASCA. BACINELLA RACCOLTA OLIO CON SUPPORTO SU RUOTE. PRODUZIONE PATATE: 27 KG/H (INCLUSA 1 TESTATA CHIUSURA PIANO MOD.TPA-9)

EN Electric electronic Fryer with a 7" TouchScreen. Conservation at 110 °C and preworking at 160 °C with or without Melting. Possibility to store in the memory up to 100 programs. Oil presence sensor and maximum level sensor. Bowl 18 lts cm.31x34x33h - 2 baskets cm.13,5x29x21h. Sieve and lid for pan. Oil collection basin with support on wheels. Production: 27 kg/h (included 1 Head end filler strip mod. TPA-9) • **DE** ELEKTRONISCHE ELEKTRISCHE FRITEUSE mit TouchScreen 7". Aufbewahrung bei 110 °C oder Vorbereitung bei 160 °C mit oder ohne Melting. Es können bis zu 100 Programme gespeichert werden. Anwesenheits- sowie maximaler Ölstandsensor. Becken 18 lt. cm.31x34x33h - 2 Körbe cm.13,5x29x21h. Einlegesieb und Deckel für Becken. Ölauffangbecken mit Halterung auf Rädern. Pommes frites: 27 kg/h (inbegriffen 1 Abschluss-Element mod.TPA-9) • **FR** FRITEUSE ÉLECTRIQUE ÉLECTRONIQUE à Écran tactile 7". Conservation à 110 °C ou Pré-traitement à 160 °C avec ou sans Melting. Possibilité d'enregistrer jusqu'à 100 programmes en mémoire. Capteur de présence et de niveau maximal huile. Cuve 18 lt. cm.31x34x33h - 2 Paniers cm.13,5x29x21h. Filtre, couvercle pour cuve. Bassine de collecte de l'huile avec support sur roues. Production de pommes frites: 27 kg/h (inclus 1 Élément de jonction top mod.TPA-9) • **ES** FREIDORA ELÉCTRICA ELECTRÓNICA con pantalla táctil de 7". Conservación a 110 °C o trabajo previo a 160 °C con o sin fusión. Se pueden almacenar hasta 100 programas en la memoria. Sensor de presencia y nivel máximo de aceite. Cuba de 18 litros cm. 31x34x33h - 2 cestas cm.13,5x29x21h. Filtro y tapa para cuba. Cubeta de recogida de aceite con soporte sobre ruedas. Prod. patatas: 27 Kg/h (incluida 1 Chapa de cierre para top mod.TPA-9)
cm. 40x 90x 90h



⚡ 15,95 kW
400V~3N
50/60 Hz

6.362,00
69 / 0,54

MOD. _____
COD. _____

DESCRIZIONE/DESCRIPTION/BEZEICHNUNG/DESCRIPTION/DESCRIPCIÓN
DIMENSIONI/DIMENSIONS/ABMESSUNGEN/DIMENSIONS/DIMENSIONES

POTENZA/POWER/LEISTUNG/PUISSANCE/POTENCIA
VOLTAGGIO/VOLTAGE/SPANNUNG/VOLTAGE/VOLTAJE

⚡ kW kcal/h
⚡ kW V~ Hz

PREZZO/PRICE PREIS/PRIX/PRECIO
KG / M³



F18-94ETDP 0915A431 FRIGGITRICE ELETTRICA ELETTRONICA CON TOUCHSCREEN 7". CONSERVAZIONE A 110 °C O PRELAVORO A 160 °C CON O SENZA MELTING. POSSIBILITÀ DI INSERIRE IN MEMORIA FINO A 100 PROGRAMMI. SENSORE PRESENZA E LIVELLO MASSIMO OLIO. POMPA FILTRAGGIO OLIO A CALDO MAX 180°C, PULIZIA VASCA, SVUOTAMENTO VASCA. VASCA 18 LITRI CM.31X34X33H - 2 CESTI CM.13,5X29X21H - FILTRO E COPERCHIO VASCA. BACINELLA RACCOLTA OLIO CON SUPPORTO SU RUOTE E FILTRO 5 MICRON (PZ.100 INCLUSI). PRODUZIONE PATATE: 27 KG/H (INCLUSA 1 TESTATA CHIUSURA PIANO MOD.TPA-9)

EN Electric electronic Fryer with a 7" TouchScreen. Conservation at 110 °C and preworking at 160 °C with or without Melting. Possibility to store in the memory up to 100 programs. Oil presence sensor and maximum level sensor. Pump for filter the hot oil max 180°C, Tank cleaning, Tank emptying. Bowl 18 lts cm.31x34x33h - 2 baskets cm.13,5x29x21h. Sieve and lid for pan. Oil collection basin with support on wheels with sieve 5 microns (pcs.100 included). Production: 27 kg/h (included 1 Head end filler strip mod.TPA-9) • **DE** ELEKTRONISCHE ELEKTRISCHE FRITEUSE mit TouchScreen 7". Aufbewahrung bei 110 °C oder Vorbearbeitung bei 160 °C mit oder ohne Melting. Es können bis zu 100 Programme gespeichert werden. Anwesenheits- sowie maximaler Ölstandsensoren. Heißölfilterpumpe max 180°C, Tankreinigung, Tankentleerung. Becken 18 lt. cm.31x34x33h - 2 Körbe cm.13,5x29x21h. Einlegesieb und Deckel für Becken. Ölauffangbecken mit Halterung auf Rädern und 5-Mikron-Filter (Stk.100 inbegriffen). Pommes frites: 27 kg/h (inbegriffen 1 Abschluss-Element mod.TPA-9) • **FR** FRITEUSE ÉLECTRIQUE ÉLECTRONIQUE à Écran tactile 7". Conservation à 110 °C ou Pré-traitement à 160 °C avec ou sans Melting. Possibilité d'enregistrer jusqu'à 100 programmes en mémoire. Capteur de présence et de niveau maximal huile. Pompe filtration huile à chaud max 180°C, nettoyage cuve, vidange cuve. Cuve 18 lt. cm.31x34x33h - 2 Paniers cm.13,5x29x21h. Filtre, couvercle pour cuve. Bassine de collecte de l'huile avec support sur roues et filtre 5 microns (pcs.100 inclus). Production de pommes frites: 27 kg/h (inclus 1 Élément de jonction top mod.TPA-9) • **ES** FREIDORA ELÉCTRICA ELECTRÓNICA con pantalla táctil de 7". Conservación a 110 °C o trabajo previo a 160 °C con o sin fusión. Se pueden almacenar hasta 100 programas en la memoria. Sensor de presencia y nivel máximo de aceite. Bomba de filtrado de aceite caliente, máximo 180 °C, limpieza del tanque, vaciado del tanque. Cuba de 18 litros cm. 31x34x33h - 2 cestas cm.13,5x29x21h. Filtro y tapa para cuba. Cubeta de recogida de aceite con soporte sobre ruedas y filtro de 5 micrones (pz.100 incluida). Prod. patatas: 27 Kg/h (incluida 1 Chapa de cierre para top mod.TPA-9)

cm. 40x 90x 90h



⚡ 16,2 kW 9.746,00
400V~3N 79 / 0,54
50/60 Hz

FRIGGITRICI ELETTRICHE DIGITALI

MOD. _____
COD. _____

DESCRIZIONE/DESCRIPTION/BEZEICHNUNG/DESCRIPTION/DESCRIPCIÓN
DIMENSIONI/DIMENSIONS/ABMESSUNGEN/DIMENSIONS/DIMENSIONES

POTENZA/POWER/LEISTUNG/PUISSANCE/POTENCIA
VOLTAGGIO/VOLTAGE/SPANNUNG/VOLTAGE/VOLTAJE

⚡ kW
kcal/h

⚡ kw
V~
Hz

PREZZO/PRICE
PREIS/PRIX/PRECIO
KG / M³



F18-94ETDPS FRIGGITRICE ELETTRICA ELETTRONICA CON TOUCHSCREEN
0915A432 **7". CONSERVAZIONE A 110 °C O PRELAVORO A 160 °C CON O SENZA MELTING. POSSIBILITÀ DI INSERIRE IN**

MEMORIA FINO A 100 PROGRAMMI. SENSORE PRESENZA E LIVELLO MASSIMO OLIO. POMPA FILTRAGGIO OLIO A CALDO MAX 180°C, PULIZIA VASCA, SVUOTAMENTO VASCA. 2 SOLLEVATORI CESTI INTEGRATI. VASCA 18 LITRI CM.31X34X33H - 2 CESTI CM.13,5X29X21H - FILTRO E COPERCHIO VASCA. BACINELLA RACCOLTA OLIO CON SUPPORTO SU RUOTE E FILTRO 5 MICRON (PZ.100 INCLUSI). PRODUZIONE PATATE: 27 KG/H (INCLUSA 1 TESTATA CHIUSURA PIANO MOD.TPA-9)

EN Electric electronic Fryer with a 7" TouchScreen. Conservation at 110 °C and preworking at 160 °C with or without Melting. Possibility to store in the memory up to 100 programs. Oil presence sensor and maximum level sensor. Pump for filter the hot oil max 180°C, Tank cleaning, Tank emptying. 2 Lifter for baskets integrated. Bowl 18 lts cm.31x34x33h - 2 baskets cm.13,5x29x21h. Sieve and lid for pan. Oil collection basin with support on wheels with sieve 5 microns (pcs.100 included). Production: 27 kg/h (included 1 Head end filler strip mod.TPA-9) • **DE** ELEKTRONISCHE ELEKTRISCHE FRITEUSE mit TouchScreen 7". Aufbewahrung bei 110 °C oder Vorbearbeitung bei 160 °C mit oder ohne Melting. Es können bis zu 100 Programme gespeichert werden. Anwesenheits- sowie maximaler Ölstandsensoren. Heißölfilterpumpe max 180°C, Tankreinigung, Tankentleerung. Integrierte 2 Korbheber. Becken 18 lt. cm.31x34x33h - 2 Körbe cm.13,5x29x21h. Einlegesieb und Deckel für Becken. Ölauffangbecken mit Halterung auf Rädern und 5-Mikron-Filter (Stk.100 inbegriffen). Pommes frites: 27 kg/h (inbegriffen 1 Abschluss-Element mod.TPA-9) • **FR** FRITEUSE ÉLECTRIQUE ÉLECTRONIQUE à Écran tactile 7". Conservation à 110 °C ou Pré-traitement à 160 °C avec ou sans Melting. Possibilité d'enregistrer jusqu'à 100 programmes en mémoire. Capteur de présence et de niveau maximal huile. Pompe filtration huile à chaud max 180°C, nettoyage cuve, vidange cuve. 2 Élévateurs paniers intégrés. Cuve 18 lt. cm.31x34x33h - 2 Paniers cm.13,5x29x21h. Filtre, couvercle pour cuve. Bassine de collecte de l'huile avec support sur roues et filtre 5 microns (pcs.100 inclus). Production de pommes frites: 27 kg/h (inclus 1 Élément de jonction top mod.TPA-9) • **ES** FREIDORA ELÉCTRICA ELECTRÓNICA con pantalla táctil de 7". Conservación a 110 °C o trabajo previo a 160 °C con o sin fusión. Se pueden almacenar hasta 100 programas en la memoria. Sensor de presencia y nivel máximo de aceite. Bomba de filtrado de aceite caliente, máximo 180 °C, limpieza del tanque, vaciado del tanque. 2 Elevadores de cesta integrados. Cuba de 18 litros cm. 31x34x33h - 2 cestas cm.13,5x29x21h. Filtro y tapa para cuba. Cubeta de recogida de aceite con soporte sobre ruedas y filtro de 5 micrones (pz.100 incluida). Prod. patatas: 27 Kg/h (incluida 1 Chapa de cierre para top mod.TPA-9)

cm. 40x 90x 90h



⚡ 16,55 kW **12.115,00**
400V~3N 89 / 0,54
50/60 Hz

MOD. _____
COD. _____

DESCRIZIONE/DESCRIPTION/BEZEICHNUNG/DESCRIPTION/DESCRIPCIÓN
DIMENSIONI/DIMENSIONS/ABMESSUNGEN/DIMENSIONS/DIMENSIONES

POTENZA/POWER/LEISTUNG/PUISSANCE/POTENCIA
VOLTAGGIO/VOLTAGE/SPANNUNG/VOLTAGE/VOLTAJE

⚡ kW kcal/h
⚡ kW
V~
Hz

PREZZO/PRICE
PREIS/PRIX/PRECIO
KG / M³



F2/18-98ETD FRIGGITRICE ELETTRICA ELETTRONICA CON TOUCHSCREEN 7". CONSERVAZIONE A 110 °C O PRELAVORO A 160 °C CON O SENZA MELTING. POSSIBILITÀ DI INSERIRE IN MEMORIA FINO A 100 PROGRAMMI. SENSORE PRESENZA E LIVELLO MASSIMO OLIO. 2 VASCHE 18 LITRI CM.31X34X33H - 4 CESTI CM.13,5X29X21H - FILTRI E COPERCHI VASCHE. 2 BACINELLE RACCOLTA OLIO CON SUPPORTO SU RUOTE. PRODUZIONE PATATE: 54 KG/H (INCLUSA 1 TESTATA CHIUSURA PIANO MOD.TPA-9)

0915A830



⚡ 31,9 kW **11.471,00**
400V~3N 118 / 1,05
50/60 Hz

EN Electric electronic Fryer with a 7" TouchScreen. Conservation at 110 °C and preworking at 160 °C with or without Melting. Possibility to store in the memory up to 100 programs. Oil presence sensor and maximum level sensor. 2 bowls 18 lts cm.31x34x33h - 4 baskets cm.13,5x29x21h. 2 Sieve and lid for pan. 2 Oil collection basin with support on wheels. Production: 54 kg/h (included 1 Head end filler strip mod.TPA-9) • **DE** ELEKTRONISCHE ELEKTRISCHE FRITEUSE mit TouchScreen 7". Aufbewahrung bei 110 °C oder Vorbearbeitung bei 160 °C mit oder ohne Melting. Es können bis zu 100 Programme gespeichert werden. Anwesenheits- sowie maximaler Ölstandsensor. 2 Becken 18 lt. cm.31x34x33h - 4 Körbe cm.13,5x29x21h. 2 Einlegesieb und Deckel für Becken. Ölauffangbecken mit Halterung auf Rädern. Pommes frites: 54 kg/h (inbegriffen 1 Abschluss-Element mod.TPA-9) • **FR** FRITEUSE ÉLECTRIQUE ÉLECTRONIQUE à Écran tactile 7". Conservation à 110 °C ou Pré-traitement à 160 °C avec ou sans Melting. Possibilité d'enregistrer jusqu'à 100 programmes en mémoire. Capteur de présence et de niveau maximal huile. 2 Cuves 18 lt. cm.31x34x33h - 4 Paniers cm.13,5x29x21h. 2 Filtre, couvercle pour cuve. 2 Bassine de collecte de l'huile avec support sur roues. Production de pommes frites: 54 kg/h (inclus 1 Élément de jonction top mod.TPA-9) • **ES** FREIDORA ELÉCTRICA ELECTRÓNICA con pantalla táctil de 7". Conservación a 110 °C o trabajo previo a 160 °C con o sin fusión. Se pueden almacenar hasta 100 programas en la memoria. Sensor de presencia y nivel máximo de aceite. 2 Cubas de 18 litros cm. 31x34x33h - 4 cestas cm.13,5x29x21h. 2 Filtros y tapas para cuba. 2 Cubetas de recogida de aceite con soporte sobre ruedas. Prod. patatas: 54 Kg/h (incluida 1 Chapa de cierre para top mod.TPA-9)

cm. 80x 90x 90h

FRIGGITRICI ELETTRICHE DIGITALI

MOD. _____
COD. _____

DESCRIZIONE/DESCRIPTION/BEZEICHNUNG/DESCRIPTION/DESCRIPCIÓN
DIMENSIONI/DIMENSIONS/ABMESSUNGEN/DIMENSIONS/DIMENSIONES

POTENZA/POWER/LEISTUNG/PUISSANCE/POTENCIA
VOLTAGGIO/VOLTAGE/SPANNUNG/VOLTAGE/VOLTAJE

⚡ kcal/h
⚡ kW
V~
Hz

PREZZO/PRICE
PREIS/PRIX/PRECIO
KG / M³



F2/18-98ETDP FRIGGITRICE ELETTRICA ELETTRONICA CON TOUCHSCREEN 7". CONSERVAZIONE A 110 °C O PRELAVORO A 160 °C CON O SENZA MELTING. POSSIBILITÀ DI INSERIRE IN MEMORIA FINO A 100 PROGRAMMI. SENSORE PRESENZA E LIVELLO MASSIMO OLIO. 2 POMPE FILTRAGGIO OLIO A CALDO MAX 180°C, PULIZIA VASCA, SVUOTAMENTO VASCA. 2 VASCHE 18 LITRI CM.31X34X33H - 4 CESTI CM.13,5X29X21H - FILTRI E COPERCHI VASCHE. 2 BACINELLE RACCOLTA OLIO CON SUPPORTO SU RUOTE E FILTRO 5 MICRON (PZ.100 INCLUSI). PRODUZIONE PATATE: 54 KG/H (INCLUSA 1 TESTATA CHIUSURA PIANO MOD.TPA-9)

EN Electric electronic Fryer with a 7" TouchScreen. Conservation at 110 °C and preworking at 160 °C with or without Melting. Possibility to store in the memory up to 100 programs. Oil presence sensor and maximum level sensor. 2 Pump for filter the hot oil max 180°C, Tank cleaning, Tank emptying. 2 bowls 18 lts cm.31x34x33h - 4 baskets cm.13,5x29x21h. 2 Sieve and lid for pan. 2 Oil collection basin with support on wheels with sieve 5 microns (pcs.100 included). Production: 54 kg/h (included 1 Head end filler strip mod.TPA-9) • **DE** ELEKTRONISCHE ELEKTRISCHE FRITEUSE mit TouchScreen 7". Aufbewahrung bei 110 °C oder Vorbearbeitung bei 160 °C mit oder ohne Melting. Es können bis zu 100 Programme gespeichert werden. Anwesenheits- sowie maximaler Ölstandsensoren. 2 Heißölfilterpumpe max 180°C, Tankreinigung, Tankentleerung. 2 Becken 18 lt. cm.31x34x33h - 4 Körbe cm.13,5x29x21h. 2 Einlegesieb und Deckel für Becken. 2 Ölauffangbecken mit Halterung auf Rädern und 5-Mikron-Filter (Stk.100 inbegriffen). Pommes frites: 54 kg/h (inbegriffen 1 Abschluss-Element mod.TPA-9) • **FR** FRITEUSE ÉLECTRIQUE ÉLECTRONIQUE à Écran tactile 7". Conservation à 110 °C ou Pré-traitement à 160 °C avec ou sans Melting. Possibilité d'enregistrer jusqu'à 100 programmes en mémoire. Capteur de présence et de niveau maximal huile. 2 Pompe filtration huile à chaud max 180°C, nettoyage cuve, vidange cuve. 2 Cuves 18 lt. cm.31x34x33h - 4 Paniers cm.13,5x29x21h. 2 Filtre, couvercle pour cuve. 2 Bassine de collecte de l'huile avec support sur roues et filtre 5 microns (pcs.100 inclus). Production de pommes frites: 54 kg/h (inclus 1 Élément de jonction top mod.TPA-9) • **ES** FREIDORA ELÉCTRICA ELECTRÓNICA con pantalla táctil de 7". Conservación a 110 °C o trabajo previo a 160 °C con o sin fusión. Se pueden almacenar hasta 100 programas en la memoria. Sensor de presencia y nivel máximo de aceite. 2 Bomba de filtrado de aceite caliente, máximo 180 °C, limpieza del tanque, vaciado del tanque. 2 Cubas de 18 litros cm. 31x34x33h - 4 cestas cm.13,5x29x21h. 2 Filtros y tapas para cuba. 2 Cubetas de recogida de aceite con soporte sobre ruedas y filtro de 5 micrones (pz.100 incluida). Prod. patatas: 54 Kg/h (incluida 1 Chapa de cierre para top mod.TPA-9)
cm. 80x 90x 90h



⚡ 32,4 kW **18.239,00**
400V~3N 138 / 1,05
50/60 Hz

FRIGGITRICI ELETTRICHE DIGITALI

MOD. _____
COD. _____

DESCRIZIONE/DESCRIPTION/BEZEICHNUNG/DESCRIPTION/DESCRIPCIÓN
DIMENSIONI/DIMENSIONS/ABMESSUNGEN/DIMENSIONS/DIMENSIONES

POTENZA/POWER/LEISTUNG/PUISSANCE/POTENCIA
VOLTAGGIO/VOLTAGE/SPANNUNG/VOLTAGE/VOLTAJE

⚡ kcal/h ⚡ kW
V~
Hz

PREZZO/PRICE
PREIS/PRIX/PRECIO
KG / M³



F2/18-98ETDPS FRIGGITRICE ELETTRICA ELETTRONICA CON TOUCHSCREEN
0915A832 **7". CONSERVAZIONE A 110 °C O PRELAVORO A 160 °C CON O SENZA MELTING. POSSIBILITÀ DI INSERIRE IN**

MEMORIA FINO A 100 PROGRAMMI. SENSORE PRESENZA E LIVELLO MASSIMO OLIO. 2 POMPE FILTRAGGIO OLIO A CALDO MAX 180°C, PULIZIA VASCA, SVUOTAMENTO VASCA. 4 SOLLEVATORI CESTI INTEGRATI. 2 VASCHE 18 LITRI CM.31X34X33H - 4 CESTI CM.13,5X29X21H - FILTRI E COPERCHI VASCHE. 2 BACINELLE RACCOLTA OLIO CON SUPPORTO SU RUOTE E FILTRO 5 MICRON (PZ.100 INCLUSI). PRODUZIONE PATATE: 54 KG/H (INCLUSA 1 TESTATA CHIUSURA PIANO MOD.TPA-9)

EN Electric electronic Fryer with a 7" TouchScreen. Conservation at 110 °C and preworking at 160 °C with or without Melting. Possibility to store in the memory up to 100 programs. Oil presence sensor and maximum level sensor. 2 Pump for filter the hot oil max 180°C, Tank cleaning, Tank emptying. 4 Lifter for baskets integrated. 2 bowls 18 lts cm.31x34x33h - 4 baskets cm.13,5x29x21h. 2 Sieve and lid for pan. 2 Oil collection basin with support on wheels with sieve 5 microns (pcs.100 included). Production: 54 kg/h (included 1 Head end filler strip mod. TPA-9) • **DE** ELEKTRONISCHE ELEKTRISCHE FRITEUSE mit TouchScreen 7". Aufbewahrung bei 110 °C oder Vorbearbeitung bei 160 °C mit oder ohne Melting. Es können bis zu 100 Programme gespeichert werden. Anwesenheits- sowie maximaler Ölstandsensoren. 2 Heißölfilterpumpe max 180°C, Tankreinigung, Tankentleerung. Integrierte 4 Korbheber. 2 Becken 18 lt. cm.31x34x33h - 4 Körbe cm.13,5x29x21h. 2 Einlegesieb und Deckel für Becken. 2 Ölauffangbecken mit Halterung auf Rädern und 5-Mikron-Filter (Stk.100 inbegriffen). Pommes frites: 54 kg/h (inbegriffen 1 Abschluss-Element mod.TPA-9) • **FR** FRITEUSE ÉLECTRIQUE ÉLECTRONIQUE à Écran tactile 7". Conservation à 110 °C ou Pré-traitement à 160 °C avec ou sans Melting. Possibilité d'enregistrer jusqu'à 100 programmes en mémoire. Capteur de présence et de niveau maximal huile. 2 Pompe filtration huile à chaud max 180°C, nettoyage cuve, vidange cuve. 4 Élévateurs paniers intégrés. 2 Cuve 18 lt. cm.31x34x33h - 4 Paniers cm.13,5x29x21h. 2 Filtre, couvercle pour cuve. 2 Bassine de collecte de l'huile avec support sur roues et filtre 5 microns (pcs.100 inclus). Production de pommes frites: 54 kg/h (inclus 1 Élément de jonction top mod.TPA-9) • **ES** FREIDORA ELÉCTRICA ELECTRÓNICA con pantalla táctil de 7". Conservación a 110 °C o trabajo previo a 160 °C con o sin fusión. Se pueden almacenar hasta 100 programas en la memoria. Sensor de presencia y nivel máximo de aceite. 2 Bomba de filtrado de aceite caliente, máximo 180 °C, limpieza del tanque, vaciado del tanque. 4 Elevadores de cesta integrados. 2 Cubas de 18 litros cm. 31x34x33h - 4 cestas cm.13,5x29x21h. 2 Filtros y tapas para cuba. 2 Cubetas de recogida de aceite con soporte sobre ruedas y filtro de 5 micrones (p.z.100 incluida). Prod. patatas: 54 Kg/h (incluida 1 Chapa de cierre para top mod.TPA-9)

cm. 80x 90x 90h



⚡ 33,1 kW **22.976,00**
400V~3N 158 / 1,05
50/60 Hz

FRIGGITRICI ELETTRICHE DIGITALI

MOD. _____
COD. _____

DESCRIZIONE/DESCRIPTION/BEZEICHNUNG/DESCRIPTION/DESCRIPCIÓN
DIMENSIONI/DIMENSIONS/ABMESSUNGEN/DIMENSIONS/DIMENSIONES

POTENZA/POWER/LEISTUNG/PUISSANCE/POTENCIA
VOLTAGGIO/VOLTAGE/SPANNUNG/VOLTAGE/VOLTAJE

$\frac{kW}{kcal/h}$ $\frac{kw}{V\sim}$
Hz

PREZZO/PRICE
PREIS/PRIX/PRECIO
KG / M³



F25-94ETD
0915B430

FRIGGITRICE ELETTRICA ELETTRONICA CON TOUCHSCREEN 7". CONSERVAZIONE A 110 °C O PRELAVORO A 160 °C CON O SENZA MELTING. POSSIBILITÀ DI INSERIRE IN MEMORIA FINO A 100 PROGRAMMI. SENSORE PRESENZA E LIVELLO MASSIMO OLIO. VASCA 25 LITRI CM.31X51X33H - 2 CESTI CM.13,5X45X21H - FILTRO E COPERCHIO VASCA. BACINELLA RACCOLTA OLIO CON SUPPORTO SU RUOTE. PRODUZIONE PATATE: 35 KG/H (INCLUSA 1 TESTATA CHIUSURA PIANO MOD.TPA-9)

EN Electric electronic Fryer with a 7" TouchScreen. Conservation at 110 °C and preworking at 160 °C with or without Melting. Possibility to store in the memory up to 100 programs. Oil presence sensor and maximum level sensor. Bowl 25 lts cm.31x51x33h - 2 baskets cm.13,5x45x21h. Sieve and lid for pan. Oil collection basin with support on wheels. Production: 35 Kg/h (included 1 Head end filler strip mod. TPA-9) • **DE** ELEKTRONISCHE ELEKTRISCHE FRITEUSE mit TouchScreen 7". Aufbewahrung bei 110 °C oder Vorbereitung bei 160 °C mit oder ohne Melting. Es können bis zu 100 Programme gespeichert werden. Anwesenheits- sowie maximaler Ölstandsensor. Becken 25 lt. cm.31x51x33h - 2 Körbe cm.13,5x45x21h. Einlegesieb und Deckel für Becken. Ölauffangbecken mit Halterung auf Rädern. Pommes frites: 35 kg/h (inbegriffen 1 Abschluss-Element mod.TPA-9) • **FR** FRITEUSE ÉLECTRIQUE ÉLECTRONIQUE à Écran tactile 7". Conservation à 110 °C ou Pré-traitement à 160 °C avec ou sans Melting. Possibilité d'enregistrer jusqu'à 100 programmes en mémoire. Capteur de présence et de niveau maximal huile. Cuve 25 lt. cm.31x51x33h - 2 Paniers cm.13,5x45x21h. Filtre, couvercle pour cuve. Bassine de collecte de l'huile avec support sur roues. Production de pommes frites: 35 kg/h (inclus 1 Élément de jonction top mod.TPA-9) • **ES** FREIDORA ELÉCTRICA ELECTRÓNICA con pantalla táctil de 7". Conservación a 110 °C o trabajo previo a 160 °C con o sin fusión. Se pueden almacenar hasta 100 programas en la memoria. Sensor de presencia y nivel máximo de aceite. Cuba de 25 litros cm. 31x51x33h - 2 cestas cm.13,5x45x21h. Filtro y tapa para cuba. Cubeta de recogida de aceite con soporte sobre ruedas. Prod. patatas: 35 kg/h (incluida 1 Chapa de cierre para top mod.TPA-9)
cm. 40x 90x 90h



$\frac{22,05 kW}{400V\sim 3N}$ **6.613,00**
 $\frac{72}{50/60 Hz}$ / 0,54

MOD. _____
COD. _____

DESCRIZIONE/DESCRIPTION/BEZEICHNUNG/DESCRIPTION/DESCRIPCIÓN
DIMENSIONI/DIMENSIONS/ABMESSUNGEN/DIMENSIONS/DIMENSIONES

POTENZA/POWER/LEISTUNG/PUISSANCE/POTENCIA
VOLTAGGIO/VOLTAGE/SPANNUNG/VOLTAGE/VOLTAJE

⚡ kcal/h
⚡ kW
V~
Hz

PREZZO/PRICE
PREIS/PRIX/PRECIO
KG / M³



F25-94ETDP FRIGGITRICE ELETTRICA ELETTRONICA CON TOUCHSCREEN
0915B431 **7". CONSERVAZIONE A 110 °C O PRELAVORO A 160 °C CON O SENZA MELTING. POSSIBILITÀ DI INSERIRE IN MEMORIA FINO A 100 PROGRAMMI. SENSORE PRESENZA E LIVELLO MASSIMO OLIO. POMPA FILTRAGGIO OLIO A CALDO MAX 180°C, PULIZIA VASCA, SVUOTAMENTO VASCA. VASCA 25 LITRI CM.31X51X33H - 2 CESTI CM.13,5X45X21H - FILTRO E COPERCHIO VASCA. BACINELLA RACCOLTA OLIO CON SUPPORTO SU RUOTE E FILTRO 5 MICRON (PZ.100 INCLUSI). PRODUZIONE PATATE: 35 KG/H (INCLUSA 1 TESTATA CHIUSURA PIANO MOD.TPA-9)**

EN Electric electronic Fryer with a 7" TouchScreen. Conservation at 110 °C and preworking at 160 °C with or without Melting. Possibility to store in the memory up to 100 programs. Oil presence sensor and maximum level sensor. Pump for filter the hot oil max 180°C, Tank cleaning, Tank emptying. Bowl 25 lts cm.31x51x33h - 2 baskets cm.13,5x45x21h. Sieve and lid for pan. Oil collection basin with support on wheels with sieve 5 microns (pcs.100 included). Production: 35 Kg/h (included 1 Head end filler strip mod.TPA-9) • **DE** ELEKTRONISCHE ELEKTRISCHE FRITEUSE mit TouchScreen 7". Aufbewahrung bei 110 °C oder Vorbearbeitung bei 160 °C mit oder ohne Melting. Es können bis zu 100 Programme gespeichert werden. Anwesenheits- sowie maximaler Ölstandsensoren. Heißölfilterpumpe max 180°C, Tankreinigung, Tankentleerung. Becken 25 lt. cm.31x51x33h - 2 Körbe cm.13,5x45x21h. Einlegesieb und Deckel für Becken. Ölauffangbecken mit Halterung auf Rädern und 5-Mikron-Filter (Stk.100 inbegriffen). Pommes frites: 35 kg/h (inbegriffen 1 Abschluss-Element mod.TPA-9) • **FR** FRITEUSE ÉLECTRIQUE ÉLECTRONIQUE à Écran tactile 7". Conservation à 110 °C ou Pré-traitement à 160 °C avec ou sans Melting. Possibilité d'enregistrer jusqu'à 100 programmes en mémoire. Capteur de présence et de niveau maximal huile. Pompe filtration huile à chaud max 180°C, nettoyage cuve, vidange cuve. Cuve 25 lt. cm.31x51x33h - 2 Paniers cm.13,5x45x21h. Filtre, couvercle pour cuve. Bassine de collecte de l'huile avec support sur roues et filtre 5 microns (pcs.100 inclus). Production de pommes frites: 35 kg/h (inclus 1 Élément de jonction top mod.TPA-9) • **ES** FREIDORA ELÉCTRICA ELECTRÓNICA con pantalla táctil de 7". Conservación a 110 °C o trabajo previo a 160 °C con o sin fusión. Se pueden almacenar hasta 100 programas en la memoria. Sensor de presencia y nivel máximo de aceite. Bomba de filtrado de aceite caliente, máximo 180 °C, limpieza del tanque, vaciado del tanque. Cuba de 25 litros cm. 31x51x33h - 2 cestas cm.13,5x45x21h. Filtro y tapa para cuba. Cubeta de recogida de aceite con soporte sobre ruedas y filtro de 5 micrones (pz.100 incluida). Prod. patatas: 35 kg/h (incluida 1 Chapa de cierre para top mod.TPA-9)

cm. 40x 90x 90h



⚡ 22,3 kW
400V~3N
50/60 Hz **9.996,00**
82 / 0,54

FRIGGITRICI ELETTRICHE DIGITALI

MOD. _____
COD. _____

DESCRIZIONE/DESCRIPTION/BEZEICHNUNG/DESCRIPTION/DESCRIPCIÓN
DIMENSIONI/DIMENSIONS/ABMESSUNGEN/DIMENSIONS/DIMENSIONES

POTENZA/POWER/LEISTUNG/PUISSANCE/POTENCIA
VOLTAGGIO/VOLTAGE/SPANNUNG/VOLTAGE/VOLTAJE

⚡ kW
kcal/h

⚡ kw
V~
Hz

PREZZO/PRICE
PREIS/PRIX/PRECIO
KG / M³



F25-94ETDPS FRIGGITRICE ELETTRICA ELETTRONICA CON TOUCHSCREEN
0915B432

7". CONSERVAZIONE A 110 °C O PRELAVORO A 160 °C CON O SENZA MELTING. POSSIBILITÀ DI INSERIRE IN MEMORIA FINO A 100 PROGRAMMI. SENSORE PRESENZA E LIVELLO MASSIMO OLIO. POMPA FILTRAGGIO OLIO A CALDO MAX 180°C, PULIZIA VASCA, SVUOTAMENTO VASCA. SOLLEVATORI CESTI INTEGRATI. VASCA 25 LITRI CM.31X51X33H - 2 CESTI CM.13,5X45X21H - FILTRO E COPERCHIO VASCA. BACINELLA RACCOLTA OLIO CON SUPPORTO SU RUOTE E FILTRO 5 MICRON (PZ.100 INCLUSI). PRODUZIONE PATATE: 35 KG/H (INCLUSA 1 TESTATA CHIUSURA PIANO MOD.TPA-9)

EN Electric electronic Fryer with a 7" TouchScreen. Conservation at 110 °C and preworking at 160 °C with or without Melting. Possibility to store in the memory up to 100 programs. Oil presence sensor and maximum level sensor. Pump for filter the hot oil max 180°C, Tank cleaning, Tank emptying. 2 Lifter for baskets integrated. Bowl 25 lts cm.31x51x33h - 2 baskets cm.13,5x45x21h. Sieve and lid for pan. Oil collection basin with support on wheels with sieve 5 microns (pcs.100 included). Production: 35 Kg/h (included 1 Head end filler strip mod.TPA-9) • **DE** ELEKTRONISCHE ELEKTRISCHE FRITEUSE mit TouchScreen 7". Aufbewahrung bei 110 °C oder Vorbereitung bei 160 °C mit oder ohne Melting. Es können bis zu 100 Programme gespeichert werden. Anwesenheits- sowie maximaler Ölstandsensoren. Heißölfilterpumpe max 180°C, Tankreinigung, Tankentleerung. Integrierte 2 Korbheber. Becken 25 lt. cm.31x51x33h - 2 Körbe cm.13,5x45x21h. Einlegesieb und Deckel für Becken. Ölauffangbecken mit Halterung auf Rädern und 5-Mikron-Filter (Stk.100 inbegriffen). Pommes frites: 35 kg/h (inbegriffen 1 Abschluss-Element mod.TPA-9) • **FR** FRITEUSE ÉLECTRIQUE ÉLECTRONIQUE à Écran tactile 7". Conservation à 110 °C ou Pré-traitement à 160 °C avec ou sans Melting. Possibilité d'enregistrer jusqu'à 100 programmes en mémoire. Capteur de présence et de niveau maximal huile. Pompe filtration huile à chaud max 180°C, nettoyage cuve, vidange cuve. 2 Élévateurs paniers intégrés. Cuve 25 lt. cm.31x51x33h - 2 Paniers cm.13,5x45x21h. Filtre, couvercle pour cuve. Bassine de collecte de l'huile avec support sur roues et filtre 5 microns (pcs.100 inclus). Production de pommes frites: 35 kg/h (inclus 1 Élément de jonction top mod.TPA-9) • **ES** FREIDORA ELÉCTRICA ELECTRÓNICA con pantalla táctil de 7". Conservación a 110 °C o trabajo previo a 160 °C con o sin fusión. Se pueden almacenar hasta 100 programas en la memoria. Sensor de presencia y nivel máximo de aceite. Bomba de filtrado de aceite caliente, máximo 180 °C, limpieza del tanque, vaciado del tanque. 2 Elevadores de cesta integrados. Cuba de 25 litros cm. 31x51x33h - 2 cestas cm.13,5x45x21h. Filtro y tapa para cuba. Cubeta de recogida de aceite con soporte sobre ruedas y filtro de 5 micrones (pz.100 incluida). Prod. patatas: 35 kg/h (incluida 1 Chapa de cierre para top mod.TPA-9)

cm. 40x 90x 90h



⚡ 22,65 kW **12.365,00**
400V~3N 92 / 0,54
50/60 Hz

FRIGGITRICI ELETTRICHE DIGITALI

MOD. _____
COD. _____

DESCRIZIONE/DESCRIPTION/BEZEICHNUNG/DESCRIPTION/DESCRIPCIÓN
DIMENSIONI/DIMENSIONS/ABMESSUNGEN/DIMENSIONS/DIMENSIONES

POTENZA/POWER/LEISTUNG/PUISSANCE/POTENCIA
VOLTAGGIO/VOLTAGE/SPANNUNG/VOLTAGE/VOLTAJE

⚡ kW kcal/h
⚡ kW V~ Hz

PREZZO/PRICE
PREIS/PRIX/PRECIO
KG / M³



F2/25-98ETD FRIGGITRICE ELETTRICA ELETTRONICA CON TOUCHSCREEN 7". CONSERVAZIONE A 110 °C O PRELAVORO A 160 °C CON O SENZA MELTING. POSSIBILITÀ DI INSERIRE IN MEMORIA FINO A 100 PROGRAMMI. SENSORE PRESENZA E LIVELLO MASSIMO OLIO. 2 VASCHE 25 LITRI CM.31X51X33H - 4 CESTI CM.13,5X45X21H - FILTRI E COPERCHI VASCHE. 2 BACINELLE RACCOLTA OLIO CON SUPPORTO SU RUOTE. PRODUZIONE PATATE: 70 KG/H (INCLUSA 1 TESTATA CHIUSURA PIANO MOD.TPA-9)

0915B830



⚡ 44,1 kW **11.973,00**
400V~3N 126 / 1,05
50/60 Hz

EN Electric electronic Fryer with a 7" TouchScreen. Conservation at 110 °C and preworking at 160 °C with or without Melting. Possibility to store in the memory up to 100 programs. Oil presence sensor and maximum level sensor. 2 bowl 25 lts cm.31x51x33h - 4 baskets cm.13,5x45x21h. 2 Sieve and lid for pan. 2 Oil collection basin with support on wheels. Production: 70 kg/h (included 1 Head end filler strip mod.TPA-9) • **DE** ELEKTRONISCHE ELEKTRISCHE FRITEUSE mit TouchScreen 7". Aufbewahrung bei 110 °C oder Vorbearbeitung bei 160 °C mit oder ohne Melting. Es können bis zu 100 Programme gespeichert werden. Anwesenheits- sowie maximaler Ölstandsensor. 2 Becken 25 lt. cm.31x51x33h - 4 Körbe cm.13,5x45x21h. 2 Einlegesieb und Deckel für Becken. Ölauffangbecken mit Halterung auf Rädern. Pommes frites: 70 kg/h (inbegriffen 1 Abschluss-Element mod.TPA-9) • **FR** FRITEUSE ÉLECTRIQUE ÉLECTRONIQUE à Écran tactile 7". Conservation à 110 °C ou Pré-traitement à 160 °C avec ou sans Melting. Possibilité d'enregistrer jusqu'à 100 programmes en mémoire. Capteur de présence et de niveau maximal huile. 2 Cuves 25 lt. cm.31x51x33h - 4 Paniers cm.13,5x45x21h. 2 Filtre, couvercle pour cuve. 2 Bassine de collecte de l'huile avec support sur roues. Production de pommes frites: 70 kg/h (inclus 1 Élément de jonction top mod.TPA-9) • **ES** FREIDORA ELÉCTRICA ELECTRÓNICA con pantalla táctil de 7". Conservación a 110 °C o trabajo previo a 160 °C con o sin fusión. Se pueden almacenar hasta 100 programas en la memoria. Sensor de presencia y nivel máximo de aceite. 2 Cubas de 25 litros cm. 31x51x33h - 4 cestas cm.13,5x45x21h. 2 Filtros y tapas para cuba. 2 Cubetas de recogida de aceite con soporte sobre ruedas. Prod. patatas: 70 kg/h (incluida 1 Chapa de cierre para top mod. TPA-9)

cm. 80x 90x 90h

FRIGGITRICI ELETTRICHE DIGITALI

MOD. _____
COD. _____

DESCRIZIONE/DESCRIPTION/BEZEICHNUNG/DESCRIPTION/DESCRIPCIÓN
DIMENSIONI/DIMENSIONS/ABMESSUNGEN/DIMENSIONS/DIMENSIONES

POTENZA/POWER/LEISTUNG/PUISSANCE/POTENCIA
VOLTAGGIO/VOLTAGE/SPANNUNG/VOLTAGE/VOLTAJE

$\frac{kW}{kcal/h}$ $\frac{kw}{V}$
Hz

PREZZO/PRICE
PREIS/PRIX/PRECIO
KG / M³



F2/25-98ETDP FRIGGITRICE ELETTRICA ELETTRONICA CON TOUCHSCREEN 7". CONSERVAZIONE A 110 °C O PRELAVORO A 160 °C CON O SENZA MELTING. POSSIBILITÀ DI INSERIRE IN MEMORIA FINO A 100 PROGRAMMI. SENSORE PRESENZA E LIVELLO MASSIMO OLIO. 2 POMPE FILTRAGGIO OLIO A CALDO MAX 180°C, PULIZIA VASCA, SVUOTAMENTO VASCA. 2 VASCHE 25 LITRI CM.31X51X33H - 4 CESTI CM.13,5X45X21H - FILTRI E COPERCHI VASCHE. 2 BACINELLE RACCOLTA OLIO CON SUPPORTO SU RUOTE E FILTRO 5 MICRON (PZ.100 INCLUSI). PRODUZIONE PATATE: 70 KG/H (INCLUSA 1 TESTATA CHIUSURA PIANO MOD.TPA-9)

EN Electric electronic Fryer with a 7" TouchScreen. Conservation at 110 °C and preworking at 160 °C with or without Melting. Possibility to store in the memory up to 100 programs. Oil presence sensor and maximum level sensor. 2 pump for filter the hot oil max 180°C, Tank cleaning, Tank emptying. 2 bowl 25 lts cm.31x51x33h - 4 baskets cm.13,5x45x21h. 2 Sieve and lid for pan. 2 Oil collection basin with support on wheels with sieve 5 microns (pcs.100 included). Production: 70 kg/h (included 1 Head end filler strip mod.TPA-9) • **DE** ELEKTRONISCHE ELEKTRISCHE FRITEUSE mit TouchScreen 7". Aufbewahrung bei 110 °C oder Vorbearbeitung bei 160 °C mit oder ohne Melting. Es können bis zu 100 Programme gespeichert werden. Anwesenheits- sowie maximaler Ölstandsensoren. 2 Heißölfilterpumpe max 180°C, Tankreinigung, Tankentleerung. 2 Becken 25 lt. cm.31x51x33h - 4 Körbe cm.13,5x45x21h. 2 Einlegesieb und Deckel für Becken. 2 Ölauffangbecken mit Halterung auf Rädern und 5-Mikron-Filter (Stk.100 inbegriffen). Pommes frites: 70 kg/h (inbegriffen 1 Abschluss-Element mod.TPA-9) • **FR** FRITEUSE ÉLECTRIQUE ÉLECTRONIQUE à Écran tactile 7". Conservation à 110 °C ou Pré-traitement à 160 °C avec ou sans Melting. Possibilité d'enregistrer jusqu'à 100 programmes en mémoire. Capteur de présence et de niveau maximal huile. 2 Pompe filtration huile à chaud max 180°C, nettoyage cuve, vidange cuve. 2 Cuves 25 lt. cm.31x51x33h - 4 Paniers cm.13,5x45x21h. 2 Filtre, couvercle pour cuve. 2 Bassine de collecte de l'huile avec support sur roues et filtre 5 microns (pcs.100 inclus). Production de pommes frites: 70 kg/h (inclus 1 Élément de jonction top mod.TPA-9) • **ES** FREIDORA ELÉCTRICA ELECTRÓNICA con pantalla táctil de 7". Conservación a 110 °C o trabajo previo a 160 °C con o sin fusión. Se pueden almacenar hasta 100 programas en la memoria. Sensor de presencia y nivel máximo de aceite. 2 Bomba de filtrado de aceite caliente, máximo 180 °C, limpieza del tanque, vaciado del tanque. 2 Cubas de 25 litros cm. 31x51x33h - 4 cestas cm.13,5x45x21h. 2 Filtros y tapas para cuba. 2 Cubetas de recogida de aceite con soporte sobre ruedas y filtro de 5 micrones (pz.100 incluida). Prod. patatas: 70 kg/h (incluida 1 Chapa de cierre para top mod.TPA-9)
cm. 80x 90x 90h



$\frac{kW}{kcal/h}$ $\frac{kw}{V}$
Hz

44,6 kW **18.740,00**
400V~3N 146 / 1,05
50/60 Hz

FRIGGITRICI ELETTRICHE DIGITALI

MOD. _____
COD. _____

DESCRIZIONE/DESCRIPTION/BEZEICHNUNG/DESCRIPTION/DESCRIPCIÓN
DIMENSIONI/DIMENSIONS/ABMESSUNGEN/DIMENSIONS/DIMENSIONES

POTENZA/POWER/LEISTUNG/PUISSANCE/POTENCIA
VOLTAGGIO/VOLTAGE/SPANNUNG/VOLTAGE/VOLTAJE

⚡ kW kcal/h
⚡ kW V~ Hz

PREZZO/PRICE
PREIS/PRIX/PRECIO
KG / M³



F2/25-98ETDPS FRIGGITRICE ELETTRICA ELETTRONICA CON TOUCHSCREEN 7". CONSERVAZIONE A 110 °C O PRELAVORO A 160 °C CON O SENZA MELTING. POSSIBILITÀ DI INSERIRE IN MEMORIA FINO A 100 PROGRAMMI. SENSORE PRESENZA E LIVELLO MASSIMO OLIO. 2 POMPE FILTRAGGIO OLIO A CALDO MAX 180°C, PULIZIA VASCA, SVUOTAMENTO VASCA. 4 SOLLEVATORI CESTI INTEGRATI. 2 VASCHE 25 LITRI CM.31X51X33H - 4 CESTI CM.13,5X45X21H - FILTRI E COPERCHI VASCHE. 2 BACINELLE RACCOLTA OLIO CON SUPPORTO SU RUOTE E FILTRO 5 MICRON (PZ.100 INCLUSI). PRODUZIONE PATATE: 70 KG/H (INCLUSA 1 TESTATA CHIUSURA PIANO MOD.TPA-9)

0915B832

EN Electric electronic Fryer with a 7" TouchScreen. Conservation at 110 °C and preworking at 160 °C with or without Melting. Possibility to store in the memory up to 100 programs. Oil presence sensor and maximum level sensor. 2 pump for filter the hot oil max 180°C, Tank cleaning, Tank emptying. 4 Lifter for baskets integrated. 2 bowl 25 lts cm.31x51x33h - 4 baskets cm.13,5x45x21h. 2 Sieve and lid for pan. 2 Oil collection basin with support on wheels with sieve 5 microns (pcs.100 included). Production: 70 kg/h (included 1 Head end filler strip mod. TPA-9) • **DE** ELEKTRONISCHE ELEKTRISCHE FRITEUSE mit TouchScreen 7". Aufbewahrung bei 110 °C oder Vorbearbeitung bei 160 °C mit oder ohne Melting. Es können bis zu 100 Programme gespeichert werden. Anwesenheits- sowie maximaler Ölstandsensoren. 2 Heißölfilterpumpe max 180°C, Tankreinigung, Tankentleerung. Integrierte 4 Korbheber. 2 Becken 25 lt. cm.31x51x33h - 4 Körbe cm.13,5x45x21h. 2 Einlegesieb und Deckel für Becken. 2 Ölauffangbecken mit Halterung auf Rädern und 5-Mikron-Filter (Stk.100 inbegriffen). Pommes frites: 70 kg/h (inbegriffen 1 Abschluss-Element mod.TPA-9) • **FR** FRITEUSE ÉLECTRIQUE ÉLECTRONIQUE à Écran tactile 7". Conservation à 110 °C ou Pré-traitement à 160 °C avec ou sans Melting. Possibilité d'enregistrer jusqu'à 100 programmes en mémoire. Capteur de présence et de niveau maximal huile. 2 Pompe filtration huile à chaud max 180°C, nettoyage cuve, vidange cuve. 4 Élévateurs paniers intégrés. 2 Cuve 25 lt. cm.31x51x33h - 4 Paniers cm.13,5x45x21h. 2 Filtre, couvercle pour cuve. 2 Bassine de collecte de l'huile avec support sur roues et filtre 5 microns (pcs.100 inclus). Production de pommes frites: 70 kg/h (inclus 1 Élément de jonction top mod.TPA-9) • **ES** FREIDORA ELÉCTRICA ELECTRÓNICA con pantalla táctil de 7". Conservación a 110 °C o trabajo previo a 160 °C con o sin fusión. Se pueden almacenar hasta 100 programas en la memoria. Sensor de presencia y nivel máximo de aceite. 2 Bomba de filtrado de aceite caliente, máximo 180 °C, limpieza del tanque, vaciado del tanque. 4 Elevadores de cesta integrados. 2 Cubas de 25 litros cm. 31x51x33h - 4 cestas cm.13,5x45x21h. 2 Filtros y tapas para cuba. 2 Cubetas de recogida de aceite con soporte sobre ruedas y filtro de 5 micrones (pz.100 incluida). Prod. patatas: 70 kg/h (incluida 1 Chapa de cierre para top mod.TPA-9)

cm. 80x 90x 90h



⚡ 45,3 kW **23.477,00**
400V~3N 166 / 1,05
50/60 Hz

BR80-98ETF/I BRASIERA A RIBALTAMENTO MANUALE, VASCA 80 LITRI CM.72X56X22,5H, FONDO INOX CON COPERCHIO

09070835

EN Braising pan with manual tilting, bowl 80 lt. cm.72x56x22,5h, Stainless steel bottom with lid • **DE** Kippbratpfanne mit manual Kippung, 80 Lt. cm.72x56x22,5h, boden aus crnst. mit deckel • **FR** Sauteuse avec basculement manuel, cuve 80 lt. cm.72x56x22,5h, fond inox avec couvercle • **ES** Sartén con levantamiento manual, cuba 80 lt. cm.72x56x22,5h, fondo de acero inox con tapa

cm. 80x 90x 90h



⚡ 12 kW **6.907,00**
400V~3N 156 / 0,89
50/60 Hz

BRM80-98ETF/I BRASIERA A RIBALTAMENTO AUTOMATICO, VASCA 80 LITRI CM.72X56X22,5H, FONDO INOX CON COPERCHIO

09070836

EN Braising pan with automatic tilting, bowl 80 lt. cm.72x56x22,5h, Stainless steel bottom with lid • **DE** Kippbratpfanne mit automatisch Kippung, 80 Lt. cm.72x56x22,5h, boden aus crnst. mit deckel • **FR** Sauteuse avec basculement automatique, cuve 80 lt. cm.72x56x22,5h, fond inox avec couvercle • **ES** Sartén con levantamiento automatico, cuba 80 lt. cm.72x56x22,5h, fondo de acero inox con tapa

cm. 80x 90x 90h



⚡ 12,1 kW **8.436,00**
400V~3N 162 / 0,89
50 Hz

BRASIERE RIBALTABILI A GAS

MOD. _____
COD. _____

DESCRIZIONE/DESCRIPTION/BEZEICHNUNG/DESCRIPTION/DESCRIPCIÓN
DIMENSIONI/DIMENSIONS/ABMESSUNGEN/DIMENSIONS/DIMENSIONES

POTENZA/POWER/LEISTUNG/PUISSANCE/POTENCIA
VOLTAGGIO/VOLTAGE/SPANNUNG/VOLTAGE/VOLTAJE

⚡ $\frac{\text{kW}}{\text{kcal/h}}$ $\frac{\text{kW}}{\text{V~}}$
Hz

PREZZO/PRICE
PREIS/PRIX/PRECIO
KG / M³



BR80-98GF/I BRASIERA A RIBALTAMENTO MANUALE, VASCA 80 LITRI
09240855 **CM.72X56X22,5H, FONDO INOX CON COPERCHIO**

EN Braising pan with manual tilting, bowl 80 lt. cm.72x56x22,5h, Stainless steel bottom with lid • **DE** Kippbratpfanne mit manual Kippung, 80 Lt. cm.72x56x22,5h, boden aus crnst. mit deckel • **FR** Sauteuse avec basculement manuel, cuve 80 lt. cm.72x56x22,5h, fond inox avec couvercle • **ES** Sartén con levantamiento manual, cuba 80 lt. cm.72x56x22,5h, fondo de acero inox con tapa
cm. 80x 90x 90h



⚡ $\frac{22 \text{ kW}}{18.920 \text{ kcal/h}}$ **6.857,00**
159 / 0,89

BRM80-98GF/I BRASIERA A RIBALTAMENTO AUTOMATICO, VASCA 80 LITRI
09240856 **CM.72X56X22,5H, FONDO INOX CON COPERCHIO**

EN Braising pan with automatic tilting, bowl 80 lt. cm.72x56x22,5h, Stainless steel bottom with lid • **DE** Kippbratpfanne mit automatisch Kippung, 80 Lt. cm.72x56x22,5h, boden aus crnst. mit deckel • **FR** Sauteuse avec basculement automatique, cuve 80 lt. cm.72x56x22,5h, fond inox avec couvercle • **ES** Sartén con levantamiento automatico, cuba 80 lt. cm.72x56x22,5h, fondo de acero inox con tapa
cm. 80x 90x 90h



⚡ $\frac{22 \text{ kW}}{18.920 \text{ kcal/h}}$ **8.602,00**
165 / 0,89

⚡ $\frac{0,1 \text{ kW}}{230 \text{ V~}}$
50 Hz

BRF-94ET BRASIERA FISSA MULTIFUNZIONALE ELETTRICA VASCA CM.
09070433 **30X68X10H (INCLUSA 1 TESTATA CHIUSURA PIANO MOD. TPA-9)**

EN Electric multi-function fixed braising pan Bowl cm. 30x68x10h (included 1 Head end filler strip mod.TPA-9) • **DE** Elektrische Multifunktionsbratpfanne fest Becken cm. 30x68x10h (inbegriffen 1 Abschluss-Element mod.TPA-9) • **FR** Sauteuse fixe multifonction électrique Cuve cm. 30x68x10h (inclus 1 Élément de jonction top mod.TPA-9) • **ES** Sartén fija multifunción eléctrica Cuba cm. 30x68x10h (incluida 1 Chapa de cierre para top mod.TPA-9)
cm. 40x 90x 90h



⚡ $\frac{5,2 \text{ kW}}{400 \text{ V~} - 3 \text{ N}}$ **3.898,00**
 $\frac{79}{50/60 \text{ Hz}}$ / 0,46

BRF-98ET BRASIERA FISSA MULTIFUNZIONALE ELETTRICA VASCA CM.
09070833 **70X68X10H (INCLUSA 1 TESTATA CHIUSURA PIANO MOD. TPA-9)**

EN Electric multi-function fixed braising pan - Bowl cm. 70x68x10h (included 1 Head end filler strip mod.TPA-9) • **DE** Elektrische Multifunktionsbratpfanne fest - Becken cm. 70x68x10h (inbegriffen 1 Abschluss-Element mod.TPA-9) • **FR** Sauteuse fixe multifonction électrique - Cuve cm. 70x68x10h (inclus 1 Élément de jonction top mod.TPA-9) • **ES** Sartén fija multifunción eléctrica - Cuba cm. 70x68x10h (incluida 1 Chapa de cierre para top mod.TPA-9)
cm. 80x 90x 90h



⚡ $\frac{10,4 \text{ kW}}{400 \text{ V~} - 3 \text{ N}}$ **5.632,00**
 $\frac{126}{50/60 \text{ Hz}}$ / 0,89

BRF-94G BRASIERA FISSA MULTIFUNZIONALE GAS VASCA CM.
09240453 **30X68X10H (INCLUSA 1 TESTATA CHIUSURA PIANO MOD. TPA-9)**

EN Gas multi-function fixed braising pan - Bowl cm. 30x68x10h (included 1 Head end filler strip mod.TPA-9) • **DE** Gas-Multifunktionsbratpfanne fest - Becken cm. 30x68x10h (inbegriffen 1 Abschluss-Element mod.TPA-9) • **FR** Sauteuse fixe multifonction à gaz - Cuve cm. 30x68x10h (inclus 1 Élément de jonction top mod.TPA-9) • **ES** Sartén fija multifunción a gas - Cuba cm. 30x68x10h (incluida 1 Chapa de cierre para top mod.TPA-9)
cm. 40x 90x 90h



⚡ $\frac{9 \text{ kW}}{7.740 \text{ kcal/h}}$ **4.624,00**
79 / 0,46

BRF-98G BRASIERA FISSA MULTIFUNZIONALE GAS VASCA CM.
09240853 **70X68X10H (INCLUSA 1 TESTATA CHIUSURA PIANO MOD. TPA-9)**

EN Gas multi-function fixed braising pan - Bowl cm. 70x68x10h (included 1 Head end filler strip mod.TPA-9) • **DE** Gas-Multifunktionsbratpfanne fest - Becken cm. 70x68x10h (inbegriffen 1 Abschluss-Element mod.TPA-9) • **FR** Sauteuse fixe multifonction à gaz - Cuve cm. 70x68x10h (inclus 1 Élément de jonction top mod.TPA-9) • **ES** Sartén fija multifunción a gas - Cuba cm. 70x68x10h (incluida 1 Chapa de cierre para top mod.TPA-9)
cm. 80x 90x 90h



⚡ $\frac{18 \text{ kW}}{15.480 \text{ kcal/h}}$ **6.603,00**
129 / 0,89

BRASIERE RIBALTABILI ELETTRICHE

MOD. _____
COD. _____

DESCRIZIONE/DESCRIPTION/BEZEICHNUNG/DESCRIPTION/DESCRIPCIÓN
DIMENSIONI/DIMENSIONS/ABMESSUNGEN/DIMENSIONS/DIMENSIONES

POTENZA/POWER/LEISTUNG/PUISSANCE/POTENCIA
VOLTAGGIO/VOLTAGE/SPANNUNG/VOLTAGE/VOLTAJE

⚡ kW kcal/h
⚡ kw V~ Hz

PREZZO/PRICE
PREIS/PRIX/PRECIO
KG / M³



BR120-912ET/I BRASIERA A RIBALTAMENTO MANUALE, VASCA 120 LITRI
09071235 **CM. 110X56X22,5H, FONDO INOX CON COPERCHIO**

EN Braising pan with manual tilting, bowl 120 lt. cm.110x56x22,5h, Stainless steel bottom with lid • **DE** Kippbratpfanne mit manual Kippung, 120 Lt. cm.110x56x22,5h, boden aus crnst. mit deckel • **FR** Sauteuse avec basculement manuel, cuve 120 lt. cm.110x56x22,5h, fond inox avec couvercle • **ES** Sartén con levantamiento manual, cuba 120 lt. cm.110x56x22,5h, fondo de acero inox con tapa
cm. 120x 90x 90h



⚡ 18 kW **10.057,00**
400V~3N 205 / 1,32
50/60 Hz

BRM120-912ET/I BRASIERA A RIBALTAMENTO AUTOMATICO, VASCA 120 LITRI
09071236 **CM. 110X56X22,5H, FONDO INOX CON COPERCHIO**

EN Braising pan with automatic tilting, bowl 120 lt. cm.110x56x22,5h, Stainless steel bottom with lid • **DE** Kippbratpfanne mit automatisch Kippung, 120 Lt. cm.110x56x22,5h, boden aus crnst. mit deckel • **FR** Sauteuse avec basculement automatique, cuve 120 lt. cm.110x56x22,5h, fond inox avec couvercle • **ES** Sartén con levantamiento automatico, cuba 120 lt. cm.110x56x22,5h, fondo de acero inox con tapa
cm. 120x 90x 90h



⚡ 18,1 kW **11.573,00**
400V~3N 211 / 1,32
50 Hz

BR120-912GF/I BRASIERA A RIBALTAMENTO MANUALE, VASCA 120 LITRI
09241255 **CM. 110X56X22,5H, FONDO INOX CON COPERCHIO**

EN Braising pan with manual tilting, bowl 120 lt. cm.110x56x22,5h, Stainless steel bottom with lid • **DE** Kippbratpfanne mit manual Kippung, 120 Lt. cm.110x56x22,5h, boden aus crnst. mit deckel • **FR** Sauteuse avec basculement manuel, cuve 120 lt. cm.110x56x22,5h, fond inox avec couvercle • **ES** Sartén con levantamiento manual, cuba 120 lt. cm.110x56x22,5h, fondo de acero inox con tapa
cm. 120x 90x 90h



⚡ 30 kW **10.085,00**
25.800 kcal/h 208 / 1,32

BRM120-912GF/I BRASIERA A RIBALTAMENTO AUTOMATICO, VASCA 120 LITRI
09241256 **CM. 110X56X22,5H, FONDO INOX CON COPERCHIO**

EN Braising pan with automatic tilting, bowl 120 lt. cm.110x56x22,5h, Stainless steel bottom with lid • **DE** Kippbratpfanne mit automatisch Kippung, 120 Lt. cm.110x56x22,5h, boden aus crnst. mit deckel • **FR** Sauteuse avec basculement automatique, cuve 120 lt. cm.110x56x22,5h, fond inox avec couvercle • **ES** Sartén con levantamiento automatico, cuba 120 lt. cm.110x56x22,5h, fondo de acero inox con tapa
cm. 120x 90x 90h



⚡ 30 KW **12.019,00**
25.800 kcal/h 214 / 1,32

PL-92 PIANO LAVORO SU MOBILE (INCLUSA 1 TESTATA CHIUSURA
09010200 **PIANO MOD.TPA-9)**

EN Worktop on cabinet (included 1 Head end filler strip mod.TPA-9)
• **DE** Arbeitsplatte mit Unterbau (inbegriffen 1 Abschluss-Element mod. TPA-9) • **FR** Plan de travail sur armoire (inclus 1 Élément de jonction top mod.TPA-9) • **ES** Sobre de trabajo sobre mueble (incluida 1 Chapa de cierre para top mod.TPA-9)
cm. 20x 90x 90h



1.033,00
45 / 0,46

PLS-93 PIANO LAVORO SU MOBILE A GIORNO (INCLUSA 1 TESTATA
09010301 **CHIUSURA PIANO MOD.TPA-9)**

EN Worktop on open cabinet (included 1 Head end filler strip mod.TPA-9)
• **DE** Arbeitsplatte mit offenem Unterbau (inbegriffen 1 Abschluss-Element mod.TPA-9) • **FR** Plan de travail sur armoire ouvert (inclus 1 Élément de jonction top mod.TPA-9) • **ES** Sobre de trabajo sobre mueble abierto (incluida 1 Chapa de cierre para top mod.TPA-9)
cm. 30x 90x 90h



1.054,00
47 / 0,46

PIANI LAVORO

MOD. _____
COD. _____

DESCRIZIONE/DESCRIPTION/BEZEICHNUNG/DESCRIPTION/DESCRIPCIÓN
DIMENSIONI/DIMENSIONS/ABMESSUNGEN/DIMENSIONS/DIMENSIONES

POTENZA/POWER/LEISTUNG/PUISSANCE/POTENCIA
VOLTAGGIO/VOLTAGE/SPANNUNG/VOLTAGE/VOLTAJE

⚡ kW kcal/h
⚡ kw V~ Hz

PREZZO/PRICE
PREIS/PRIX/PRECIO
KG / M³



PLS-94
09010401

cm. 40x 90x 90h



1.070,00
49 / 0,46

PLS-96
09010601

cm. 60x 90x 90h



1.591,00
59 / 0,48

PLS-98
09010801

cm. 80x 90x 90h



1.689,00
70 / 0,89

PL-93
09010300

PIANO LAVORO SU MOBILE A GIORNO CASSETTO CM. 19X50X15H INOX (INCLUSA 1 TESTATA CHIUSURA PIANO MOD.TPA-9)

EN Worktop on open cabinet Drawer cm. 19x50x15h (included 1 Head end filler strip mod.TPA-9) • **DE** Arbeitsplatte mit offenem Unterbau. Schublade cm. 19x50x15h (inbegriffen 1 Abschluss-Element mod.TPA-9) • **FR** Plan de travail sur armoire ouvert. Tiroir inox cm. 19x50x15h (inclus 1 Élément de jonction top mod.TPA-9) • **ES** Sobre de trabajo con mueble abierto. Cajón cm. 19x50x15h inox (incluida 1 Chapa de cierre para top mod.TPA-9)

cm. 30x 90x 90h



1.337,00
50 / 0,46

PL-94
09010400

PIANO LAVORO SU MOBILE A GIORNO CASSETTO CON 1 BACINELLA GN 1/1 15H IN PLASTICA (INCLUSA 1 TESTATA CHIUSURA PIANO MOD.TPA-9)

EN Worktop on open cabinet Drawer with 1 plastic container GN 1/1 15h (included 1 Head end filler strip mod.TPA-9) • **DE** Arbeitsplatte mit offenem Unterbau Schublade mit 1 GN 1/1 15h Kunststoffbehälter (inbegriffen 1 Abschluss-Element mod.TPA-9) • **FR** Plan de travail sur armoire ouvert Tiroir avec bac en plastique GN 1/1 15h (inclus 1 Élément de jonction top mod.TPA-9) • **ES** Sobre de trabajo sobre mueble abierto Cajón con 1 contenedor GN 1/1 15h plástico (incluida 1 Chapa de cierre para top mod.TPA-9)

cm. 40x 90x 90h



1.309,00
54 / 0,46

PL-96
09010600

PIANO LAVORO SU MOBILE A GIORNO CASSETTO CM. 49X50X15H INOX (INCLUSA 1 TESTATA CHIUSURA PIANO MOD.TPA-9)

EN Worktop on open cabinet Drawer cm. 49x50x15h (included 1 Head end filler strip mod.TPA-9) • **DE** Arbeitsplatte mit offenem Unterbau. Schublade cm. 49x50x15h (inbegriffen 1 Abschluss-Element mod.TPA-9) • **FR** Plan de travail sur armoire ouvert. Tiroir inox cm. 49x50x15h (inclus 1 Élément de jonction top mod.TPA-9) • **ES** Sobre de trabajo con mueble abierto. Cajón cm. 49x50x15h inox (incluida 1 Chapa de cierre para top mod.TPA-9)

cm. 60x 90x 90h



1.855,00
70 / 0,68

MOD. _____
COD. _____

DESCRIZIONE/DESCRIPTION/BEZEICHNUNG/DESCRIPTION/DESCRIPCIÓN
DIMENSIONI/DIMENSIONS/ABMESSUNGEN/DIMENSIONS/DIMENSIONES

POTENZA/POWER/LEISTUNG/PUISSANCE/POTENCIA
VOLTAGGIO/VOLTAGE/SPANNUNG/VOLTAGE/VOLTAJE

↓ kW kcal/h
↗ kW V~ Hz

PREZZO/PRICE
PREIS/PRIX/PRECIO
KG / M³



PL-98
09010800

PIANO LAVORO SU MOBILE A GIORNO CASSETTO CON 2 BACINELLE GN 1/1 15H IN PLASTICA (INCLUSA 1 TESTATA CHIUSURA PIANO MOD.TPA-9)
EN Worktop on open cabinet Drawer with 2 plastic containers GN 1/1 15h (included 1 Head end filler strip mod.TPA-9) • **DE** Arbeitsplatte mit offenem Unterbau Schublade mit 2 GN 1/1 15h Kunststoffbehälter (inbegriffen 1 Abschluss-Element mod.TPA-9) • **FR** Plan de travail sur armoire ouvert tiroir avec 2 bacs en plastique GN 1/1 15h (inclus 1 Élément de jonction top mod.TPA-9) • **ES** Sobre de trabajo sobre mueble abierto Cajón con 2 contenedores GN 1/1 15h plástico (incluida 1 Chapa de cierre para top mod.TPA-9)
cm. 80x 90x 90h



1.980,00
82 / 0,89

LA-94
09020400

LAVELLO SU MOBILE A GIORNO RUBINETTO A LEVA - VASCA CM. 30X35X15H (INCLUSA 1 TESTATA CHIUSURA PIANO MOD.TPA-9)
EN Sink unit on open cabinet - Lever type tap. Bowl cm. 30x35x15h (included 1 Head end filler strip mod.TPA-9) • **DE** Spülbecken Einhebel-Mischbatterie mit offenem Unterbau - Becken cm. 30x35x15h (inbegriffen 1 Abschluss-Element mod.TPA-9) • **FR** Bac-évier sur armoire ouvert avec robinetterie - Bac cm. 30x35x15h (inclus 1 Élément de jonction top mod.TPA-9) • **ES** Fregadero sobre mueble abierto - Grifo a palanca - Pileta cm. 30x35x15h (incluida 1 Chapa de cierre para top mod.TPA-9)
cm. 40x 90x 90h



1.551,00
53 / 0,46

P-73/93-DX
08430300

PORTA 300 DESTRA
EN Right door 300 • **DE** Rechte tür 300 • **FR** Porte droite 300 • **ES** Puerta derecha 300
cm. 29,5x 2,5x 47,5h



197,00
3 / 0,01

P-74/94-DX
08430400

PORTA 400 DESTRA
EN Right door 400 • **DE** Rechte tür 400 • **FR** Porte droite 400 • **ES** Puerta derecha 400
cm. 39,5x 2,5x 47,5h



204,00
3.5 / 0,02

P-73/93-SX
08430301

PORTA 300 SINISTRA
EN Left door 300 • **DE** Linke tür 300 • **FR** Porte gauche 300 • **ES** Puerta izquierda 300
cm. 29,5x 2,5x 47,5h



197,00
3 / 0,01

P-74/94-SX
08430401

PORTA 400 SINISTRA
EN Left door 400 • **DE** Linke tür 400 • **FR** Porte gauche 400 • **ES** Puerta izquierda 400
cm. 39,5x 2,5x 47,5h

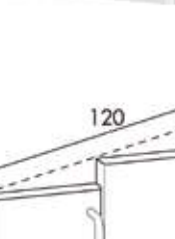

204,00
3.5 / 0,02

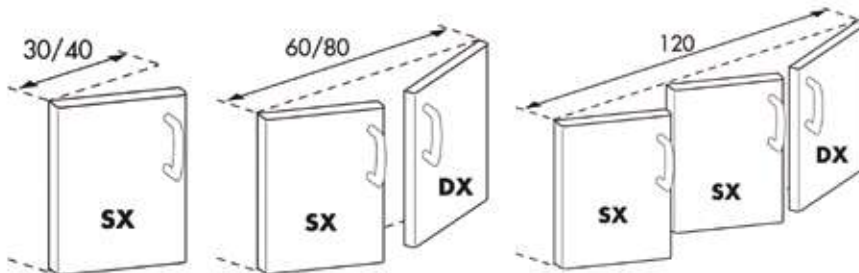

ACCESSORI

MOD. _____
COD. _____

DESCRIZIONE/DESCRIPTION/BEZEICHNUNG/DESCRIPTION/DESCRIPCIÓN
DIMENSIONI/DIMENSIONS/ABMESSUNGEN/DIMENSIONS/DIMENSIONES

POTENZA/POWER/LEISTUNG/PUISSANCE/POTENCIA
VOLTAGGIO/VOLTAGE/SPANNUNG/VOLTAGE/VOLTAJE

↓ kW kcal/h
↑ kW V~ Hz

PREZZO/PRICE
PREIS/PRIX/PRECIO
KG / M³



C-73/93
08440320

CASSETTIERA 300 N. 2 CASSETTI CON 2 BACINELLE INOX, GUIDE TELESCOPICHE. SOLO SU PL
EN Drawer set 300 N. 2 drawers with 2 inox containers, telescopic guides. Only for PL • **DE** Schubladen 300 - N. 2 Schubladen mit 2 Chromnickelstahlbehältern, Telescopeinführungen. Nur für PL • **FR** Tiroirs pour meuble de 300 N. 2 tiroirs avec 2 bacs inox, guides télescopiques. Seulement pour PL • **ES** Cajonera 300 - N. 2 cajones con 2 contenedores de acero inox, guías telescópicas. Solo para PL
cm. 29,5x 59x 47,5h



766,00
16 / 0,19

C-74/94
08440420

CASSETTIERA 400 - N. 2 CASSETTI CON 2 BACINELLE GN 1/1 15H IN PLASTICA, GUIDE TELESCOPICHE. SOLO SU PL
EN Drawer set 400 - N. 2 drawers with 2 GN 1/1 15h plastic containers, telescopic guides. Only for PL • **DE** Schubladen - N. 2 Schubladen mit 2 GN 1/1 15h Kunststoffbehältern, Telescopeinführungen. Nur für PL • **FR** Tiroirs pour meuble de 400 - N. 2 tiroirs avec 2 bacs en plastique GN 1/1 15h, guides télescopiques. Seulement pour PL • **ES** Cajonera 400 - N. 2 cajones con 2 contenedores GN 1/1 15h de plástico, guías telescópicas. Solo para PL
cm. 39,5x 59x 47,5h



786,00
18 / 0,19

C-76/96
08440620

CASSETTIERA 600 N. 2 CASSETTI CON 2 BACINELLE INOX, GUIDE TELESCOPICHE. SOLO SU PL
EN Drawer set 600 N. 2 drawers with 2 inox containers, telescopic guides. Only for PL • **DE** Schubladen 600 - N. 2 Schubladen mit 2 Chromnickelstahlbehältern, Telescopeinführungen. Nur für PL • **FR** Tiroirs pour meuble de 600 N. 2 tiroirs avec 2 bacs inox, guides télescopiques. Seulement pour PL • **ES** Cajonera 600 - N. 2 cajones con 2 contenedores de acero inox, guías telescópicas. Solo para PL
cm. 59,5x 59x 47,5h



1.086,00
22 / 0,28

C-78/98
08440820

CASSETTIERA 800 - N. 2 CASSETTI CON 4 BACINELLE GN 1/1 15H IN PLASTICA, GUIDE TELESCOPICHE. SOLO SU PL
EN Drawer set 800 - N. 2 drawers with 4 GN 1/1 15h plastic containers, telescopic guides. Only for PL • **DE** Schubladen 800 - N. 2 Schubladen mit 4 GN 1/1 15h Kunststoffbehältern, Telescopeinführungen. Nur für PL • **FR** Tiroirs pour meuble de 800 - N. 2 tiroirs avec 4 bacs en plastique GN 1/1 15h, guides télescopiques. Seulement pour PL • **ES** Cajonera 800 - N. 2 cajones con 4 contenedores GN 1/1 15h de plástico, guías telescópicas. Solo para PL
cm. 79,5x 59x 47,5h



1.105,00
26 / 0,37

D-9
09470000

DIVISORIO
EN Spacer • **DE** Trennwand • **FR** Separation • **ES** Divisorio
cm. 5x 79x 45h

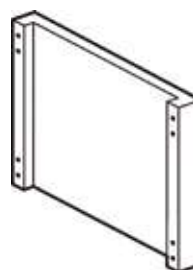

218,00
2,5 / 0,03

531070300 CESTO 1/1 PER CP-94/98 & CPB-98

EN Basket 1/1 for CP-94/98 & CPB-98 • **DE** Korb 1/1 für CP-94/98 & CPB-98 • **FR** Panier 1/1 pour CP-94/98 & CPB-98 • **ES** Cesta 1/1 para CP-94/98 & CPB-98
cm. 28x 49x 21,5h



248,00
3,5 / 0,08

ACCESSORI CUOCIPASTA

MOD. _____
COD. _____

DESCRIZIONE/DESCRIPTION/BEZEICHNUNG/DESCRIPTION/DESCRIPCIÓN
DIMENSIONI/DIMENSIONS/ABMESSUNGEN/DIMENSIONS/DIMENSIONES

POTENZA/POWER/LEISTUNG/PUISSANCE/POTENCIA
VOLTAGGIO/VOLTAGE/SPANNUNG/VOLTAGE/VOLTAJE

↓ kW kcal/h
↗ kW V~ Hz

PREZZO/PRICE
PREIS/PRIX/PRECIO
KG / M³



531070200 CESTO 2/3 PER CP-94/98 & CPB-98

EN Basket 2/3 for CP-94/98 & CPB-98 • **DE** Korb 2/3 für CP-94/98 & CPB-98 • **FR** Panier 2/3 pour CP-94/98 & CPB-98 • **ES** Cesta 2/3 para CP-94/98 & CPB-98
cm. 28x 32x 21,5h



171,00
2 / 0,06

531070100 CESTO 1/2 PER CP-94/98 & CPB-98

EN Basket 1/2 for CP-94/98 & CPB-98 • **DE** Korb 1/2 für CP-94/98 & CPB-98 • **FR** Panier 1/2 pour CP-94/98 & CPB-98 • **ES** Cesta 1/2 para CP-94/98 & CPB-98
cm. 28x 24x 21,5h



155,00
1 / 0,05

531047900 CESTO 1/3 PER CP-94/98 & CPB-98

EN Basket 1/3 for CP-94/98 & CPB-98 • **DE** Korb 1/3 für CP-94/98 & CPB-98 • **FR** Panier 1/3 pour CP-94/98 & CPB-98 • **ES** Cesta 1/3 para CP-94/98 & CPB-98
cm. 28x 16x 21,5h



123,00
1.5 / 0,04

531048000 CESTO 1/6 PER CP-94/98 & CPB-98

EN Basket 1/6 for CP-94/98 & CPB-98 • **DE** Korb 1/6 für CP-94/98 & CPB-98 • **FR** Panier 1/6 pour CP-94/98 & CPB-98 • **ES** Cesta 1/6 para CP-94/98 & CPB-98
cm. 13,5x 16x 21,5h



94,00
1 / 0,02

CBTEST

"CB TEST CERTIFICATE" PER APPARECCHI: FT-94/98ET**, PC/PCT/PCQ/PCQT-94/98/912/916ET, CF4/CFQ4-98ET, CF6/CQ6-912ET/ETV, CF8/CQ8-912ET/ETV, F18/25-94ET, F2/18-98ET, F2/25-98ET**

EN "CB TEST CERTIFICATE" for model: FT**-94/98ET**, PC/PCT/PCQ/PCQT-94/98/912/916ET, CF4/CFQ4-98ET, CF6/CQ6-912ET/ETV, CF8/CQ8-912ET/ETV, F18/25-94ET, F2/18-98ET, F2/25-98ET • **DE** "CB TEST CERTIFICATE" für modell: FT**-94/98ET**, PC/PCT/PCQ/PCQT-94/98/912/916ET, CF4/CFQ4-98ET, CF6/CQ6-912ET/ETV, CF8/CQ8-912ET/ETV, F18/25-94ET, F2/18-98ET, F2/25-98ET • **FR** "CB TEST CERTIFICATE" pour modèle: FT**-94/98ET**, PC/PCT/PCQ/PCQT-94/98/912/916ET, CF4/CFQ4-98ET, CF6/CQ6-912ET/ETV, CF8/CQ8-912ET/ETV, F18/25-94ET, F2/18-98ET, F2/25-98ET • **ES** "CB TEST CERTIFICATE" para modelo: FT**-94/98ET**, PC/PCT/PCQ/PCQT-94/98/912/916ET, CF4/CFQ4-98ET, CF6/CQ6-912ET/ETV, CF8/CQ8-912ET/ETV, F18/25-94ET, F2/18-98ET, F2/25-98ET

CB

186,00
/

ACCESSORI

MOD.
COD.

DESCRIZIONE/DESCRIPTION/BEZEICHNUNG/DESCRIPTION/DESCRIPCIÓN
DIMENSIONI/DIMENSIONS/ABMESSUNGEN/DIMENSIONS/DIMENSIONES

POTENZA/POWER/LEISTUNG/PUISSANCE/POTENCIA
VOLTAGGIO/VOLTAGE/SPANNUNG/VOLTAGE/VOLTAJE

↓ kW kcal/h
↗ kW V~ Hz

PREZZO/PRICE
PREIS/PRIX/PRECIO
KG / M³



CEA
09580010

COLONNINA EROGAZIONE ACQUA
EN Pillar tap • **DE** Mischbatterie • **FR** Colonne de distribution eau
• **ES** Rubineto dispensador de agua



425,00
6 / 0,05

CEAT
19580010

COLONNINA EROGAZIONE ACQUA TOP
EN Pillar tap top • **DE** Mischbatterie top • **FR** Colonne de distribution eau top • **ES** Rubineto dispensador de agua top

425,00
5 / 0,04

531047100

GRIGLIA IN TONDINO 2 FUOCHI (SERIE 90)
EN grid rod 2 burner (90 line) • **DE** Gitterstab 2 Brenner (90. Serie)
• **FR** tige grille 2 feux (serie 90) • **ES** red de varilla 2 quemador (serie 90)



214,00
9 / 0,03

09570401

GRIGLIA TONDINO PER CW (SERIE 90)
EN Grid for CW (90 line) • **DE** Gitter für CW (90. Serie) • **FR** Grille ronde pour CW (serie 90) • **ES** Rejilla para CW (serie 90)
cm. 36x 68



560,00
12 / 0,03

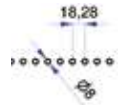

09570402

GRIGLIA TEGOLO V PER CW (SERIE 90)
EN Grid V for CW (90 line) • **DE** Gitter V für CW (90. Serie) • **FR** Grille V pour CW (serie 90) • **ES** Rejilla V para CW (serie 90)
cm. 36x 68



560,00
12 / 0,03

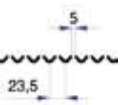

544023800

RASCHIETTO PER PIASTRA RIGATA
EN Scraper for gooved plate • **DE** Schaber für gerillte Kochplatte • **FR** Racloir pour plaque nervurée • **ES** Rasqueta para placa ranurada



64,00
/ 1,00

531040800

RASCHIETTO PER PIASTRA LISCIA AL CROMO LUCIDO
EN Scraper for smooth POLISHED CHROME plate • **DE** Schaber für glatte POLIERTEM CHROM Platte • **FR** Racloir pour plaque lisse au CHROME POLI • **ES** Rasqueta para placa lisa de CROMO PULIDO



58,00
/ 1,00

531040900

KIT 10 LAME PER RASCHIETTO COD.531040800
EN 10 blades kit for scraper cod.531040800 • **DE** Kit 10 klingen für Schaber cod.531040800 • **FR** Kit de 10 lames pour racloir cod.531040800 • **ES** Kit de 10 cuchillas para rasqueta cod.531040800

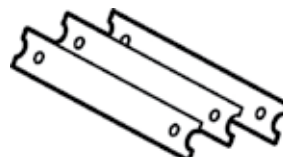

42,00
/ 0,00

ACCESSORI FRY-TOP

MOD. _____
COD. _____

DESCRIZIONE/DESCRIPTION/BEZEICHNUNG/DESCRIPTION/DESCRIPCIÓN
DIMENSIONI/DIMENSIONS/ABMESSUNGEN/DIMENSIONS/DIMENSIONES

POTENZA/POWER/LEISTUNG/PUISSANCE/POTENCIA
VOLTAGGIO/VOLTAGE/SPANNUNG/VOLTAGE/VOLTAJE

⚡ kW kcal/h
⚡ kw V~ Hz

PREZZO/PRICE
PREIS/PRIX/PRECIO
KG / M³



T-FT
09580060

TAPPO PER FRY-TOP
EN stopper for Fry-top • **DE** Stopfen griddleplatte • **FR** bouchon pour Plaque • **ES** tapón Fry-top
cm. 10x 2x 5h



248,00
/ 0,00

PFT-94
09620400

KIT PROTEZIONE FRONTALE PIANO FRY-TOP
EN KIT front protection plan fry-top • **DE** Schutz-kit vorne Plan griddleplatte • **FR** KIT protection avant plan plaque • **ES** KIT de protección frontal plan de fry-top
cm. 35x 11x 6h

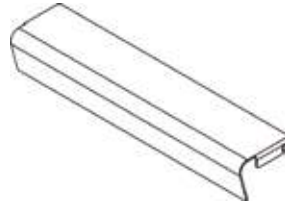

168,00
/ 0,00

PFT-98
09620800

cm. 75x 11x 6h

279,00
/ 0,01

KF-F-ETD S90
546003502

KIT 100 FILTRI 5 MICRON PER F-ETDP S90
EN KIT 100 sieve 5 microns for F-ETDP S90 • **DE** KIT 100 Filter 5-Mikron für F-ETDP S90 • **FR** KIT 100 filtre 5 microns pour F-ETDP S90 • **ES** KIT 100 filtro de 5 micrones para F-ETDP S90



401,00
0.1 / 0,00

531041600

CESTINO 1/2 PER F18-E (STANDARD IN F18-ETD)
EN Basket 1/2 for F18-E (standard F18-ETD) • **DE** Korb 1/2 zur Friteuse F18-E (standard F18-ETD) • **FR** Panier 1/2 pour F18-E (standard F18-ETD) • **ES** Cesta 1/2 para F18-E (standard F18-ETD)
cm. 13,5x 29x 15h



78,00
0.8 / 0,04

531041500

CESTINO 1/2 PER F18-90G
EN Basket 1/2 for F18-90G • **DE** Korb 1/2 für Friteuse F18-90G • **FR** Panier 1/2 pour F18-90G • **ES** Cesta 1/2 para F18-90G
cm. 10x 45x 15h



78,00
0.8 / 0,04

531041400

CESTINO 1/1 PER F25-G/E + F25-ETD
EN Basket 1/1 for F25-G/E + F25-ETD • **DE** Korb 1/1 für Friteuse F25-G/E + F25-ETD • **FR** Panier 1/1 pour F25-G/E + F25-ETD • **ES** Cesta 1/1 para F25-G/E + F25-ETD
cm. 28x 45x 15h



135,00
1.5 / 0,07

ACCESSORI FRIGGITRICI

MOD. _____
COD. _____

DESCRIZIONE/DESCRIPTION/BEZEICHNUNG/DESCRIPTION/DESCRIPCIÓN
DIMENSIONI/DIMENSIONS/ABMESSUNGEN/DIMENSIONS/DIMENSIONES

POTENZA/POWER/LEISTUNG/PUISSANCE/POTENCIA
VOLTAGGIO/VOLTAGE/SPANNUNG/VOLTAGE/VOLTAJE

⚡ kW _____
kcal/h _____
⚡ kW _____
V~ _____
Hz _____

PREZZO/PRICE
PREIS/PRIX/PRECIO
KG / M³



531041300 CESTINO 1/1 PER F18-ETD (STANDARD IN F18-E)
EN Basket 1/1 for F18-ETD (standard F18-E) • **DE** korb 1/1 für F18-ETD (standard F18-E) • **FR** Panier 1/1 pour F18-ETD (standard F18-E)
 • **ES** Cesta 1/1 para F18-ETD (standard F18-E)
cm. 28x 29x 15h



84,00
1.5 / 0,06

KITSS-90 09580050 KIT SCIoglimento STRUTTO, SOLO PER FRIGGITRICI ELETTRICHE A MOBILE.
EN Kit for lard melting, only for electric fryers on cabinet • **DE** Satz fuer schmalzschmelzen, nur für elektrische Friteusen mit unterbau • **FR** Kit de dissolution lard, seulement pour les friteuses électriques sur armoire • **ES** kit de disolución de manteca, sólo para freidoras eléctricas on mueble

⚡ 0,31 KW _____
_____ / 0,01

BF30 09580030 BACINELLA RACCOGLI OLIO CON FILTRO LT. 30 PER FRIGGITRICE
EN 30 lts. oil collecting tray - With filter for deep fryer • **DE** Ölauffangwanne mit Filter, 30 Liter, für Friteuse • **FR** Bac de récupération de l'huile Avec filtre 30 lt. pour friteuse • **ES** Bandeja para aceite con filtro - 30 lt. para freidora
cm. 29x 29x 37h



223,00
7 / 0,10

09550400 COPERCHIO PER BRF-94
EN Lid for BFR-94 • **DE** Deckel für BFR-94 • **FR** Couvercle pour BFR-94
 • **ES** Tapa para BFR-94
cm. 32x 70x 5h



143,00
2.5 / 0,01

09550800 COPERCHIO PER BRF-98
EN Lid for BFR-98 • **DE** Deckel für BFR-98 • **FR** Couvercle pour BFR-98
 • **ES** Tapa para BFR-98
cm. 72x 70x 5h

190,00
5 / 0,02

TG-94 09580400 TAGLIERE PLASTICA
EN Plastic chopping-board • **DE** Schneidebrett • **FR** Plan de decoupe
 • **ES** Picador de plástico
cm. 39x 75x 2,5h

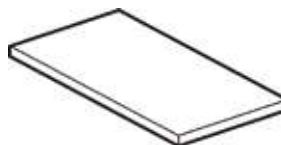

151,00
8 / 0,01

TG-98 09580800
cm. 79x 75x 2,5h

304,00
14 / 0,03

PLF/9 09590401 PIASTRA LISCIA PER GRIGLIA IN GHISA
EN Smooth griddle plate for cast iron grid • **DE** Fortkochplatte glatt für Gusseisen Rost • **FR** Plaque lisse pour la grille en fonte • **ES** Plancha lisa para rejilla de hierro fundido
cm. 36x 39



200,00
11 / 0,01

PRF/9 09590403 PIASTRA RIGATA PER GRIGLIA IN GHISA
EN Grooved griddle plate for cast iron grid • **DE** Fortkochplatte gerillt für Gusseisen Rost • **FR** Plaque nervurée pour la grille en fonte • **ES** Plancha estriada para rejilla de hierro fundido
cm. 36x 39



269,00
11 / 0,01

ACCESSORI

MOD. _____
COD. _____

DESCRIZIONE/DESCRIPTION/BEZEICHNUNG/DESCRIPTION/DESCRIPCIÓN
DIMENSIONI/DIMENSIONS/ABMESSUNGEN/DIMENSIONS/DIMENSIONES

POTENZA/POWER/LEISTUNG/PUISSANCE/POTENCIA
VOLTAGGIO/VOLTAGE/SPANNUNG/VOLTAGE/VOLTAJE

⚡ kW _____
kcal/h _____
V~ _____
Hz _____

PREZZO/PRICE
PREIS/PRIX/PRECIO
KG / M³



PLFT/9
09590451

PIASTRA LISCIA PER GRIGLIA IN TONDINO
EN Smooth griddle plate for grid rod • **DE** Fortkochplatte glatt für Gitterstab • **FR** Plaque lisse pour tige grille • **ES** Plancha lisa por red de varilla
cm. 36x 39



194,00
11 / 0,01

PRFT/9
09590453

PIASTRA RIGATA PER GRIGLIA IN TONDINO
EN Grooved griddle plate for grid rod • **DE** Fortkochplatte gerillt für Gitterstab • **FR** Plaque nervurée pour tige grille • **ES** Plancha estriada por red de varilla
cm. 36x 39



259,00
11 / 0,01

533009200

GRIGLIA DI RIDUZIONE
EN Reduction • **DE** Reduzierstern • **FR** Grille de réduction • **ES** Rejilla de reducción
cm. 25x 25

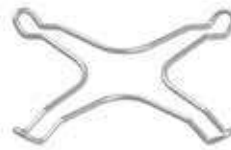

40,00
0.2 / 0,00

KIT-WOK
09580040

KIT WOK - FIAMMA VERTICALE - SOLO SU BRUCIATORE DA 10 KW E GRIGLIE IN GHISA
EN KIT WOK - vertical flame - only for 10 kW burner and cast iron grills • **DE** KIT WOK - vertikaler Flamme - nur 10 kW-Brenner und Roste aus Gusseisen • **FR** KIT WOK - verticale de la flamme - seulement 10 kW brûleur et grilles en fonte • **ES** KIT WOK - llama vertical - sólo 10 kW quemador y parrilas de hierro colado
cm. Ø 26x 16h



422,00
5 / 0,02

544439900

ANELLO PER WOK - SOLO PER GRIGLIE IN GHISA
EN Wok ring - only for cast iron grills • **DE** Wok Aufsatzring - nur für Roste aus Gusseisen • **FR** Anneau Wok - seulement pour grilles en fonte • **ES** Anillo Wok - solo para parrilas de hierro colado
cm. Ø22,5x 3,5h



157,00
2 / 0,00

RV
08660410

RISCALDANTE VANO CUCINA
EN Heater for range's cabinet • **DE** Heizer für Herden-Schränkelement • **FR** Réchauffeur pour armoire du fourneau • **ES** Calefacción para armario neutro de la cocina
cm. 32x 48,5x 8h



⚡ 0,75 kW _____
230V~ _____
50/60 Hz _____

903,00
8 / 0,08

RCRV-94
09450402

RIPIANO FORATO IN APPOGGIO PER RISCALDANTE SU VANO CUCINA
EN Perforated shelf for heater element mod.RV for cooker cabinet • **DE** regale Gelocht für Heizer mod.RV für Herden-Schränkelement • **FR** Étagère perforées pour réchauffeur mod.RV pour armoire du fourneau • **ES** estante perforado para elemento de calefaccion mod.RV para armario neutro de la cocina
cm. 34x 75x 10h



473,00
6 / 0,04

RRV-94
09450401

RIPIANO FORATO IN APPOGGIO PER RISCALDANTE
EN Perforated shelf for heater element mod.RV • **DE** regale Gelocht für Heizer mod.RV • **FR** Étagère perforées pour réchauffeur mod.RV • **ES** estante perforado para elemento de calefaccion mod.RV
cm. 34x 77x 10h

473,00
6 / 0,04

RRV-96
09450601

cm. 54x 77x 10h

823,00
9 / 0,06

RRV-98
09450801

cm. 74x 77x 10h

903,00
11 / 0,08

ACCESSORI

MOD. _____
COD. _____

DESCRIZIONE/DESCRIPTION/BEZEICHNUNG/DESCRIPTION/DESCRIPCIÓN
DIMENSIONI/DIMENSIONS/ABMESSUNGEN/DIMENSIONS/DIMENSIONES

POTENZA/POWER/LEISTUNG/PUISSANCE/POTENCIA
VOLTAGGIO/VOLTAGE/SPANNUNG/VOLTAGE/VOLTAJE

$\frac{kW}{kcal/h}$ $\frac{kw}{V\sim}$
Hz

PREZZO/PRICE
PREIS/PRIX/PRECIO
KG / M³



RRV-910 09451001	cm. 94x 77x 10h		1.278,00 14 / 0,10
RRV-912 09451201	cm. 114x 77x 10h		1.535,00 17 / 0,12
RRV-916 09451601	cm. 154x 77x 10h		2.091,00 22 / 0,16

PT-74/94 08460002	PORTATEGLIE VANO 400 (GN-1/1) VANO 600 (GN-2/1) 4 RIPIANI INT. 7 CM. EN Frame for plates 400 (GN-1/1) 600 (GN-2/1) - N. 4 shelves, wheel-base 7 cm. • DE Auflangeschienen für bleche 400 (GN-1/1) 600 (GN-2/1) - N. 4 Etagen, Abstand 7 cm. • FR Kit porte-plaques 400 (GN-1/1) 600 (GN-2/1) - N. 4 étagères; 7 cm. • ES Portacazuelas 400 (GN-1/1) 600 (GN-2/1) - N. 4 estantes, int. 7 cm.		425,00 2.5 / 0,01
-----------------------------	--	--	-----------------------------

PT-78/98 08460012	PORTATEGLIE VANO 800 (GN-2/1) 4 RIPIANI INT. 7 CM. EN Frame for plates 800 (GN-2/1) 4 Etagen, Abstand 7 cm. • DE Auflangeschienen für bleche 800 (GN-2/1) N. 4 Etagen, Abstand 7 cm. • FR Kit porte-plaques 800 (GN-2/1) - N. 4 étagères; 7 cm. • ES Portacazuelas 800 (GN-2/1) - N. 4 estantes, int. 7 cm.		568,00 4 / 0,01
-----------------------------	---	--	---------------------------

09610400	MITRA 400 EN Chimney jack 400 • DE Lüftungsaufsatz 400 • FR Mitre 400 • ES Caperuza 400 cm. 40x 7x 92h		401,00 8 / 0,02
-----------------	--	---	---------------------------

09610800	MITRA 800 EN Chimney jack 800 • DE Lüftungsaufsatz 800 • FR Mitre 800 • ES Caperuza 800 cm. 80x 7x 92h		585,00 16 / 0,04
-----------------	--	--	----------------------------

09611200	MITRA 1200 EN Chimney jack 1200 • DE Lüftungsaufsatz 1200 • FR Mitre 1200 • ES Caperuza 1200 cm. 120x 7x 92h		782,00 24 / 0,06
-----------------	--	--	----------------------------

09610402	MITRA 400 PER CPP-94G EN Chimney jack 400 for CPP-94G • DE Lüftungsaufsatz 400 für CPP-94G • FR Mitre 400 pour CPP-94G • ES Caperuza 400 para CPP-94G cm. 40x 7x 73h		585,00 8 / 0,02
-----------------	--	--	---------------------------

09610401	CAMINO ANTIVENTO 400 EN Draught diverter 400 • DE Strömungssicherung 400 • FR Cheminee anti-vent 400 • ES Chimenea contra viento 400 cm. 40x 19x 120h		703,00 8 / 0,08
-----------------	---	--	---------------------------

09610801	CAMINO ANTIVENTO 800 EN Draught diverter 800 • DE Strömungssicherung 800 • FR Cheminee anti-vent 800 • ES Chimenea contra viento 800 cm. 80x 19x 120h		823,00 16 / 0,15
-----------------	---	--	----------------------------

09611201	CAMINO ANTIVENTO 1200 EN Draught diverter 1200 • DE Strömungssicherung 1200 • FR Cheminee anti-vent 1200 • ES Chimenea contra viento 1200 cm. 120x 19x 120h		1.086,00 24 / 0,25
-----------------	---	--	------------------------------

09610403	CAMINO ANTIVENTO 400 PER CPP-94G EN Draught diverter 400 for CPP-94G • DE Strömungssicherung 400 für CPP-94G • FR Cheminee anti-vent 400 pour CPP-94G • ES Chimenea contra viento 400 para CPP-94G cm. 40x 19x 98h		703,00 8 / 0,08
-----------------	--	--	---------------------------

ACCESSORI

MOD. _____
COD. _____

DESCRIZIONE/DESCRIPTION/BEZEICHNUNG/DESCRIPTION/DESCRIPCIÓN
DIMENSIONI/DIMENSIONS/ABMESSUNGEN/DIMENSIONS/DIMENSIONES

POTENZA/POWER/LEISTUNG/PUISSANCE/POTENCIA
VOLTAGGIO/VOLTAGE/SPANNUNG/VOLTAGE/VOLTAJE

⚡ kW kcal/h
⚡ kw V~ Hz

PREZZO/PRICE
PREIS/PRIX/PRECIO
KG / M³



SA-72/92 08600200	SCHIENA POSTERIORE A VISTA PER APPARECCHI EN Back cover • DE Ruckenwand • FR Dos de finition • ES panel posterior cm. 20x 1,5x 81h		104,00 2 / 0,01
SA-73/93 08600300	cm. 30x 1,5x 81h		118,00 3 / 0,01
SA-74/94 08600400	cm. 40x 1,5x 81h		135,00 3 / 0,01
SA-75/95 08600500	cm. 50x 1,5x 81h		170,00 4 / 0,01
SA-76/96 08600600	cm. 60x 1,5x 81h		196,00 4 / 0,02
SA-77/97 08600700	cm. 70x 1,5x 81h		208,00 5 / 0,02
SA-78/98 08600800	cm. 80x 1,5x 81h		229,00 5 / 0,02
SA-79/99 08600900	cm. 90x 1,5x 81h		257,00 6 / 0,02
SA-710/910 08601000	cm. 100x 1,5x 81h		285,00 6 / 0,03
SA-711/911 08601100	cm. 110x 1,5x 81h		316,00 7 / 0,03
SA-712/912 08601200	cm. 120x 1,5x 81h		344,00 7 / 0,03
SA-713/913 08601300	cm. 130x 1,5x 81h		373,00 8 / 0,03
SA-714/914 08601400	cm. 140x 1,5x 81h		400,00 8 / 0,04
SA-715/915 08601500	cm. 150x 1,5x 81h		428,00 10 / 0,04
SA-716/916 08601600	cm. 160x 1,5x 81h		456,00 10 / 0,04
SA-94CPPG 08600402	SCHIENA POSTERIORE A VISTA PER CUOCIPASTA GAS CPP-94G EN Back cover for Gas pasta cooker CPP-94G • DE Ruckenwand fur Gas-Nudelkocher CPP-94G • FR Dos de finition pour Cuiseur a pates gaz CPP-94G • ES panel posterior para Cuece pasta gas CPP-94G cm. 40x 1,5x 100h		156,00 3 / 0,01
SA-98CPPG 08600802	SCHIENA POSTERIORE A VISTA PER CUOCIPASTA GAS CPP-98G EN Back cover for Gas pasta cooker CPP-98G • DE Ruckenwand fur Gas-Nudelkocher CPP-98G • FR Dos de finition pour Cuiseur a pates gaz CPP-98G • ES panel posterior para Cuece pasta gas CPP-98G cm. 80x 1,5x 100h		249,00 6 / 0,03

ACCESSORI

MOD. _____
COD. _____

DESCRIZIONE/DESCRIPTION/BEZEICHNUNG/DESCRIPTION/DESCRIPCIÓN
DIMENSIONI/DIMENSIONS/ABMESSUNGEN/DIMENSIONS/DIMENSIONES

POTENZA/POWER/LEISTUNG/PUISSANCE/POTENCIA
VOLTAGGIO/VOLTAGE/SPANNUNG/VOLTAGE/VOLTAJE

⚡ kW kcal/h
⚡ kw V~ Hz

PREZZO/PRICE
PREIS/PRIX/PRECIO
KG / M³



KIT-TOPM-SA KIT TAMPONAMENTI LATERALI PER SCHIENA POSTERIORE MONTATA SU APPARECCHI TOP E MOBILI "M-.."

08600001

EN Side KIT for back cover mounted on the TOP machine and Stand "M-.."
• DE Seitliches KIT für Rückenwand montiert auf der TOP-Maschine und Unterbau "M-.."
• FR KIT latéral pour Dos de finition monté sur la machine TOP et Placard "M-.."
• ES KIT lateral para panel posteriore montado en la máquina TOP y Mueble base "M-.."

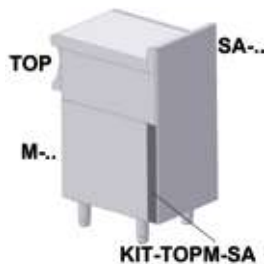

92,00
1 / 0,01

TPC-9 TESTATA CHIUSURA PER CF-PC-TP (SOLO GAS) (IN DOTAZIONE 1 PEZZO PER APPARECCHIO)

09560002

EN Head end filler strip for CF-PC-TP (Gas only) (1 piece included in each machine)
• DE Abschluss-Element für CF-PC-TP (nur gas) (1 Stück in jeder Maschine enthalten)
• FR Élément de jonction pour CF-PC-TP (seulement gaz) (1 pièce incluse dans chaque machine)
• ES Chapa de cierre para CF-PC-TP (solo gas) (1 pieza incluida en cada equipo)
cm. 0,2x 70,5



71,00
1 / 0,00

TPA-9 TESTATA CHIUSURA PER TUTTI GLI ALTRI MODELLI (IN DOTAZIONE 1 PEZZO PER APPARECCHIO)

09560001

EN Head end filler strip for all other models (1 piece included in each machine)
• DE Abschluss-Element für alle anderen Modelle (1 Stück in jeder Maschine enthalten)
• FR Élément de jonction pour tous les autres modèles (1 pièce incluse dans chaque machine)
• ES Chapa de cierre para todos los demás modelos (1 pieza incluida en cada equipo)
cm. 0,2x 70,5



71,00
1 / 0,00

TMA-9SX TESTATA 1 LATO SERIE 90 SINISTRA

09540901

EN Head 1 side S90 left
• DE Abschluss element 1 seite S90 links
• FR Element de jonction 1 coté S90 gauche
• ES Embellecedor 1 lado S90 izquierda
cm. 0,2x 90



273,00
10 / 0,05

TMA-9DX TESTATA 1 LATO SERIE 90 DESTRA

09540900

EN Head 1 side S90 right
• DE Abschluss element 1 seite S90 recht
• FR Element de jonction 1 coté S90 droit
• ES Embellecedor 1 lado S90 derecha
cm. 0,2x 90



273,00
10 / 0,05

TMA-99 TESTATA 2 LATI SERIE 90

09549900

EN Head 2 sides S90
• DE Abschluss element seiten S90
• FR Element de jonction 2 cotés S90
• ES Embellecedor 2 lados S90
cm. 0,2x180



545,00
20 / 0,10

ACCESSORI

MOD.
COD.

DESCRIZIONE/DESCRIPTION/BEZEICHNUNG/DESCRIPTION/DESCRIPCIÓN
DIMENSIONI/DIMENSIONS/ABMESSUNGEN/DIMENSIONS/DIMENSIONES

POTENZA/POWER/LEISTUNG/PUISSANCE/POTENCIA
VOLTAGGIO/VOLTAGE/SPANNUNG/VOLTAGE/VOLTAJE

⚡ kW
kcal/h

⚡ kW
V~
Hz

PREZZO/PRICE
PREIS/PRIX/PRECIO
KG / M³



TMTA-9SX
09540921

TESTATA TAMBURATA 1 LATO SERIE 90 SINISTRA, CON STESSO PROFILO LINEA FRONTALE

EN Head 1 side S90 left, with the same front line profile • **DE** Abschluss element 1 seite S90 links, mit dem gleichen Frontlinienprofil • **FR** Element de jonction 1 coté S90 gauche, avec le même profil de ligne • **ES** Embellecedor 1 lado S90 izquierda, con el mismo perfil de línea frontal
cm. 7,5x 90



852,00
16 / 0,20

TMTA-9DX
09540920

TESTATA TAMBURATA 1 LATO SERIE 90 DESTRA, CON STESSO PROFILO LINEA FRONTALE

EN Head 1 side S90 right, with the same front line profile • **DE** Abschluss element 1 seite S90 recht, mit dem gleichen Frontlinienprofil • **FR** Element de jonction 1 coté S90 droit, avec le même profil de ligne • **ES** Embellecedor 1 lado S90 derecha, con el mismo perfil de línea frontal
cm. 7,5x 90



852,00
16 / 0,20

TMTA-99
09549920

TESTATA TAMBURATA 2 LATI SERIE 90, CON STESSO PROFILO LINEA FRONTALE

EN Head 2 sides S90, with the same front line profile • **DE** Abschluss element seiten S90, mit dem gleichen Frontlinienprofil • **FR** Element de jonction 2 cotés S90, avec le même profil de ligne • **ES** Embellecedor 2 lados S90, con el mismo perfil de línea frontal
cm. 7,5x 180



1.629,00
32 / 0,38

SIA-7/9
08480000

STAFFA INFERIORE UNIONE APPARECCHI

EN Lower bracket to join two items

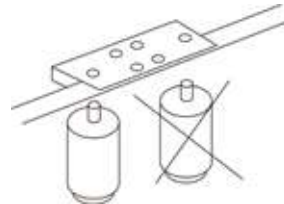

59,00
2 / 0,00

ACCESSORI

MOD. _____
COD. _____

DESCRIZIONE/DESCRIPTION/BEZEICHNUNG/DESCRIPTION/DESCRIPCIÓN
DIMENSIONI/DIMENSIONS/ABMESSUNGEN/DIMENSIONS/DIMENSIONES

POTENZA/POWER/LEISTUNG/PUISSANCE/POTENCIA
VOLTAGGIO/VOLTAGE/SPANNUNG/VOLTAGE/VOLTAJE

$\frac{kW}{kcal/h}$ $\frac{V}{Hz}$

PREZZO/PRICE
PREIS/PRIX/PRECIO
KG / M³



SR-100
50900001

SET 4 RUOTE Ø 100X30, 2 CON FRENO
EN Set of 4 wheels Ø 100x30, 2 with brake • **DE** 4 Rollen Satz Ø 100x30, 2 davon mit Feststellbremse • **FR** Kit 4 roues Ø 100x30, 2 avec frein • **ES** Equipo 4 ruedas Ø 100x30, 2 con frenos
cm. 12,7h

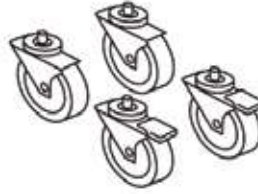

355,00
1 / 0,01

08570103

MENSOLA ANTERIORE
EN Earlier shelf • **DE** Frühere Regal • **FR** Plus tôt plateau • **ES** A principios de la plataforma
cm. 30x 21x 5h



406,00
/ 0,01

08570104

cm. 40x 21x 5h

418,00
/ 0,01

08570105

cm. 50x 21x 5h

430,00
/ 0,01

08570106

cm. 60x 21x 5h

442,00
/ 0,01

08570107

cm. 70x 21x 5h

452,00
/ 0,01

08570108

cm. 80x 21x 5h

463,00
/ 0,01

08570109

cm. 90x 21x 5h

476,00
/ 0,02

08570110

cm. 100x 21x 5h

487,00
/ 0,02

08570111

cm. 110x 21x 5h

501,00
/ 0,02

08570112

cm. 120x 21x 5h

514,00
/ 0,02

08570113

cm. 130x 21x 5h

531,00
/ 0,02

08570114

cm. 140x 21x 5h

543,00
/ 0,02

08570115

cm. 150x 21x 5h

560,00
/ 0,02

08570116

cm. 160x 21x 5h

576,00
/ 0,03

ACCESSORI

MOD. _____
COD. _____

DESCRIZIONE/DESCRIPTION/BEZEICHNUNG/DESCRIPTION/DESCRIPCIÓN
DIMENSIONI/DIMENSIONS/ABMESSUNGEN/DIMENSIONS/DIMENSIONES

POTENZA/POWER/LEISTUNG/PUISSANCE/POTENCIA
VOLTAGGIO/VOLTAGE/SPANNUNG/VOLTAGE/VOLTAJE

⚡ kW kcal/h
⚡ kw V~ Hz

PREZZO/PRICE
PREIS/PRIX/PRECIO
KG / M³



MOD. / COD.	DESCRIZIONE/DESCRIPTION/BEZEICHNUNG/DESCRIPTION/DESCRIPCIÓN DIMENSIONI/DIMENSIONS/ABMESSUNGEN/DIMENSIONS/DIMENSIONES	POTENZA/POWER/LEISTUNG/PUISSANCE/POTENCIA VOLTAGGIO/VOLTAGE/SPANNUNG/VOLTAGE/VOLTAJE	⚡ kW kcal/h ⚡ kw V~ Hz	PREZZO/PRICE PREIS/PRIX/PRECIO KG / M ³
08570002	CORRIMANO EN Handrail • DE Hand Lauf • FR Main courante • ES Pasamano cm. 20x 7x 4h			341,00 / 0,00
08570003	cm. 30x 7x 4h			346,00 / 0,00
08570004	cm. 40x 7x 4h			350,00 / 0,00
08570005	cm. 50x 7x 4h			359,00 / 0,00
08570006	cm. 60x 7x 4h			371,00 / 0,00
08570007	cm. 70x 7x 4h			377,00 / 0,00
08570008	cm. 80x 7x 4h			383,00 / 0,01
08570009	cm. 90x 7x 4h			389,00 / 0,01
08570010	cm. 100x 7x 4h			395,00 / 0,01
08570011	cm. 110x 7x 4h			406,00 / 0,01
08570012	cm. 120x 7x 4h			418,00 / 0,01
08570013	cm. 130x 7x 4h			431,00 / 0,01
08570014	cm. 140x 7x 4h			446,00 / 0,01
08570015	cm. 150x 7x 4h			486,00 / 0,01
08570016	cm. 160x 7x 4h			526,00 / 0,01



533116300	GIUNZIONE CORRIMANO EN junction handrail • DE Gelenk Hand lauf • FR Main courante de l'embranchement • ES conexión pasamano cm. Ø 3x 2,4			54,00 / 1,00
-----------	---	--	--	------------------------

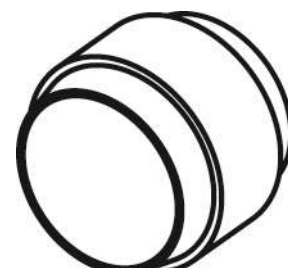

ZB 01410000	ZOCCOLATURA BASE EN FRONT PLINTH • DE GRUNDSOCKEL • FR PLINTHE FRONTAL • ES ZOCOLOS BASE €/m x cm. 15h			143,00 /
----------------	--	--	--	--------------------



ACCESSORI

MOD. _____
COD. _____

DESCRIZIONE/DESCRIPTION/BEZEICHNUNG/DESCRIPTION/DESCRIPCIÓN
DIMENSIONI/DIMENSIONS/ABMESSUNGEN/DIMENSIONS/DIMENSIONES

POTENZA/POWER/LEISTUNG/PUISSANCE/POTENCIA
VOLTAGGIO/VOLTAGE/SPANNUNG/VOLTAGE/VOLTAJE

⚡ kW kcal/h
⚡ kw V~ Hz

PREZZO/PRICE
PREIS/PRIX/PRECIO
KG / M³

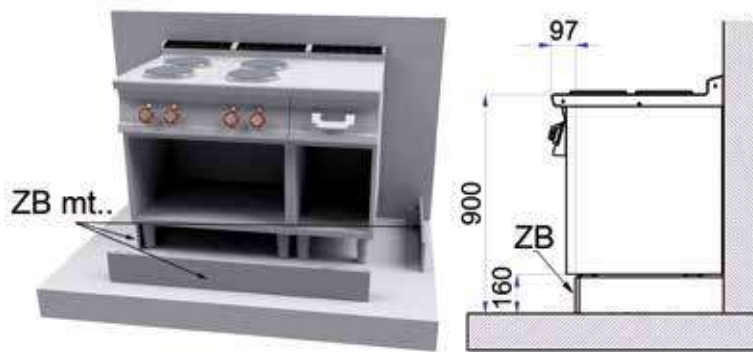

FZ-9
09480001

ZOCOLATURA LATERALE - KIT

EN side plinth - kit • **DE** seitensockel - kit • **FR** plinthe lateral - kit
• **ES** zocolos lateral - kit
cm. 1,5x 80x 6h

300,00
/



CZ-72/92
08480002

KIT CASSETTO ZOCCOLO, INCLUSI 4 PIEDINI

EN drawer clog - kit (4 small feet included) • **DE** schubladen sockel - kit (4 kleine FüÙe enthalten) • **FR** tiroir plinthe - kit (4 petits pieds inclus)
• **ES** cajon zocolos - kit (4 pies pequeno incluido)
cm. 20x 61x 5,5h

172,00
3 / 0,01



CZ-93
09480003

cm. 30x 81x 5,5h

235,00
4 / 0,02

CZ-94
09480004

cm. 40x 81x 5,5h

266,00
4.5 / 0,03

CZ-96
09480006

cm. 60x 81x 5,5h

330,00
5.5 / 0,04

CZ-98
09480008

cm. 80x 81x 5,5h

407,00
7.5 / 0,06

CZ-912
09480012

cm. 120x 81x 5,5h

558,00
8.5 / 0,08

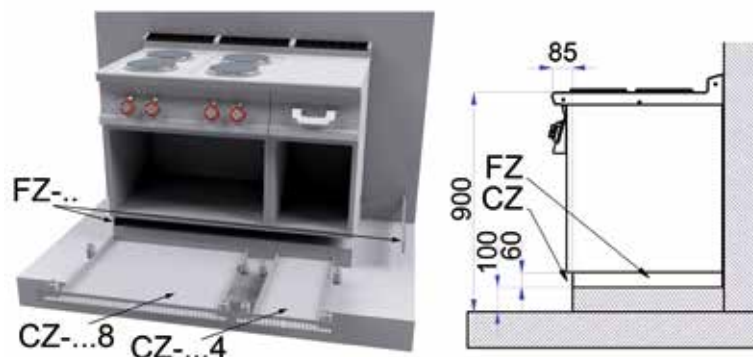

PIANI LAVORO - TOP

MOD. _____
COD. _____

DESCRIZIONE/DESCRIPTION/BEZEICHNUNG/DESCRIPTION/DESCRIPCIÓN
DIMENSIONI/DIMENSIONS/ABMESSUNGEN/DIMENSIONS/DIMENSIONES

POTENZA/POWER/LEISTUNG/PUISSANCE/POTENCIA
VOLTAGGIO/VOLTAGE/SPANNUNG/VOLTAGE/VOLTAJE

⚡ kW kcal/h
⚡ kw V~ Hz

PREZZO/PRICE
PREIS/PRIX/PRECIO
KG / M³



PLT-92
19010200

PIANO LAVORO (INCLUSA 1 TESTATA CHIUSURA PIANO MOD.TPA-9)

EN Worktop (included 1 Head end filler strip mod.TPA-9) • **DE** Arbeitsplatte (inbegriffen 1 Abschluss-Element mod.TPA-9) • **FR** Plan de travail (inclus 1 Élément de jonction top mod.TPA-9) • **ES** Sobre de trabajo (incluida 1 Chapa de cierre para top mod.TPA-9)
cm. 20x 90x 28h



687,00
18 / 0,23

PLST-93
19010301

cm. 30x 90x 28h



713,00
22 / 0,23

PLST-94
19010401

cm. 40x 90x 28h



728,00
23 / 0,23

PLST-96
19010601

cm. 60x 90x 28h



1.171,00
29 / 0,33

PLST-98
19010801

cm. 80x 90x 28h



1.302,00
35 / 0,44

PLT-93
19010300

PIANO LAVORO CASSETTO 19X50X15H INOX (INCLUSA 1 TESTATA CHIUSURA PIANO MOD.TPA-9)

EN Worktop - Drawer cm. 19x50x15h (included 1 Head end filler strip mod.TPA-9) • **DE** Arbeitsplatte - Schublade cm. 19x50x15h (inbegriffen 1 Abschluss-Element mod.TPA-9) • **FR** Plan de travail - Tiroir inox cm. 19x50x15h (inclus 1 Élément de jonction top mod.TPA-9) • **ES** Sobre de trabajo. Cajón cm. 19x50x15h inox (incluida 1 Chapa de cierre para top mod.TPA-9)
cm. 30x 90x 28h



1.011,00
25 / 0,23

PLT-94
19010400

PIANO LAVORO CASSETTO CON 1 BACINELLA GN 1/1 15H PLASTICA (INCLUSA 1 TESTATA CHIUSURA PIANO MOD. TPA-9)

EN Worktop - Drawer with 1 plastic container GN 1/1 15h (included 1 Head end filler strip mod.TPA-9) • **DE** Arbeitsplatte - Schublade mit 1 GN 1/1 15h Kunststoffbehälter (inbegriffen 1 Abschluss-Element mod.TPA-9) • **FR** Plan de travail - Tiroir avec bac en plastique GN 1/1 15h (inclus 1 Élément de jonction top mod.TPA-9) • **ES** Sobre de trabajo Cajón con 1 contenedor GN 1/1 15h plástico (incluida 1 Chapa de cierre para top mod.TPA-9)
cm. 40x 90x 28h



970,00
28 / 0,23

PIANI LAVORO - TOP

MOD. _____
COD. _____

DESCRIZIONE/DESCRIPTION/BEZEICHNUNG/DESCRIPTION/DESCRIPCIÓN
DIMENSIONI/DIMENSIONS/ABMESSUNGEN/DIMENSIONS/DIMENSIONES

POTENZA/POWER/LEISTUNG/PUISSANCE/POTENCIA
VOLTAGGIO/VOLTAGE/SPANNUNG/VOLTAGE/VOLTAJE

⚡ kW _____
kcal/h _____
V~ _____
Hz _____

PREZZO/PRICE _____
PREIS/PRIX/PRECIO _____
KG / M³ _____



PLT-96
19010600

PIANO LAVORO CASSETTO 49X50X15H INOX (INCLUSA 1 TESTATA CHIUSURA PIANO MOD.TPA-9)

EN Worktop - Drawer cm. 49x50x15h (included 1 Head end filler strip mod.TPA-9) • **DE** Arbeitsplatte - Schublade cm. 49x50x15h (inbegriffen 1 Abschluss-Element mod.TPA-9) • **FR** Plan de travail - tiroir inox cm. 49x50x15h (inclus 1 Élément de jonction top mod.TPA-9) • **ES** Sobre de trabajo. Cajón cm. 49x50x15h inox (incluida 1 Chapa de cierre para top mod.TPA-9)
cm. 60x 90x 28h



1.443,00
38 / 0,33

PLT-98
19010800

PIANO LAVORO CASSETTO CON 2 BACINELLE GN 1/1 15H PLASTICA (INCLUSA 1 TESTATA CHIUSURA PIANO MOD.TPA-9)

EN Worktop - Drawer with 2 plastic containers GN 1/1 15h (included 1 Head end filler strip mod.TPA-9) • **DE** Arbeitsplatte - Schublade mit 2 GN 1/1 15h Kunststoffbehältern (inbegriffen 1 Abschluss-Element mod.TPA-9) • **FR** Plan de travail - tiroir avec 2 bacs en plastique GN 1/1 15h (inclus 1 Élément de jonction top mod.TPA-9) • **ES** Sobre de trabajo Cajón con 2 contenedores GN 1/1 15h plástico (incluida 1 Chapa de cierre para top mod.TPA-9)
cm. 80x 90x 28h



1.601,00
46 / 0,44

LAT-94
19020400

LAVELLO RUBINETTO A LEVA - VASCA CM. 30X35X15H (INCLUSA 1 TESTATA CHIUSURA PIANO MOD.TPA-9)

EN Sink unit - Lever type tap - Bowl cm. 30x35x15h (included 1 Head end filler strip mod.TPA-9) • **DE** Spülbecken - Einhebel-Mischbatterie Becken cm. 30x35x15h (inbegriffen 1 Abschluss-Element mod.TPA-9) • **FR** Bac-évier avec robinetterie - Bac cm 30x35x15h (inclus 1 Élément de jonction top mod.TPA-9) • **ES** Fregadero - Grifo a palanca - Pileta cm. 30x35x15h (incluida 1 Chapa de cierre para top mod.TPA-9)
cm. 40x 90x 28h



1.219,00
24 / 0,23

PCT-94ET
19030430

PIANO COTTURA TRIFASE N. 2 PIASTRE (INCLUSA 1 TESTATA CHIUSURA PIANO MOD.TPA-9)

EN Boiling unit threephase - N. 2 plates (included 1 Head end filler strip mod.TPA-9) • **DE** Kochplatte dreiphasig - N. 2 Kochplatten (inbegriffen 1 Abschluss-Element mod.TPA-9) • **FR** Rechaud électriques - N. 2 plaques (inclus 1 Élément de jonction top mod.TPA-9) • **ES** Sobre de cocción trifásico - N. 2 planchas (incluida 1 Chapa de cierre para top mod.TPA-9)
cm. 40x 90x 28h



⚡ 7 kW _____
400V~2N _____
230V~3 _____
230V~ _____
50/60 Hz _____

1.416,00
29 / 0,23

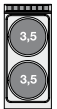

PCT-98ET
19030830

PIANO COTTURA TRIFASE N. 4 PIASTRE (INCLUSA 1 TESTATA CHIUSURA PIANO MOD.TPA-9)

EN Boiling unit threephase - N. 4 plates (included 1 Head end filler strip mod.TPA-9) • **DE** Kochplatte dreiphasig - N. 4 Kochplatten (inbegriffen 1 Abschluss-Element mod.TPA-9) • **FR** Rechaud électriques - N. 4 plaques (inclus 1 Élément de jonction top mod.TPA-9) • **ES** Sobre de cocción trifásico - N. 4 planchas (incluida 1 Chapa de cierre para top mod.TPA-9)
cm. 80x 90x 28h



⚡ 14 kW _____
400V~3N _____
50/60 Hz _____

2.850,00
68 / 0,44

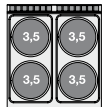

PCT-912ET
19031230

PIANO COTTURA TRIFASE N. 6 PIASTRE (INCLUSA 1 TESTATA CHIUSURA PIANO MOD.TPA-9)

EN Boiling unit threephase - N. 6 plates (included 1 Head end filler strip mod.TPA-9) • **DE** Kochplatte dreiphasig - N. 6 Kochplatten (inbegriffen 1 Abschluss-Element mod.TPA-9) • **FR** Rechaud électriques - N. 6 plaques (inclus 1 Élément de jonction top mod.TPA-9) • **ES** Sobre de cocción trifásico - N. 6 planchas (incluida 1 Chapa de cierre para top mod.TPA-9)
cm. 120x 90x 28h



⚡ 21 kW _____
400V~3N _____
50/60 Hz _____

3.907,00
94 / 0,64

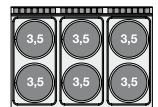

PIANI COTTURA ELETTRICI - TOP

MOD. _____
COD. _____

DESCRIZIONE/DESCRIPTION/BEZEICHNUNG/DESCRIPTION/DESCRIPCIÓN
DIMENSIONI/DIMENSIONS/ABMESSUNGEN/DIMENSIONS/DIMENSIONES

POTENZA/POWER/LEISTUNG/PUISSANCE/POTENCIA
VOLTAGGIO/VOLTAGE/SPANNUNG/VOLTAGE/VOLTAJE

⚡ kW _____
kcal/h _____
V~ _____
Hz _____

PREZZO/PRICE
PREIS/PRIX/PRECIO
KG / M³



PCQT-94ET PIANO COTTURA TRIFASE - N. 2 PIASTRE QUADRE (INCLUSA
19030431 1 TESTATA CHIUSURA PIANO MOD.TPA-9)

EN Boiling unit threephase - N. 2 square plates (included 1 Head end filler strip mod.TPA-9) • **DE** Kochplatte dreiphasig - N. 2 quadratischen Platten (inbegriffen 1 Abschluss-Element mod.TPA-9) • **FR** Rechaud électriques - N. 2 plaques carrés (inclus 1 Élément de jonction top mod. TPA-9) • **ES** Sobre de cocción trifásico - N. 2 planchas cuadradas (incluida 1 Chapa de cierre para top mod.TPA-9)
cm. 40x 90x 28h



⚡ 8 kW _____ **1.967,00**
400V~2N _____ 33 / 0,23
230V~3
230V~
50/60 Hz



PCQT-98ET PIANO COTTURA TRIFASE - N. 4 PIASTRE QUADRE (INCLUSA
19030831 1 TESTATA CHIUSURA PIANO MOD.TPA-9)

EN Boiling unit threephase - N. 4 square plates (included 1 Head end filler strip mod.TPA-9) • **DE** Kochplatte dreiphasig - N. 4 quadratischen Platten (inbegriffen 1 Abschluss-Element mod.TPA-9) • **FR** Rechaud électriques - N. 4 plaques carrés (inclus 1 Élément de jonction top mod. TPA-9) • **ES** Sobre de cocción trifásico - N. 4 planchas cuadradas (incluida 1 Chapa de cierre para top mod.TPA-9)
cm. 80x 90x 28h



⚡ 16 kW _____ **3.632,00**
400V~3N _____ 71 / 0,44
50/60 Hz



PCQT-912ET PIANO COTTURA TRIFASE - N. 6 PIASTRE QUADRE (INCLUSA
19031231 1 TESTATA CHIUSURA PIANO MOD.TPA-9)

EN Boiling unit threephase - N. 6 square plates (included 1 Head end filler strip mod.TPA-9) • **DE** Kochplatte dreiphasig - N. 6 quadratischen Platten (inbegriffen 1 Abschluss-Element mod.TPA-9) • **FR** Rechaud électriques - N. 6 plaques carrés (inclus 1 Élément de jonction top mod. TPA-9) • **ES** Sobre de cocción trifásico - N. 6 planchas cuadradas (incluida 1 Chapa de cierre para top mod.TPA-9)
cm. 120x 90x 28h



⚡ 24 kW _____ **5.703,00**
400V~3N _____ 112 / 0,64
50/60 Hz



PCCT-94ET PIANO COTTURA VETROCERAMICA TRIFASE - N. 2 ZONE -
19030432 VETRO CM.35X77 (INCLUSA 1 TESTATA CHIUSURA PIANO MOD.TPA-9)

EN Ceramic glass boiling unit - n. 2 zones - glass cm.35x77 (included 1 Head end filler strip mod.TPA-9) • **DE** Ceran-Kochplatte dreiphasig - 2 zonen - Glas 35x77 cm (inbegriffen 1 Abschluss-Element mod.TPA-9) • **FR** Plan de cuisson à vitroceramique triphasé N. 2 zones - Verre cm.35x77 (inclus 1 Élément de jonction top mod.TPA-9) • **ES** Sobre de cocción trifásico vitrocerámica - 2 zonas - vidrio cm.35x77 (incluida 1 Chapa de cierre para top mod.TPA-9)
cm. 40x 90x 28h



⚡ 6,8 kW _____ **2.439,00**
400V~2N _____ 38 / 0,23
230V~3
230V~
50/60 Hz

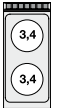

PCCT-98ET PIANO COTTURA VETROCERAMICA TRIFASE - N. 4 ZONE -
19030832 VETRO CM.75X77 (INCLUSA 1 TESTATA CHIUSURA PIANO MOD.TPA-9)

EN Ceramic glass boiling unit - n. 4 zones - glass cm.75x77 (included 1 Head end filler strip mod.TPA-9) • **DE** Ceran-Kochplatte dreiphasig - 4 zonen - Glas 75x77 cm (inbegriffen 1 Abschluss-Element mod.TPA-9) • **FR** Plan de cuisson à vitroceramique triphasé N. 4 zones - Verre cm.75x77 (inclus 1 Élément de jonction top mod.TPA-9) • **ES** Sobre de cocción trifásico vitrocerámica - 4 zonas - vidrio cm.75x77 (incluida 1 Chapa de cierre para top mod.TPA-9)
cm. 80x 90x 28h



⚡ 13,6 kW _____ **4.272,00**
400V~3N _____ 70 / 0,44
230V~3
50/60 Hz

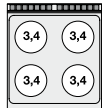

PCIT-94ET PIANO COTTURA INDUZIONE TRIFASE - N. 2 ZONE - VETRO
19030433 CM.35X77 (NON POSIZIONARE SU FORNI O CASSETTIERE) (INCLUSA 1 TESTATA CHIUSURA PIANO MOD.TPA-9)

EN Three-phase induction cooking - 2 zones - glass cm.35x77 (do not place on ovens or drawers) (included 1 Head end filler strip mod.TPA-9) • **DE** Induktions-Kochplatte dreiphasig - 2 zonen - Glas 35x77 cm (nicht Platz auf Öfen oder Schubladen) (inbegriffen 1 Abschluss-Element mod. TPA-9) • **FR** Plan de cuisson à induction triphasé N. 2 zones - Verre cm.35x77 (ne placez pas sur des fours ou des tiroirs) (inclus 1 Élément de jonction top mod.TPA-9) • **ES** Encimera inducción trifásica - 2 zonas - Vidrio cm.35x77 (No coloque en los hornos o en los cajones) (incluida 1 Chapa de cierre para top mod.TPA-9)
cm. 40x 90x 28h



⚡ 10 kW _____ **8.135,00**
400V~3 _____ 38 / 0,23
50/60 Hz

PIANI COTTURA A INDUZIONE - TOP

MOD. _____
COD. _____

DESCRIZIONE/DESCRIPTION/BEZEICHNUNG/DESCRIPTION/DESCRIPCIÓN
DIMENSIONI/DIMENSIONS/ABMESSUNGEN/DIMENSIONS/DIMENSIONES

POTENZA/POWER/LEISTUNG/PUISSANCE/POTENCIA
VOLTAGGIO/VOLTAGE/SPANNUNG/VOLTAGE/VOLTAJE

⚡ kW _____
kcal/h _____
V~ _____
Hz _____

PREZZO/PRICE
PREIS/PRIX/PRECIO
KG / M³



PCIWT-94ET PIANO COTTURA INDUZIONE TRIFASE "WOK" - N. 1
19030434 ZONA - VETRO Ø 30 CM. (NON POSIZIONARE SU FORNI O
CASSETTIERE) (INCLUSA 1 TESTATA CHIUSURA PIANO MOD.
TPA-9)

EN Three-phase induction cooking "WOK" - 1 zone - glass Ø 30 cm (do not place on ovens or drawers) (included 1 Head end filler strip mod. TPA-9) • **DE** Induktions-Kochplatte "WOK" dreiphasig - 1 zonen - Glas Ø 30 cm (nicht Platz auf Öfen oder Schubladen) (inbegriffen 1 Abschluss-Element mod.TPA-9) • **FR** Plan de cuisson à induction "WOK" triphasé N. 1 zone - Verre cm Ø 30 (ne placez pas sur des fours ou des tiroirs) (inclus 1 Élément de jonction top mod.TPA-9) • **ES** Encimera inducción "WOK" trifásica - 1 zona - Vidrio Ø 30 cm (No coloque en los hornos o en los cajones) (incluida 1 Chapa de cierre para top mod.TPA-9)
cm. 40x 90x 28h



⚡ 5 kW _____ **5.950,00**
400V~3 _____ 34 / 0,23
50/60 Hz

PCIT-98ET PIANO COTTURA INDUZIONE TRIFASE - N. 4 ZONE - VETRO
19030833 **CM.75X77 (NON POSIZIONARE SU FORNI O CASSETTIERE)**
(INCLUSA 1 TESTATA CHIUSURA PIANO MOD.TPA-9)

EN Three-phase induction cooking - 4 zones - glass cm.75x77 (do not place on ovens or drawers) (included 1 Head end filler strip mod.TPA-9) • **DE** Induktions-Kochplatte dreiphasig - 4 zonen - Glas 75x77 cm (nicht Platz auf Öfen oder Schubladen) (inbegriffen 1 Abschluss-Element mod. TPA-9) • **FR** Plan de cuisson à induction triphasé N. 4 zones - Verre cm.75x77 (ne placez pas sur des fours ou des tiroirs) (inclus 1 Élément de jonction top mod.TPA-9) • **ES** Encimera inducción trifásica - 4 zonas - Vidrio cm.75x77 (No coloque en los hornos o en los cajones) (incluida 1 Chapa de cierre para top mod.TPA-9)
cm. 80x 90x 28h



⚡ 20 kW _____ **15.618,00**
400V~3 _____ 76 / 0,44
50/60 Hz

PIANI COTTURA A INDUZIONE - TOP

MOD. _____
COD. _____

DESCRIZIONE/DESCRIPTION/BEZEICHNUNG/DESCRIPTION/DESCRIPCIÓN
DIMENSIONI/DIMENSIONS/ABMESSUNGEN/DIMENSIONS/DIMENSIONES

POTENZA/POWER/LEISTUNG/PUISSANCE/POTENCIA
VOLTAGGIO/VOLTAGE/SPANNUNG/VOLTAGE/VOLTAJE

⚡ kW
kcal/h

⚡ kW
V~
Hz

PREZZO/PRICE
PREIS/PRIX/PRECIO
KG / M³



PCT-94G
19210450

PIANO COTTURA GAS 2 FUOCHI (INCLUSA 1 TESTATA CHIUSURA PIANO MOD.TPC-9)

EN Gas heated boiling - 2 burners (included 1 Head end filler strip mod.TPC-9) • **DE** Gas-Kochplatte - 2 Kochstellen (inbegriffen 1 Abschluss-Element mod.TPC-9) • **FR** Rechaud gaz - 2 feux vifs (inclus 1 Élément de jonction top mod.TPC-9) • **ES** Sobres de cocción gas - 2 quemadores (incluida 1 Chapa de cierre para top mod.TPC-9)
cm. 40x 90x 28h



⚡ 11 kW
9.460 kcal/h

1.748,00
64 / 0,23



PCT-98G
19210850

PIANO COTTURA GAS 4 FUOCHI (INCLUSA 1 TESTATA CHIUSURA PIANO MOD.TPC-9)

EN Gas heated boiling unit - 4 burners (included 1 Head end filler strip mod.TPC-9) • **DE** Gas-Kochplatte - 4 Kochstellen (inbegriffen 1 Abschluss-Element mod.TPC-9) • **FR** Rechaud gaz - 4 feux vifs (inclus 1 Élément de jonction top mod.TPC-9) • **ES** Sobres de cocción gas - 4 quemadores (incluida 1 Chapa de cierre para top mod.TPC-9)
cm. 80x 90x 28h



⚡ 28 kW
24.080 kcal/h

3.062,00
80 / 0,44

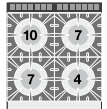

PCT-912G
19211250

PIANO COTTURA GAS 6 FUOCHI (INCLUSA 1 TESTATA CHIUSURA PIANO MOD.TPC-9)

EN Gas heated boiling unit - 6 burners (included 1 Head end filler strip mod.TPC-9) • **DE** Gas-Kochplatte - 6 Kochstellen (inbegriffen 1 Abschluss-Element mod.TPC-9) • **FR** Rechaud gaz - 6 feux vifs (inclus 1 Élément de jonction top mod.TPC-9) • **ES** Sobres de cocción gas - 6 quemadores (incluida 1 Chapa de cierre para top mod.TPC-9)
cm. 120x 90x 28h



⚡ 45 kW
38.700 kcal/h

4.314,00
131 / 0,64

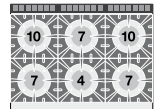

PAT-98G
19210851

"PAELLERO" GAS (INCLUSA 1 TESTATA CHIUSURA PIANO MOD.TPC-9)

EN "PAELLERO" Gas (included 1 Head end filler strip mod.TPC-9) • **DE** "PAELLERO" Gas (inbegriffen 1 Abschluss-Element mod.TPC-9) • **FR** "PAELLERO" gaz (inclus 1 Élément de jonction top mod.TPC-9) • **ES** "PAELLERO" gas (incluida 1 Chapa de cierre para top mod.TPC-9)
cm. 80x 90x 28h



⚡ 26,7 kW
22.962 kcal/h

4.452,00
139 / 0,44

TPT-94G
19290450

TUTTA PIASTRA PIASTRA CM 39X73 (INCLUSA 1 TESTATA CHIUSURA PIANO MOD.TPC-9)

EN Solid top - Plate 39x73 cm (included 1 Head end filler strip mod.TPC-9) • **DE** Kochplatte - Platte 39x73 cm (inbegriffen 1 Abschluss-Element mod.TPC-9) • **FR** Toute plaque - Plaque cm 39x73 (inclus 1 Élément de jonction top mod.TPC-9) • **ES** Placa de cocción - Placa cm 39x73 (incluida 1 Chapa de cierre para top mod.TPC-9)
cm. 40x 90x 28h



⚡ 7 kW
6.020 kcal/h

2.188,00
64 / 0,23

TUTTAPIASTRA A GAS - TOP

MOD. _____
COD. _____

DESCRIZIONE/DESCRIPTION/BEZEICHNUNG/DESCRIPTION/DESCRIPCIÓN
DIMENSIONI/DIMENSIONS/ABMESSUNGEN/DIMENSIONS/DIMENSIONES

POTENZA/POWER/LEISTUNG/PUISSANCE/POTENCIA
VOLTAGGIO/VOLTAGE/SPANNUNG/VOLTAGE/VOLTAJE

⚡ kW kcal/h
⚡ kw kcal/h
V~ Hz

PREZZO/PRICE
PREIS/PRIX/PRECIO
KG / M³



TPT-98G
19290850

TUTTA PIASTRA PIASTRA CM 79X73 (INCLUSA 1 TESTATA CHIUSURA PIANO MOD.TPC-9)

EN Solid top - Plate 79x73 cm (included 1 Head end filler strip mod.TPC-9) • **DE** Kochplatte - Platte 79x73 cm (inbegriffen 1 Abschluss-Element mod.TPC-9) • **FR** Toute plaque - Plaque cm. 79x73 (inclus 1 Elément de jonction top mod.TPC-9) • **ES** Placa de cocción - Placa cm 79x73 (incluida 1 Chapa de cierre para top mod.TPC-9)
cm. 80x 90x 28h



⚡ 12 kW
10.320 kcal/h **3.211,00**
137 / 0,44

TPT-98ET
19120830

TUTTA PIASTRA PIASTRA CM. 70X68 - 4 ZONE (INCLUSA 1 TESTATA CHIUSURA PIANO MOD.TPA-9)

EN Solid top - Plate cm. 70x68 (included 1 Head end filler strip mod.TPA-9) • **DE** Kochplatten - Platte cm. 70x68 (inbegriffen 1 Abschluss-Element mod.TPA-9) • **FR** Toute plaque - Plaque cm. 70x68 (inclus 1 Elément de jonction top mod.TPA-9) • **ES** Placa de cocción - Placa cm. 70x68 (incluida 1 Chapa de cierre para top mod.TPA-9)
cm. 80x 90x 28h



⚡ 13,6 kW
400V~3N 108 / 0,44
50/60 Hz

TPIT-98ET
19120833

TUTTOPIANO INDUZIONE TRIFASE - VETRO CM.75X77 (NON POSIZIONARE SU FORNI O CASSETTIERE) (INCLUSA 1 TESTATA CHIUSURA PIANO MOD.TPA-9)

EN Three-phase induction Solid top - glass cm.75x77 (do not place on ovens or drawers) (included 1 Head end filler strip mod.TPA-9) • **DE** Induktions-Kochplatte dreiphasig - Glas 75x77 cm (nicht Platz auf Öfen oder Schubladen) (inbegriffen 1 Abschluss-Element mod.TPA-9) • **FR** Toute plaque à induction triphasé - Verre cm.75x77 (ne placez pas sur des fours ou des tiroirs) (inclus 1 Elément de jonction top mod.TPA-9) • **ES** Placa de cocción inducción trifásica - Vidrio cm.75x77 (No coloque en los hornos o en los cajones) (incluida 1 Chapa de cierre para top mod.TPA-9)
cm. 80x 90x 28h



⚡ 28 kW
400V~3 80 / 0,44
50/60 Hz

TP2T-98G
19300850

TUTTA PIASTRA + 2 FUOCHI - PIASTRA CM 39X73 (INCLUSA 1 TESTATA CHIUSURA PIANO MOD.TPC-9)

EN Solid top + 2 burners - Plate 39x73 cm (included 1 Head end filler strip mod.TPC-9) • **DE** Kochplatte + 2 Gaskochstellen - Platte 39x73 cm (inbegriffen 1 Abschluss-Element mod.TPC-9) • **FR** Toute plaque + 2 brûleurs - Plaque cm 39x73 (inclus 1 Elément de jonction top mod.TPC-9) • **ES** Placa de cocción + 2 fuegos - Placa cm 39x73 (incluida 1 Chapa de cierre para top mod.TPC-9)
cm. 80x 90x 28h



⚡ 24 kW
20.640 kcal/h **3.291,00**
130 / 0,44

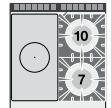

TP2T-912G
19291250

TUTTA PIASTRA + 2 FUOCHI PIASTRA CM. 79X73 (INCLUSA 1 TESTATA CHIUSURA PIANO MOD.TPC-9)

EN Solid top + 2 burners - Plate 79x73 cm (included 1 Head end filler strip mod.TPC-9) • **DE** Kochplatte + 2 Gaskochstellen - Platte 79x73 cm (inbegriffen 1 Abschluss-Element mod.TPC-9) • **FR** Toute plaque + 2 brûleurs - Plaque cm. 79x73 (inclus 1 Elément de jonction top mod.TPC-9) • **ES** Placa de cocción + 2 fuegos - Placa cm. 79x73 (incluida 1 Chapa de cierre para top mod.TPC-9)
cm. 120x 90x 28h



⚡ 29 kW
24.940 kcal/h **4.774,00**
157 / 0,64

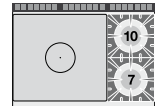

TUTTAPIASTRA A GAS - TOP

MOD. _____
COD. _____

DESCRIZIONE/DESCRIPTION/BEZEICHNUNG/DESCRIPTION/DESCRIPCIÓN
DIMENSIONI/DIMENSIONS/ABMESSUNGEN/DIMENSIONS/DIMENSIONES

POTENZA/POWER/LEISTUNG/PUISSANCE/POTENCIA
VOLTAGGIO/VOLTAGE/SPANNUNG/VOLTAGE/VOLTAJE

⚡ $\frac{\text{kW}}{\text{kcal/h}}$ $\frac{\text{kW}}{\text{V~}}$
Hz

PREZZO/PRICE
PREIS/PRIX/PRECIO
KG / M³



TP4T-912G
19301250

TUTTA PIASTRA + 4 FUOCHI PIASTRA CM. 39X73 (INCLUSA 1 TESTATA CHIUSURA PIANO MOD.TPC-9)
EN Solid top + 4 burners - Plate 39x73 cm (included 1 Head end filler strip mod.TPC-9) • **DE** Kochplatte + 4 Gaskochstellen - Platte 39x73 cm (inbegriffen 1 Abschluss-Element mod.TPC-9) • **FR** Toute plaque + 4 brûleurs - Plaque cm. 39x73 (inclus 1 Élément de jonction top mod.TPC-9) • **ES** Placa de cocción + 4 fuegos - Placa cm. 39x73 (incluida 1 Chapa de cierre para top mod.TPC-9)
cm. 120x 90x 28h



⚡ $\frac{35 \text{ kW}}{30.100 \text{ kcal/h}}$ **4.503,00**
155 / 0,64

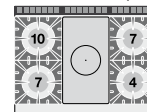

BMT-94EM
19050410

BAGNOMARIA MONOFASE VASCA PER GN 1/1 + GN 1/3 H15 (INCLUSA 1 TESTATA CHIUSURA PIANO MOD.TPA-9)
EN Bain marie singlephase - Bowl for GN 1/1 + GN 1/3 h.15 (included 1 Head end filler strip mod.TPA-9) • **DE** Wasserbäder einphasig - Becken GN 1/1 + GN 1/3 h.15 (inbegriffen 1 Abschluss-Element mod.TPA-9) • **FR** Bain marie monophasé - Cuve GN 1/1 + GN 1/3 h.15 (inclus 1 Élément de jonction top mod.TPA-9) • **ES** Baño de maría monofásico - Cuba para GN 1/1 + GN 1/3 15h (incluida 1 Chapa de cierre para top mod.TPA-9)
cm. 40x 90x 28h



⚡ $\frac{2,85 \text{ kW}}{230\text{V~}}$ **1.779,00**
 $\frac{50/60 \text{ Hz}}{39 / 0,23}$

BMT-98ET
19050830

BAGNOMARIA TRIFASE VASCA PER GN 2/1 + 2 X GN 1/3 H.15 (INCLUSA 1 TESTATA CHIUSURA PIANO MOD.TPA-9)
EN Bain marie threephase - Bowl for GN 2/1 + 2 x GN 1/3 h.15 (included 1 Head end filler strip mod.TPA-9) • **DE** Wasserbäder dreiphasig - Becken GN 2/1 + 2 x GN 1/3 h.15 (inbegriffen 1 Abschluss-Element mod.TPA-9) • **FR** Bain marie triphase - Cuve GN 2/1 + 2 x GN 1/3 h.15 (inclus 1 Élément de jonction top mod.TPA-9) • **ES** Baño de maría trifásico - Cuba para GN 2/1 + 2 x GN 1/3 h.15 (incluida 1 Chapa de cierre para top mod.TPA-9)
cm. 80x 90x 28h



⚡ $\frac{5,7 \text{ kW}}{400\text{V~}3\text{N}}$ **2.542,00**
 $\frac{230\text{V~}3}{50/60 \text{ Hz}}$ 54 / 0,44

BMT-94G
19220450

BAGNOMARIA GAS VASCA PER GN 1/1 + GN 1/3 H.15 (INCLUSA 1 TESTATA CHIUSURA PIANO MOD.TPA-9)
EN Gas bain-marie - Bowl for GN 1/1 + GN 1/3 h.15 (included 1 Head end filler strip mod.TPA-9) • **DE** Gas Wasserbad - Becken GN 1/1 + GN 1/3 h.15 (inbegriffen 1 Abschluss-Element mod.TPA-9) • **FR** Bain-marie gaz - Cuve pour GN 1/1 + GN 1/3 h.15 (inclus 1 Élément de jonction top mod.TPA-9) • **ES** Baño de maría gas - Cuba para GN 1/1 + GN 1/3 15h (incluida 1 Chapa de cierre para top mod.TPA-9)
cm. 40x 90x 28h



⚡ $\frac{3,5 \text{ kW}}{3.010 \text{ kcal/h}}$ **1.968,00**
48 / 0,23

BMT-98G
19220850

BAGNOMARIA GAS VASCA PER GN 2/1 + 2 X GN 1/3 H.15 (INCLUSA 1 TESTATA CHIUSURA PIANO MOD.TPA-9)
EN Gas bain-marie - Bowl for GN 2/1 + 2 x GN 1/3 h.15 (included 1 Head end filler strip mod.TPA-9) • **DE** Gas Wasserbad - Becken GN 2/1 + 2 x GN 1/3 h.15 (inbegriffen 1 Abschluss-Element mod.TPA-9) • **FR** Bain-marie gaz - Cuve pour GN 2/1 + 2 x GN 1/3 h.15 (inclus 1 Élément de jonction top mod.TPA-9) • **ES** Baño de maría gas - Cuba para GN 2/1 + 2 x GN 1/3 15h (incluida 1 Chapa de cierre para top mod.TPA-9)
cm. 80x 90x 28h



⚡ $\frac{6,5 \text{ kW}}{5.590 \text{ kcal/h}}$ **2.886,00**
61 / 0,44

BST-94EM
19040410

CONTENITORE CALDO CON INFRAROSSO MONOFASE VASCA CM. 30,5X51X16,5H CON FALSO FONDO FORATO (INCLUSA 1 TESTATA CHIUSURA PIANO MOD.TPA-9)
EN Fry dump singlephase with infra-red heater. Bowl cm. 30,5x51x16,5h with perforated double bottom (included 1 Head end filler strip mod.TPA-9) • **DE** Frittenwanne Einphasig mit Infrarot-strahler. Becke cm. 30,5x51x16,5h mit gelochtem Bodenrost (inbegriffen 1 Abschluss-Element mod.TPA-9) • **FR** Silo a frites monophasé avec infrarouge. Cuve cm 30,5x51x16,5h avec double-fond perforé. (inclus 1 Élément de jonction top mod.TPA-9) • **ES** Contenedor caliente por infrarrojo monofásico. Cuba cm. 30,5x51x16,5h con falso fondo agujereado (incluida 1 Chapa de cierre para top mod.TPA-9)
cm. 40x 90x 28h



⚡ $\frac{1,47 \text{ kW}}{230\text{V~}}$ **1.634,00**
 $\frac{50/60 \text{ Hz}}{48 / 0,26}$

FRY-TOP ELETTRICI - TOP

MOD. _____
COD. _____

DESCRIZIONE/DESCRIPTION/BEZEICHNUNG/DESCRIPTION/DESCRIPCIÓN
DIMENSIONI/DIMENSIONS/ABMESSUNGEN/DIMENSIONS/DIMENSIONES

POTENZA/POWER/LEISTUNG/PUISSANCE/POTENCIA
VOLTAGGIO/VOLTAGE/SPANNUNG/VOLTAGE/VOLTAJE

⚡ kW kcal/h
⚡ kW V~ Hz

PREZZO/PRICE
PREIS/PRIX/PRECIO
KG / M³



FTLT-94ET
19060431

FRY-TOP ELETTRICO LISCIO, PIASTRA CM.36X68 (INCLUSA 1 TESTATA CHIUSURA PIANO MOD.TPA-9)

EN Electric Fry-top smooth griddle, plate cm.36x68 (included 1 Head end filler strip mod.TPA-9) • **DE** Griddleplatte elektrische glatt, platte cm.36x68 (inbegriffen 1 Abschluss-Element mod.TPA-9) • **FR** Plaque électriques lisse, plaque cm.36x68 (inclus 1 Élément de jonction top mod.TPA-9) • **ES** Fry-top eléctrico liso, plancha cm.36x68 (incluida 1 Chapa de cierre para top mod.TPA-9)
cm. 40x 90x 28h



⚡ 7,5 kW **2.319,00**
400V~3N 69 / 0,23
50/60 Hz

FTLT-94ETS
19060434

FRY-TOP ELETTRICO LISCIO CROMATO SUPERCHROME (MOCA APPROVED), PIASTRA CM.36X68 (INCLUSA 1 TESTATA CHIUSURA PIANO MOD.TPA-9)

EN Electric Fry-top smooth chromed griddle SUPERCHROME (Moca Approved), plate cm.36x68 (included 1 Head end filler strip mod.TPA-9) • **DE** Griddleplatte elektrische glatt hartverchromt SUPERCHROME (Moca Approved), platte cm.36x68 (inbegriffen 1 Abschluss-Element mod.TPA-9) • **FR** Plaque électriques lisse chromée SUPERCHROME (Moca Approved), plaque cm.36x68 (inclus 1 Élément de jonction top mod.TPA-9) • **ES** Fry-top eléctrico liso cromado SUPERCHROME (Moca Approved), plancha cm.36x68 (incluida 1 Chapa de cierre para top mod.TPA-9)
cm. 40x 90x 28h

⚡ 7,5 kW **2.906,00**
400V~3N 69 / 0,23
50/60 Hz

FTLT-94ETSS
19060430

FRY-TOP ELETTRICO LISCIO CROMO LUCIDO, PIASTRA CM.36X68 (INCLUSA 1 TESTATA CHIUSURA PIANO MOD.TPA-9)

EN Electric Fry-top smooth POLISHED CHROME, plate cm.36x68 (included 1 Head end filler strip mod.TPA-9) • **DE** Griddleplatte elektrische glatt POLIERTEM CHROM, platte cm.36x68 (inbegriffen 1 Abschluss-Element mod.TPA-9) • **FR** Plaque électriques lisse CHROME POLI, plaque cm.36x68 (inclus 1 Élément de jonction top mod.TPA-9) • **ES** Fry-top eléctrico liso CROMO PULIDO, plancha cm.36x68 (incluida 1 Chapa de cierre para top mod.TPA-9)
cm. 40x 90x 28h

⚡ 7,5 kW **2.906,00**
400V~3N 69 / 0,23
50/60 Hz

FVRT-94ET
19060433

FRY-TOP ELETTRICO RIGATO, PIASTRA CM.36X68 (INCLUSA 1 TESTATA CHIUSURA PIANO MOD.TPA-9)

EN Electric Fry-top grooved griddle, plate cm.36x68 (included 1 Head end filler strip mod.TPA-9) • **DE** Griddleplatte elektrische gerillt, platte cm.36x68 (inbegriffen 1 Abschluss-Element mod.TPA-9) • **FR** Plaque électriques nervurée, plaque cm.36x68 (inclus 1 Élément de jonction top mod.TPA-9) • **ES** Fry-top eléctrico estriado, plancha cm.36x68 (incluida 1 Chapa de cierre para top mod.TPA-9)
cm. 40x 90x 28h



⚡ 7,5 kW **2.463,00**
400V~3N 69 / 0,23
50/60 Hz

FVRT-94ETS
19060436

FRY-TOP ELETTRICO RIGATO CROMATO SUPERCHROME (MOCA APPROVED), PIASTRA CM.36X68 (INCLUSA 1 TESTATA CHIUSURA PIANO MOD.TPA-9)

EN Electric Fry-top grooved chromed griddle SUPERCHROME (Moca Approved), plate cm.36x68 (included 1 Head end filler strip mod.TPA-9) • **DE** Griddleplatte elektrische gerillt hartverchromt SUPERCHROME (Moca Approved), platte cm.36x68 (inbegriffen 1 Abschluss-Element mod.TPA-9) • **FR** Plaque électriques nervurée chromée SUPERCHROME (Moca Approved), plaque cm.36x68 (inclus 1 Élément de jonction top mod.TPA-9) • **ES** Fry-top eléctrico estriado cromado SUPERCHROME (Moca Approved), plancha cm.36x68 (incluida 1 Chapa de cierre para top mod.TPA-9)
cm. 40x 90x 28h

⚡ 7,5 kW **3.048,00**
400V~3N 69 / 0,23
50/60 Hz

FTLT-98ET
19060831

FRY-TOP ELETTRICO LISCIO, PIASTRA CM.76X68 - 2 ZONE DI COTTURA (INCLUSA 1 TESTATA CHIUSURA PIANO MOD.TPA-9)

EN Electric Fry-top smooth griddle, plate cm.76x68 - 2 cooking areas (included 1 Head end filler strip mod.TPA-9) • **DE** Griddleplatte elektrische glatt, platte cm.76x68 - 2 Heizzonen (inbegriffen 1 Abschluss-Element mod.TPA-9) • **FR** Plaque électriques lisse, plaque cm.76x68 - 2 zones de cuisson (inclus 1 Élément de jonction top mod.TPA-9) • **ES** Fry-top eléctrico liso, plancha cm.76x68 - 2 zonas de cocción (incluida 1 Chapa de cierre para top mod.TPA-9)
cm. 80x 90x 28h



⚡ 15 kW **3.435,00**
400V~3N 103 / 0,44
50/60 Hz

FRY-TOP ELETTRICI - TOP

MOD. _____
COD. _____

DESCRIZIONE/DESCRIPTION/BEZEICHNUNG/DESCRIPTION/DESCRIPCIÓN
DIMENSIONI/DIMENSIONS/ABMESSUNGEN/DIMENSIONS/DIMENSIONES

POTENZA/POWER/LEISTUNG/PUISSANCE/POTENCIA
VOLTAGGIO/VOLTAGE/SPANNUNG/VOLTAGE/VOLTAJE

15 kW
400V~3N
50/60 Hz

PREZZO/PRICE
PREIS/PRIX/PRECIO
KG / M³



FTLT-98ETS
19060834

FRY-TOP ELETTRICO LISCIO CROMATO SUPERCHROME (MOCA APPROVED), PIASTRA CM.76X68 - 2 ZONE DI COTTURA (INCLUSA 1 TESTATA CHIUSURA PIANO MOD.TPA-9)

EN Electric Fry-top smooth chromed griddle SUPERCHROME (Moca Approved), plate cm.76x68 - 2 cooking areas (included 1 Head end filler strip mod.TPA-9) • **DE** Griddleplatte elektrische glatt hartverchromt SUPERCHROME (Moca Approved), platte cm.76x68 - 2 Heizzonen (inbegriffen 1 Abschluss-Element mod.TPA-9) • **FR** Plaque électriques lisse chromée SUPERCHROME (Moca Approved), plaque cm.76x68 - 2 zones de cuisson (inclus 1 Élément de jonction top mod.TPA-9) • **ES** Fry-top eléctrico liso cromado SUPERCHROME (Moca Approved), plancha cm.76x68 - 2 zonas de cocción (incluida 1 Chapa de cierre para top mod.TPA-9)

cm. 80x 90x 28h



15 kW
400V~3N
50/60 Hz

4.217,00
103 / 0,44

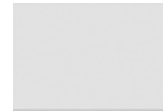

FTLT-98ETSS
19060830

FRY-TOP ELETTRICO LISCIO CROMO LUCIDO, PIASTRA CM.76X68 - 2 ZONE DI COTTURA (INCLUSA 1 TESTATA CHIUSURA PIANO MOD.TPA-9)

EN Electric Fry-top smooth POLISHED CHROME, plate cm.76x68 - 2 cooking areas (included 1 Head end filler strip mod.TPA-9) • **DE** Griddleplatte elektrische glatt POLIERTEM CHROM, platte cm.76x68 - 2 Heizzonen (inbegriffen 1 Abschluss-Element mod.TPA-9) • **FR** Plaque électriques lisse CHROME POLI, plaque cm.76x68 - 2 zones de cuisson (inclus 1 Élément de jonction top mod.TPA-9) • **ES** Fry-top eléctrico liso CROMO PULIDO, plancha cm.76x68 - 2 zonas de cocción (incluida 1 Chapa de cierre para top mod.TPA-9)

cm. 80x 90x 28h

15 kW
400V~3N
50/60 Hz

4.217,00
103 / 0,44

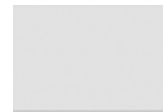

FTLRT-98ET
19060832

FRY-TOP ELETTRICO 1/2 RIGATO + 1/2 LISCIO, PIASTRA CM.76X68 - 2 ZONE DI COTTURA (INCLUSA 1 TESTATA CHIUSURA PIANO MOD.TPA-9)

EN Electric Fry-top 1/2 grooved + 1/2 smooth, plate cm.76x68 - 2 cooking areas (included 1 Head end filler strip mod.TPA-9) • **DE** Griddleplatte elektrische 1/2 gerillt + 1/2 glatt, platte cm.76x68 - 2 Heizzonen (inbegriffen 1 Abschluss-Element mod.TPA-9) • **FR** Plaque électriques 1/2 nervurée + 1/2 lisse, plaque cm.76x68 - 2 zones de cuisson (inclus 1 Élément de jonction top mod.TPA-9) • **ES** Fry-top eléctrico 1/2 estriado + 1/2 liso, plancha cm.76x68 - 2 zonas de cocción (incluida 1 Chapa de cierre para top mod.TPA-9)

cm. 80x 90x 28h



15 kW
400V~3N
50/60 Hz

3.607,00
103 / 0,44



FTLRT-98ETS
19060835

FRY-TOP ELETTRICO 1/2 RIGATO + 1/2 LISCIO CROMATO SUPERCHROME (MOCA APPROVED), PIASTRA CM.76X68 - 2 ZONE DI COTTURA (INCLUSA 1 TESTATA CHIUSURA PIANO MOD.TPA-9)

EN Electric Fry-top 1/2 grooved + 1/2 smooth chromed griddle SUPERCHROME (Moca Approved), plate cm.76x68 - 2 cooking areas (included 1 Head end filler strip mod.TPA-9) • **DE** Griddleplatte elektrische 1/2 gerillt + 1/2 glatt hartverchromt SUPERCHROME (Moca Approved), platte cm.76x68 - 2 Heizzonen (inbegriffen 1 Abschluss-Element mod.TPA-9) • **FR** Plaque électriques 1/2 nervurée + 1/2 lisse chromée SUPERCHROME (Moca Approved), plaque cm.76x68 - 2 zones de cuisson (inclus 1 Élément de jonction top mod.TPA-9) • **ES** Fry-top eléctrico 1/2 estriado + 1/2 liso cromado SUPERCHROME (Moca Approved), plancha cm.76x68 - 2 zonas de cocción (incluida 1 Chapa de cierre para top mod.TPA-9)

cm. 80x 90x 28h



15 kW
400V~3N
50/60 Hz

4.386,00
103 / 0,44



FTRT-98ET
19060833

FRY-TOP ELETTRICO RIGATO, PIASTRA CM.76X68 - 2 ZONE DI COTTURA (INCLUSA 1 TESTATA CHIUSURA PIANO MOD.TPA-9)

EN Electric Fry-top grooved griddle, plate cm.76x68 - 2 cooking areas (included 1 Head end filler strip mod.TPA-9) • **DE** Griddleplatte elektrische gerillt, platte cm.76x68 - 2 Heizzonen (inbegriffen 1 Abschluss-Element mod.TPA-9) • **FR** Plaque électriques nervurée, plaque cm.76x68 - 2 zones de cuisson (inclus 1 Élément de jonction top mod.TPA-9) • **ES** Fry-top eléctrico estriado, plancha cm.76x68 - 2 zonas de cocción (incluida 1 Chapa de cierre para top mod.TPA-9)

cm. 80x 90x 28h



15 kW
400V~3N
50/60 Hz

3.782,00
103 / 0,44



FRY-TOP ELETTRICI - TOP

MOD. _____
COD. _____

DESCRIZIONE/DESCRIPTION/BEZEICHNUNG/DESCRIPTION/DESCRIPCIÓN
DIMENSIONI/DIMENSIONS/ABMESSUNGEN/DIMENSIONS/DIMENSIONES

POTENZA/POWER/LEISTUNG/PUISSANCE/POTENCIA
VOLTAGGIO/VOLTAGE/SPANNUNG/VOLTAGE/VOLTAJE

⚡ kW _____
400V~3N
kcal/h _____
V~
Hz _____

PREZZO/PRICE
PREIS/PRIX/PRECIO
KG / M³



FTRT-98ETS
19060836

FRY-TOP ELETTRICO RIGATO CROMATO SUPERCHROME (MOCA APPROVED), PIASTRA CM.76X68 - 2 ZONE DI COTTURA (INCLUSA 1 TESTATA CHIUSURA PIANO MOD. TPA-9)

EN Electric Fry-top grooved chromed griddle SUPERCHROME (Moca Approved), plate cm.76x68 - 2 cooking areas (included 1 Head end filler strip mod.TPA-9) • **DE** Griddleplatte elektrische gerillt hartverchromt SUPERCHROME (Moca Approved), platte cm.76x68 - 2 Heizzonen (inbegriffen 1 Abschluss-Element mod.TPA-9) • **FR** Plaque électriques nervurée chromée SUPERCHROME (Moca Approved), plaque cm.76x68 - 2 zones de cuisson (inclus 1 Élément de jonction top mod.TPA-9) • **ES** Fry-top eléctrico estriado cromado SUPERCHROME (Moca Approved), plancha cm.76x68 - 2 zonas de cocción (incluida 1 Chapa de cierre para top mod.TPA-9)

cm. 80x 90x 28h



⚡ 15 kW _____ **4.556,00**
400V~3N _____ 103 / 0,44
50/60 Hz _____



FRTL-912ET
1906123B

FRY-TOP ELETTRICO LISCIO, PIASTRA CM.110,5X65 - 3 ZONE DI COTTURA (INCLUSA 1 TESTATA CHIUSURA PIANO MOD. TPA-9)

EN Electric Fry-top smooth griddle, plate cm.110,5x65 - 3 cooking areas (included 1 Head end filler strip mod.TPA-9) • **DE** Griddleplatte elektrische glatt, platte cm.110,5x65 - 3 Heizzonen (inbegriffen 1 Abschluss-Element mod.TPA-9) • **FR** Plaque électriques lisse, plaque cm.110,5x65 - 3 zones de cuisson (inclus 1 Élément de jonction top mod.TPA-9) • **ES** Fry-top eléctrico liso, plancha cm.110,5x65 - 3 zonas de cocción (incluida 1 Chapa de cierre para top mod.TPA-9)

cm. 120x 90x 28h



⚡ 22,5 kW _____ **5.593,00**
400V~3N _____ 161 / 0,64
50/60 Hz _____

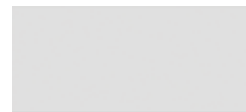

FRTL-912ETS
1906123E

FRY-TOP ELETTRICO LISCIO CROMATO SUPERCHROME (MOCA APPROVED), PIASTRA CM.110,5X65 - 3 ZONE DI COTTURA (INCLUSA 1 TESTATA CHIUSURA PIANO MOD.TPA-9)

EN Electric Fry-top smooth chromed griddle SUPERCHROME (Moca Approved), plate cm.110,5x65 - 3 cooking areas (included 1 Head end filler strip mod.TPA-9) • **DE** Griddleplatte elektrische glatt hartverchromt SUPERCHROME (Moca Approved), platte cm.110,5x65 - 3 Heizzonen (inbegriffen 1 Abschluss-Element mod.TPA-9) • **FR** Plaque électriques lisse chromée SUPERCHROME (Moca Approved), plaque cm.110,5x65 - 3 zones de cuisson (inclus 1 Élément de jonction top mod.TPA-9) • **ES** Fry-top eléctrico liso cromado SUPERCHROME (Moca Approved), plancha cm.110,5x65 - 3 zonas de cocción (incluida 1 Chapa de cierre para top mod.TPA-9)

cm. 120x 90x 28h

⚡ 22,5 kW _____ **6.469,00**
400V~3N _____ 161 / 0,64
50/60 Hz _____

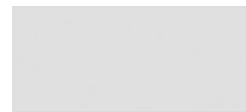

FRLT-912ET
1906123C

FRY-TOP ELETTRICO 1/3 RIGATO + 2/3 LISCIO, PIASTRA CM.110,5X65 - 3 ZONE DI COTTURA (INCLUSA 1 TESTATA CHIUSURA PIANO MOD.TPA-9)

EN Electric Fry-top 1/3 grooved + 2/3 smooth, plate cm.110,5x65 - 3 cooking areas (included 1 Head end filler strip mod.TPA-9) • **DE** Griddleplatte elektrische 1/3 gerillt + 2/3 glatt, platte cm.110,5x65 - 3 Heizzonen (inbegriffen 1 Abschluss-Element mod.TPA-9) • **FR** Plaque électriques 1/3 nervurée + 2/3 lisse, plaque cm.110,5x65 - 3 zones de cuisson (inclus 1 Élément de jonction top mod.TPA-9) • **ES** Fry-top eléctrico 1/3 estriado + 2/3 liso, plancha cm.110,5x65 - 3 zonas de cocción (incluida 1 Chapa de cierre para top mod.TPA-9)

cm. 120x 90x 28h



⚡ 22,5 kW _____ **5.965,00**
400V~3N _____ 161 / 0,64
50/60 Hz _____



FRLT-912ETS
1906123F

FRY-TOP ELETTRICO 1/3 RIGATO + 2/3 LISCIO CROMATO SUPERCHROME (MOCA APPROVED), PIASTRA CM.110,5X65 - 3 ZONE DI COTTURA (INCLUSA 1 TESTATA CHIUSURA PIANO MOD.TPA-9)

EN Electric Fry-top 1/3 grooved + 2/3 smooth chromed griddle SUPERCHROME (Moca Approved), plate cm.110,5x65 - 3 cooking areas (included 1 Head end filler strip mod.TPA-9) • **DE** Griddleplatte elektrische 1/3 gerillt + 2/3 glatt hartverchromt SUPERCHROME (Moca Approved), platte cm.110,5x65 - 3 Heizzonen (inbegriffen 1 Abschluss-Element mod.TPA-9) • **FR** Plaque électriques 1/3 nervurée + 2/3 lisse chromée SUPERCHROME (Moca Approved), plaque cm.110,5x65 - 3 zones de cuisson (inclus 1 Élément de jonction top mod.TPA-9) • **ES** Fry-top eléctrico 1/3 estriado + 2/3 liso cromado SUPERCHROME (Moca Approved), plancha cm.110,5x65 - 3 zonas de cocción (incluida 1 Chapa de cierre para top mod.TPA-9)

cm. 120x 90x 28h

⚡ 22,5 kW _____ **6.841,00**
400V~3N _____ 161 / 0,64
50/60 Hz _____



FRY-TOP A GAS - TOP

MOD. _____
COD. _____

DESCRIZIONE/DESCRIPTION/BEZEICHNUNG/DESCRIPTION/DESCRIPCIÓN
DIMENSIONI/DIMENSIONS/ABMESSUNGEN/DIMENSIONS/DIMENSIONES

POTENZA/POWER/LEISTUNG/PUISSANCE/POTENCIA
VOLTAGGIO/VOLTAGE/SPANNUNG/VOLTAGE/VOLTAJE

9 kW
7.7440 kcal/h

PREZZO/PRICE
PREIS/PRIX/PRECIO
KG / M³



FTLT-94G
19230451

FRY-TOP GAS LISCIO, PIASTRA CM.36X68 (INCLUSA 1 TESTATA CHIUSURA PIANO MOD.TPA-9)
EN Gas Fry-top smooth griddle, plate cm.36x68 (included 1 Head end filler strip mod.TPA-9) • **DE** Gas-griddleplatte glatt, platte cm.36x68 (inbegriffen 1 Abschluss-Element mod.TPA-9) • **FR** Plaque gaz lisse, plaque cm.36x68 (inclus 1 Elément de jonction top mod.TPA-9) • **ES** Fry-top gas liso, plancha cm.36x68 (incluida 1 Chapa de cierre para top mod.TPA-9)
cm. 40x 90x 28h



9 kW
7.7440 kcal/h

2.397,00
71 / 0,23

FTLT-94GS
19230454

FRY-TOP GAS LISCIO CROMATO SUPERCHROME (MOCA APPROVED), PIASTRA CM.36X68 (INCLUSA 1 TESTATA CHIUSURA PIANO MOD.TPA-9)
EN Gas Fry-top smooth chromed griddle SUPERCHROME (Moca Approved), plate cm.36x68 (included 1 Head end filler strip mod.TPA-9) • **DE** Gas-griddleplatte glatt hartverchromt SUPERCHROME (Moca Approved), platte cm.36x68 (inbegriffen 1 Abschluss-Element mod.TPA-9) • **FR** Plaque gaz lisse chromée SUPERCHROME (Moca Approved), plaque cm.36x68 (inclus 1 Elément de jonction top mod.TPA-9) • **ES** Fry-top gas liso cromado SUPERCHROME (Moca Approved), plancha cm.36x68 (incluida 1 Chapa de cierre para top mod.TPA-9)
cm. 40x 90x 28h

9 kW
7.7440 kcal/h

2.872,00
71 / 0,23

FTLT-94GSS
19230450

FRY-TOP GAS LISCIO CROMO LUCIDO, PIASTRA CM.36X68 (INCLUSA 1 TESTATA CHIUSURA PIANO MOD.TPA-9)
EN Gas Fry-top smooth POLISHED CHROME, plate cm.36x68 (included 1 Head end filler strip mod.TPA-9) • **DE** Gas-griddleplatte glatt POLIERTEM CHROM, platte cm.36x68 (inbegriffen 1 Abschluss-Element mod.TPA-9) • **FR** Plaque gaz lisse CHROME POLI, plaque cm.36x68 (inclus 1 Elément de jonction top mod.TPA-9) • **ES** Fry-top gas liso CROMO PULIDO, plancha cm.36x68 (incluida 1 Chapa de cierre para top mod.TPA-9)
cm. 40x 90x 28h

9 kW
7.7440 kcal/h

2.872,00
71 / 0,23

FVRT-94G
19230453

FRY-TOP GAS RIGATO, PIASTRA CM.36X68 (INCLUSA 1 TESTATA CHIUSURA PIANO MOD.TPA-9)
EN Gas Fry-top grooved griddle, plate cm.36x68 (included 1 Head end filler strip mod.TPA-9) • **DE** Gas-griddleplatte gerillt, platte cm.36x68 (inbegriffen 1 Abschluss-Element mod.TPA-9) • **FR** Plaque gaz nervurée, plaque cm.36x68 (inclus 1 Elément de jonction top mod.TPA-9) • **ES** Fry-top gas estriado, plancha cm.36x68 (incluida 1 Chapa de cierre para top mod.TPA-9)
cm. 40x 90x 28h



9 kW
7.7440 kcal/h

2.512,00
71 / 0,23

FVRT-94GS
19230456

FRY-TOP GAS RIGATO CROMATO SUPERCHROME (MOCA APPROVED), PIASTRA CM.36X68 (INCLUSA 1 TESTATA CHIUSURA PIANO MOD.TPA-9)
EN Gas Fry-top grooved chromed griddle SUPERCHROME (Moca Approved), plate cm.36x68 (included 1 Head end filler strip mod.TPA-9) • **DE** Gas-griddleplatte gerillt hartverchromt SUPERCHROME (Moca Approved), platte cm.36x68 (inbegriffen 1 Abschluss-Element mod.TPA-9) • **FR** Plaque gaz nervurée chromée SUPERCHROME (Moca Approved), plaque cm.36x68 (inclus 1 Elément de jonction top mod.TPA-9) • **ES** Fry-top gas estriado cromado SUPERCHROME (Moca Approved), plancha cm.36x68 (incluida 1 Chapa de cierre para top mod.TPA-9)
cm. 40x 90x 28h

9 kW
7.7440 kcal/h

3.006,00
71 / 0,23

FTLT-98G
19230851

FRY-TOP GAS LISCIO, PIASTRA CM.76X68 - 2 ZONE DI COTTURA (INCLUSA 1 TESTATA CHIUSURA PIANO MOD. TPA-9)
EN Gas Fry-top smooth griddle, plate cm.76x68 - 2 cooking areas (included 1 Head end filler strip mod.TPA-9) • **DE** Gas-griddleplatte glatt, platte cm.76x68 - 2 Heizzonen (inbegriffen 1 Abschluss-Element mod.TPA-9) • **FR** Plaque gaz lisse, plaque cm.76x68 - 2 zones de cuisson (inclus 1 Elément de jonction top mod.TPA-9) • **ES** Fry-top gas liso, plancha cm.76x68 - 2 zonas de cocción (incluida 1 Chapa de cierre para top mod.TPA-9)
cm. 80x 90x 28h



18 kW
15.480 kcal/h

3.676,00
108 / 0,44

FRY-TOP A GAS - TOP

MOD. _____
COD. _____

DESCRIZIONE/DESCRIPTION/BEZEICHNUNG/DESCRIPTION/DESCRIPCIÓN
DIMENSIONI/DIMENSIONS/ABMESSUNGEN/DIMENSIONS/DIMENSIONES

POTENZA/POWER/LEISTUNG/PUISSANCE/POTENCIA
VOLTAGGIO/VOLTAGE/SPANNUNG/VOLTAGE/VOLTAJE

18 kW
15.480 kcal/h

PREZZO/PRICE
PREIS/PRIX/PRECIO
KG / M³



FTLT-98GS
19230854

FRY-TOP GAS LISCIO CROMATO SUPERCHROME (MOCA APPROVED), PIASTRA CM.76X68 - 2 ZONE DI COTTURA (INCLUSA 1 TESTATA CHIUSURA PIANO MOD.TPA-9)

EN Gas Fry-top smooth chromed griddle SUPERCHROME (Moca Approved), plate cm.76x68 - 2 cooking areas (included 1 Head end filler strip mod.TPA-9) • **DE** Gas-griddleplatte glatt hartverchromt SUPERCHROME (Moca Approved), platte cm.76x68 - 2 Heizzonen (inbegriffen 1 Abschluss-Element mod.TPA-9) • **FR** Plaque gaz lisse chromée SUPERCHROME (Moca Approved), plaque cm.76x68 - 2 zones de cuisson (inclus 1 Élément de jonction top mod.TPA-9) • **ES** Fry-top gas liso cromado SUPERCHROME (Moca Approved), plancha cm.76x68 - 2 zonas de cocción (incluida 1 Chapa de cierre para top mod.TPA-9)
cm. 80x 90x 28h



18 kW
15.480 kcal/h

4.573,00
108 / 0,44

FTLT-98GSS
19230850

FRY-TOP GAS LISCIO CROMO LUCIDO, PIASTRA CM.76X68 - 2 ZONE DI COTTURA (INCLUSA 1 TESTATA CHIUSURA PIANO MOD.TPA-9)

EN Gas Fry-top smooth POLISHED CHROME, plate cm.76x68 - 2 cooking areas (included 1 Head end filler strip mod.TPA-9) • **DE** Gas-griddleplatte glatt POLIERTEM CHROM, platte cm.76x68 - 2 Heizzonen (inbegriffen 1 Abschluss-Element mod.TPA-9) • **FR** Plaque gaz lisse CHROME POLI, plaque cm.76x68 - 2 zones de cuisson (inclus 1 Élément de jonction top mod.TPA-9) • **ES** Fry-top gas liso CROMO PULIDO, plancha cm.76x68 - 2 zonas de cocción (incluida 1 Chapa de cierre para top mod.TPA-9)
cm. 80x 90x 28h

18 kW
15.480 kcal/h

4.573,00
108 / 0,44

FTLRT-98G
19230852

FRY-TOP GAS 1/2 RIGATO + 1/2 LISCIO, PIASTRA CM.76X68 - 2 ZONE DI COTTURA (INCLUSA 1 TESTATA CHIUSURA PIANO MOD.TPA-9)

EN Gas Fry-top 1/2 grooved + 1/2 smooth, plate cm.76x68 - 2 cooking areas (included 1 Head end filler strip mod.TPA-9) • **DE** Gas-griddleplatte 1/2 gerillt + 1/2 glatt, platte cm.76x68 - 2 Heizzonen (inbegriffen 1 Abschluss-Element mod.TPA-9) • **FR** Plaque gaz 1/2 nervurée + 1/2 lisse, plaque cm.76x68 - 2 zones de cuisson (inclus 1 Élément de jonction top mod.TPA-9) • **ES** Fry-top gas 1/2 estriado + 1/2 liso, plancha cm.76x68 - 2 zonas de cocción (incluida 1 Chapa de cierre para top mod.TPA-9)
cm. 80x 90x 28h



18 kW
15.480 kcal/h

3.847,00
108 / 0,44

FTLRT-98GS
19230855

FRY-TOP GAS 1/2 RIGATO + 1/2 LISCIO CROMATO SUPERCHROME (MOCA APPROVED), PIASTRA CM.76X68 - 2 ZONE DI COTTURA (INCLUSA 1 TESTATA CHIUSURA PIANO MOD.TPA-9)

EN Gas Fry-top 1/2 grooved + 1/2 smooth chromed griddle SUPERCHROME (Moca Approved), plate cm.76x68 - 2 cooking areas (included 1 Head end filler strip mod.TPA-9) • **DE** Gas-griddleplatte 1/2 gerillt + 1/2 glatt hartverchromt SUPERCHROME (Moca Approved), platte cm.76x68 - 2 Heizzonen (inbegriffen 1 Abschluss-Element mod.TPA-9) • **FR** Plaque gaz 1/2 nervurée + 1/2 lisse chromée SUPERCHROME (Moca Approved), plaque cm.76x68 - 2 zones de cuisson (inclus 1 Élément de jonction top mod.TPA-9) • **ES** Fry-top gas 1/2 estriado + 1/2 liso cromado SUPERCHROME (Moca Approved), plancha cm.76x68 - 2 zonas de cocción (incluida 1 Chapa de cierre para top mod.TPA-9)
cm. 80x 90x 28h

18 kW
15.480 kcal/h

4.748,00
108 / 0,44

FVRT-98G
19230853

FRY-TOP GAS RIGATO, PIASTRA CM.76X68 - 2 ZONE DI COTTURA (INCLUSA 1 TESTATA CHIUSURA PIANO MOD.TPA-9)

EN Gas Fry-top grooved griddle, plate cm.76x68 - 2 cooking areas (included 1 Head end filler strip mod.TPA-9) • **DE** Gas-griddleplatte gerillt, platte cm.76x68 - 2 Heizzonen (inbegriffen 1 Abschluss-Element mod.TPA-9) • **FR** Plaque gaz nervurée, plaque cm.76x68 - 2 zones de cuisson (inclus 1 Élément de jonction top mod.TPA-9) • **ES** Fry-top gas estriado, plancha cm.76x68 - 2 zonas de cocción (incluida 1 Chapa de cierre para top mod.TPA-9)
cm. 80x 90x 28h



18 kW
15.480 kcal/h

4.016,00
108 / 0,44

FRY-TOP A GAS - TOP

MOD. _____
COD. _____

DESCRIZIONE/DESCRIPTION/BEZEICHNUNG/DESCRIPTION/DESCRIPCIÓN
DIMENSIONI/DIMENSIONS/ABMESSUNGEN/DIMENSIONS/DIMENSIONES

POTENZA/POWER/LEISTUNG/PUISSANCE/POTENCIA
VOLTAGGIO/VOLTAGE/SPANNUNG/VOLTAGE/VOLTAJE

⚡ kW
kcal/h

PREZZO/PRICE
PREIS/PRIX/PRECIO
KG / M³



FTRT-98GS
19230856

FRY-TOP GAS RIGATO CROMATO SUPERCHROME (MOCA APPROVED), PIASTRA CM.76X68 - 2 ZONE DI COTTURA (INCLUSA 1 TESTATA CHIUSURA PIANO MOD.TPA-9)
EN Gas Fry-top grooved chromed griddle SUPERCHROME (Moca Approved), plate cm.76x68 - 2 cooking areas (included 1 Head end filler strip mod.TPA-9) • **DE** Gas-griddleplatte gerillt hartverchromt SUPERCHROME (Moca Approved), platte cm.76x68 - 2 Heizzonen (inbegriffen 1 Abschluss-Element mod.TPA-9) • **FR** Plaque gaz nervurée chromée SUPERCHROME (Moca Approved), plaque cm.76x68 - 2 zones de cuisson (inclus 1 Élément de jonction top mod.TPA-9) • **ES** Fry-top gas estriado cromado SUPERCHROME (Moca Approved), plancha cm.76x68 - 2 zonas de cocción (incluida 1 Chapa de cierre para top mod.TPA-9)
cm. 80x 90x 28h



⚡ 18 kW
15.480 kcal/h

4.927,00
108 / 0,44



FTLT-912G
1923125B

FRY-TOP GAS LISCIO, PIASTRA CM.110,5X65 - 3 ZONE DI COTTURA (INCLUSA 1 TESTATA CHIUSURA PIANO MOD.TPA-9)
EN Gas Fry-top smooth griddle, plate cm.110,5x65 - 3 cooking areas (included 1 Head end filler strip mod.TPA-9) • **DE** Gas-griddleplatte glatt, platte cm.110,5x65 - 3 Heizzonen (inbegriffen 1 Abschluss-Element mod.TPA-9) • **FR** Plaque gaz lisse, plaque cm.110,5x65 - 3 zones de cuisson (inclus 1 Élément de jonction top mod.TPA-9) • **ES** Fry-top gas liso, plancha cm.110,5x65 - 3 zonas de cocción (incluida 1 Chapa de cierre para top mod.TPA-9)
cm. 120x 90x 28h



⚡ 27 kW
23.220 kcal/h

5.983,00
173 / 0,64



FTLT-912GS
1923125E

FRY-TOP GAS LISCIO CROMATO SUPERCHROME (MOCA APPROVED), PIASTRA CM.110,5X65 - 3 ZONE DI COTTURA (INCLUSA 1 TESTATA CHIUSURA PIANO MOD.TPA-9)
EN Gas Fry-top smooth chromed griddle SUPERCHROME (Moca Approved), plate cm.110,5x65 - 3 cooking areas (included 1 Head end filler strip mod.TPA-9) • **DE** Gas-griddleplatte glatt hartverchromt SUPERCHROME (Moca Approved), platte cm.110,5x65 - 3 Heizzonen (inbegriffen 1 Abschluss-Element mod.TPA-9) • **FR** Plaque gaz lisse chromée SUPERCHROME (Moca Approved), plaque cm.110,5x65 - 3 zones de cuisson (inclus 1 Élément de jonction top mod.TPA-9) • **ES** Fry-top gas liso cromado SUPERCHROME (Moca Approved), plancha cm.110,5x65 - 3 zonas de cocción (incluida 1 Chapa de cierre para top mod.TPA-9)
cm. 120x 90x 28h

⚡ 27 kW
23.220 kcal/h

6.852,00
173 / 0,64



FTLRT-912G
1923125C

FRY-TOP GAS 1/3 RIGATO + 2/3 LISCIO, PIASTRA CM.110,5X65 - 3 ZONE DI COTTURA (INCLUSA 1 TESTATA CHIUSURA PIANO MOD.TPA-9)
EN Gas Fry-top 1/3 grooved + 2/3 smooth, plate cm.110,5x65 - 3 cooking areas (included 1 Head end filler strip mod.TPA-9) • **DE** Gas-griddleplatte 1/3 gerillt + 2/3 glatt, platte cm.110,5x65 - 3 Heizzonen (inbegriffen 1 Abschluss-Element mod.TPA-9) • **FR** Plaque gaz 1/3 nervurée + 2/3 lisse, plaque cm.110,5x65 - 3 zones de cuisson (inclus 1 Élément de jonction top mod.TPA-9) • **ES** Fry-top gas 1/3 estriado + 2/3 liso, plancha cm.110,5x65 - 3 zonas de cocción (incluida 1 Chapa de cierre para top mod.TPA-9)
cm. 120x 90x 28h



⚡ 27 kW
23.220 kcal/h

6.353,00
173 / 0,64



FTLRT-912GS
1923125F

FRY-TOP GAS 1/3 RIGATO + 2/3 LISCIO CROMATO SUPERCHROME (MOCA APPROVED), PIASTRA CM.110,5X65 - 3 ZONE DI COTTURA (INCLUSA 1 TESTATA CHIUSURA PIANO MOD.TPA-9)
EN Gas Fry-top 1/3 grooved + 2/3 smooth chromed SUPERCHROME (Moca Approved), plate cm.110,5x65 - 3 cooking areas (included 1 Head end filler strip mod.TPA-9) • **DE** Gas-griddleplatte 1/3 gerillt + 2/3 glatt hartverchromt SUPERCHROME (Moca Approved), platte cm.110,5x65 - 3 Heizzonen (inbegriffen 1 Abschluss-Element mod.TPA-9) • **FR** Plaque gaz 1/3 nervurée + 2/3 lisse chromée AW770:AW833pproved), plaque cm.110,5x65 - 3 zones de cuisson (inclus 1 Élément de jonction top mod.TPA-9) • **ES** Fry-top gas 1/3 estriado + 2/3 liso cromado SUPERCHROME (Moca Approved), plancha cm.110,5x65 - 3 zonas de cocción (incluida 1 Chapa de cierre para top mod.TPA-9)
cm. 120x 90x 28h

⚡ 27 kW
23.220 kcal/h

7.220,00
173 / 0,64



GRIGLIE ELETTRICHE - TOP

MOD. _____
COD. _____

DESCRIZIONE/DESCRIPTION/BEZEICHNUNG/DESCRIPTION/DESCRIPCIÓN
DIMENSIONI/DIMENSIONS/ABMESSUNGEN/DIMENSIONS/DIMENSIONES

POTENZA/POWER/LEISTUNG/PUISSANCE/POTENCIA
VOLTAGGIO/VOLTAGE/SPANNUNG/VOLTAGE/VOLTAJE

⚡ kW kcal/h
V~ Hz

PREZZO/PRICE
PREIS/PRIX/PRECIO
KG / M³



CWKT-94ET **GRIGLIA CONTACT - COTTURA DIRETTA SU RESISTENZA IN ACCIAIO INOX CM. 27X63 RIBALTABILE (INCLUSA 1 TESTATA CHIUSURA PIANO MOD.TPA-9)**
19080431
EN CONTACT Grill threephase - rotatable stainless steel grill cm. 27x63 (included 1 Head end filler strip mod.TPA-9) • **DE** Wurstbrater dreiphasig KONTAKT - Drehbaren Heizelement aus Edelstahl cm. 27x63 (inbegriffen 1 Abschluss-Element mod.TPA-9) • **FR** Grillade triphase CONTACT - Grille inox rotatif cm 27x63 (inclus 1 Élément de jonction top mod.TPA-9) • **ES** Parrilla trifásico CONTACT - Parrilla giratoria de acero inox cm 27x63 (incluida 1 Chapa de cierre para top mod.TPA-9)
cm. 40x 90x 28h



⚡ 5,415 kW **3.180,00**
400V~3N 55 / 0,23
50/60 Hz

CWKT-98ET **GRIGLIA CONTACT - COTTURA DIRETTA SU RESISTENZA IN ACCIAIO INOX CM. 55X63 RIBALTABILE - 2 ZONE COTTURA (INCLUSA 1 TESTATA CHIUSURA PIANO MOD.TPA-9)**
19080831
EN CONTACT Grill threephase - rotatable stainless steel grill cm. 55x63 - 2 cooking areas (included 1 Head end filler strip mod.TPA-9) • **DE** Wurstbrater dreiphasig KONTAKT - Drehbaren Heizelement aus Edelstahl cm. 55x63 - 2 Heizzonen (inbegriffen 1 Abschluss-Element mod.TPA-9) • **FR** Grillade triphase CONTACT - Grille inox rotatif cm 55x63 - 2 zones de cuisson (inclus 1 Élément de jonction top mod.TPA-9) • **ES** Parrilla trifásico CONTACT - Parrilla giratoria de acero inox cm 55x63 - 2 zonas de cocción (incluida 1 Chapa de cierre para top mod.TPA-9)
cm. 80x 90x 28h



⚡ 10,83 kW **4.432,00**
400V~3N 85 / 0,44
50/60 Hz

CWT-94ET **GRIGLIA TRIFASE GRIGLIA IN ACCIAIO INOX CM. 38X66 REGOLABILE (INCLUSA 1 TESTATA CHIUSURA PIANO MOD. TPA-9)**
19080430
EN Grill threephase - Stainless steel grill cm. 38x66 (included 1 Head end filler strip mod.TPA-9) • **DE** Wurstbrater dreiphasig - Einstellbarer Rost aus Nirosta cm. 38x66 (inbegriffen 1 Abschluss-Element mod.TPA-9) • **FR** Grillade triphase - Grille inox cm 38x66 (inclus 1 Élément de jonction top mod.TPA-9) • **ES** Parrilla trifásico - Parrilla de acero inox regulable cm 38x66 (incluida 1 Chapa de cierre para top mod.TPA-9)
cm. 40x 90x 28h



⚡ 7,8 kW **2.465,00**
400V~3N 57 / 0,26
50/60 Hz

CWT-98ET **GRIGLIA TRIFASE N. 2 GRIGLIE IN ACCIAIO INOX CM. 38X66 REGOLABILI 2 ZONE DI COTTURA (INCLUSA 1 TESTATA CHIUSURA PIANO MOD.TPA-9)**
19080830
EN Grill threephase - N. 2 Stainless steel grill cm. 38x66. 2 cooking areas (included 1 Head end filler strip mod.TPA-9) • **DE** Wurstbrater dreiphasig - N. 2 einstellbare Roste aus Nirosta cm. 38x66 - 2 Heizzonen (inbegriffen 1 Abschluss-Element mod.TPA-9) • **FR** Grillade triphase - N. 2 grilles réglables en acier inox cm. 38x66 - 2 zones de cuisson (inclus 1 Élément de jonction top mod.TPA-9) • **ES** Parrilla trifásico - N. 2 Parrillas de acero inox regulable cm 38x66 - 2 zonas de cocción (incluida 1 Chapa de cierre para top mod.TPA-9)
cm. 80x 90x 28h



⚡ 15,6 kW **3.751,00**
400V~3N 87 / 0,51
50/60 Hz

CWT-94G **GRIGLIA GAS-PIETRALAVICA GRIGLIA IN ACCIAIO INOX CM. 38X66 REGOLABILE (INCLUSA 1 TESTATA CHIUSURA PIANO MOD.TPA-9)**
19250450
EN Charcoal grill gas - Stainless steel grill cm. 38x66 (included 1 Head end filler strip mod.TPA-9) • **DE** Gas-Lavasteingrill - Einstellbarer Rost aus Nirosta cm. 38x66 (inbegriffen 1 Abschluss-Element mod.TPA-9) • **FR** Grille à gaz en pierre de lave - Grille inox cm 38x66 (inclus 1 Élément de jonction top mod.TPA-9) • **ES** Parrilla a gas piedra lávica - Parrilla de acero inox regulable cm 38x66 (incluida 1 Chapa de cierre para top mod.TPA-9)
cm. 40x 90x 28h



⚡ 12 kW **2.555,00**
10.320 kcal/h 56 / 0,26

GRIGLIE PIETRA LAVICA A GAS - TOP

MOD. _____
COD. _____

DESCRIZIONE/DESCRIPTION/BEZEICHNUNG/DESCRIPTION/DESCRIPCIÓN
DIMENSIONI/DIMENSIONS/ABMESSUNGEN/DIMENSIONS/DIMENSIONES

POTENZA/POWER/LEISTUNG/PUISSANCE/POTENCIA
VOLTAGGIO/VOLTAGE/SPANNUNG/VOLTAGE/VOLTAJE

⚡ kW _____
kcal/h _____
V~ _____
Hz _____

PREZZO/PRICE
PREIS/PRIX/PRECIO
KG / M³



CWT-98G
19250850

GRIGLIA GAS-PIETRALAVICA N. 2 GRIGLIE IN ACCIAIO INOX CM. 38X66 REGOLABILI 2 ZONE DI COTTURA (INCLUSA 1 TESTATA CHIUSURA PIANO MOD.TPA-9)

EN Charcoal grill gas - N. 2 Stainless steel grill cm. 38x66 2 cooking areas (included 1 Head end filler strip mod.TPA-9) • **DE** Gas-Lavasteingrill - N. 2 einstellbare Roste aus Nirosta cm. 38x66 - 2 Heizzonen (inbegriffen 1 Abschluss-Element mod.TPA-9) • **FR** Grille a gaz en pierre de lave - N. 2 grilles réglables en acier inox cm. 38x66 - 2 zones de cuisson (inclus 1 Élément de jonction top mod.TPA-9) • **ES** Parrilla a gas piedra lávica - N. 2 Parrillas de acero inox regulable cm 38x66 - 2 zonas de cocción (incluida 1 Chapa de cierre para top mod. TPA-9)
cm. 80x 90x 28h



⚡ 24 kW _____
20.640 kcal/h _____
3.969,00
97 / 0,51

F2/8T-94ET
19090432

FRIGGITRICE TRIFASE LT. 8+8 2 VASCHE CM. 14,8X35,5X22,5H - 2 CESTI CM. 12X29X11,5H - FILTRO E COPERCHIO VASCA. PRODUZIONE PATATE: 12 KG/H (INCLUSA 1 TESTATA CHIUSURA PIANO MOD.TPA-9)

EN Fryer threephase 8+8 lts - 2 Bowls cm. 14,8x35,5x22,5h - 2 baskets cm. 12x29x11,5h. Sieve and lid for pan. Production: 12 kg/h (included 1 Head end filler strip mod.TPA-9) • **DE** Friteuse dreiphasig lt. 8+8 - 2 Becken cm. 14,8x35,5x22,5h - 2 Korb cm. 12x29x11,5h. Einlegesieb und Deckel für Becken. Pommes frites: 12 kg/h (inbegriffen 1 Abschluss-Element mod.TPA-9) • **FR** Friteuse triphase Lt. 8+8 - 2 Cuve cm. 14,8x35,5x22,5h - 2 Panier cm. 12x29x11,5h. Filtre, couvercle pour cuve. Production de pommes frites: 12 kg/h (inclus 1 Élément de jonction top mod.TPA-9) • **ES** Freidoras trifásico 8+8 lt. - 2Cuba cm. 14,8x35,5x22,5h - 2 cesta cm. 12x29x11,5h. Filtro y tapa para cuba. Prod. patatas: 12 Kg/h (incluida 1 Chapa de cierre para top mod.TPA-9)
cm. 40x 90x 28h



⚡ 12 kW _____
400V~3N _____
230V~3 _____
50/60 Hz _____
3.665,00
58 / 0,23

F13T-94ET
19090430

FRIGGITRICE TRIFASE LT. 13 VASCA CM. 30,5X34X22,5H - 1 CESTO CM. 28X29X10H FILTRO E COPERCHIO VASCA - PRODUZIONE PATATE: 10 KG/H (INCLUSA 1 TESTATA CHIUSURA PIANO MOD.TPA-9)

EN Fryer threephase 13 lts - Bowl cm. 30,5x34x22,5h 1 basket cm. 28x29x10h - Sieve and lid for pan Production: 10 kg/h (included 1 Head end filler strip mod.TPA-9) • **DE** Friteuse dreiphasig lt. 13 - Becken cm. 30,5x34x22,5h - 1 Korb cm. 28x29x10h - Einlegesieb und Deckel für Becken - Pommes frites: 10 kg/h (inbegriffen 1 Abschluss-Element mod. TPA-9) • **FR** Friteuse triphase Lt. 13 - Cuve cm. 30,5x34x22,5h - 1 Panier cm. 28x29x10h - Filtre, couvercle pour cuve Production de pommes frites: 10 kg/h (inclus 1 Élément de jonction top mod.TPA-9) • **ES** Freidoras trifásico 13 lt. - Cuba cm. 30,5x34x22,5h - 1 cesta cm. 28x29x10h - Filtro y tapa para cuba. Prod. patatas: 10 Kg/h (incluida 1 Chapa de cierre para top mod.TPA-9)
cm. 40x 90x 28h



⚡ 10,95 kW _____
400V~3N _____
50/60 Hz _____
2.813,00
55 / 0,23

F2/13T-98ET
19090830

FRIGGITRICE TRIFASE LT. 13+13 2 VASCHE CM. 30,5X34X22,5H - 2 CESTI CM. 28X29X10H 2 FILTRI E COPERCHI VASCHE - PRODUZIONE PATATE: 20 KG/H (INCLUSA 1 TESTATA CHIUSURA PIANO MOD.TPA-9)

EN Fryer threephase 13+13 lts - 2 pans cm. 30,5x34x22,5h 2 baskets cm. 28x29x10h - 2 sieves and lids for pan Production: 20 kg/h (included 1 Head end filler strip mod.TPA-9) • **DE** Friteuse dreiphasig lt. 13+13 - 2 Becken cm. 30,5x34x22,5h 2 Körbe cm. 28x29x10h - Einlegesieb und Deckel für Becken - Pommes frites: 20 kg/h (inbegriffen 1 Abschluss-Element mod.TPA-9) • **FR** Friteuse triphase Lt. 13+13 - 2 cuves cm. 30,5x34x22,5h 2 paniers cm. 28x29x10h - 2 filtres, couvercles pour cuve Production de pommes frites: 20 kg/h (inclus 1 Élément de jonction top mod.TPA-9) • **ES** Freidoras trifásico 13+13 lt. - 2 cubas cm. 30,5x34x22,5h - 2 cestas cm. 28x29x10h - 2 filtros y tapas para cubas Prod. patatas: 20 Kg/h (incluida 1 Chapa de cierre para top mod.TPA-9)
cm. 80x 90x 28h



⚡ 21,9 kW _____
400V~3N _____
50/60 Hz _____
4.088,00
75 / 0,44

FRIGGITRICI A GAS - TOP

MOD. _____
COD. _____

DESCRIZIONE/DESCRIPTION/BEZEICHNUNG/DESCRIPTION/DESCRIPCIÓN
DIMENSIONI/DIMENSIONS/ABMESSUNGEN/DIMENSIONS/DIMENSIONES

POTENZA/POWER/LEISTUNG/PUISSANCE/POTENCIA
VOLTAGGIO/VOLTAGE/SPANNUNG/VOLTAGE/VOLTAJE

⚡ kW
kcal/h

PREZZO/PRICE
PREIS/PRIX/PRECIO
KG / M³



F2/8T-94G
19260452

FRIGGITRICE GAS LT. 8+8 - 2 VASCHE CM. 15X35X23H 2 CESTI CM. 12X30X9,5H. FILTRO E COPERCHIO VASCA. PROD. PATATE: 12 KG/H (INCLUSA 1 TESTATA CHIUSURA PIANO MOD.TPA-9)

EN Gas Fryer 8+8 lts - 2 pans cm. 15x35x23h 2 baskets cm. 12x30x9,5h. Sieve and lid for pan. Production: 12 kg/h (included 1 Head end filler strip mod.TPA-9) • **DE** Gas-Friteuse lt. 8+8 - 2 Becken cm. 15x35x23h 2 Körbe cm. 12x30x9,5h. Einlegesieb und Deckel für Becken. Pommes frites: 12 kg/h (inbegriffen 1 Abschluss-Element mod.TPA-9) • **FR** Friteuse à gaz lt. 8+8 - 2 cuves cm. 15x35x23h 2 paniers cm. 12x30x9,5h. Filtre, couvercle pour cuve. Production de pommes frites: 12 kg/h (inclus 1 Élément de jonction top mod.TPA-9) • **ES** Freidoras a gas 8+8 lt. - 2 cubas cm. 15x35x23h 2 cestas cm. 12x30x9,5h. Filtro y tapa para cuba. Prod. patatas: 12 Kg/h (incluida 1 Chapa de cierre para top mod.TPA-9)
cm. 40x 90x 28h



⚡ 9 kW
7.740 kcal/h

4.296,00
58 / 0,23

F13T-94G
19260450

FRIGGITRICE GAS LT. 13 - VASCA CM. 31,5X34,5X22,5H 1 CESTO CM. 28X29X10H - FILTRO E COPERCHIO VASCA. PROD. PATATE: 10 KG/H (INCLUSA 1 TESTATA CHIUSURA PIANO MOD.TPA-9)

EN Gas Fryer 13 lts - Bowl cm. 31,5x34,5x22,5h - 1 basket cm. 28x29x10h - Sieve and lid for pan Production: 10 kg/h (included 1 Head end filler strip mod.TPA-9) • **DE** Gas-Friteuse lt. 13 - Becken cm. 31,5x34,5x22,5h - 1 Korb cm. 28x29x10h - Einlegesieb und Deckel für Becken - Pommes frites: 10 kg/h (inbegriffen 1 Abschluss-Element mod.TPA-9) • **FR** Friteuse à gaz lt. 13 - Cuve cm. 31,5x34,5x22,5h - 1 Panier cm. 28x29x10h - Filtre, couvercle pour cuve Production de pommes frites: 10 kg/h (inclus 1 Élément de jonction top mod.TPA-9) • **ES** Freidoras a gas 13 lt. - Cuba cm. 31,5x34,5x22,5h - 1 cesta cm. 28x29x10h - Filtro y tapa para cuba Prod. patatas: 10 Kg/h (incluida 1 Chapa de cierre para top mod.TPA-9)
cm. 40x 90x 28h



⚡ 12 kW
10.320 kcal/h

3.139,00
60 / 0,23

F2/13T-98G
19260850

FRIGGITRICE GAS LT. 13+13 2 VASCHE CM. 31,5X34,5X22,5H - 2 CESTI CM. 28X29X10H 2 FILTRI E COPERCHI VASCHE - PROD. PATATE: 20 KG/H (INCLUSA 1 TESTATA CHIUSURA PIANO MOD.TPA-9)

EN Gas Fryer 13+13 lts - 2 pans cm. 31,5x34,5x22,5h 2 baskets cm. 28x29x10h - 2 sieves and lids for pan Production: 20 kg/h (included 1 Head end filler strip mod.TPA-9) • **DE** Gas-Friteuse lt. 13+13 - 2 Becken cm. 31,5x34,5x22,5h 2 Körbe cm. 28x29x10h - Einlegesieb und Deckel für Becken - Pommes frites: 20 kg/h (inbegriffen 1 Abschluss-Element mod.TPA-9) • **FR** Friteuse à gaz lt. 13+13 - 2 cuves cm. 31,5x34,5x22,5h 2 paniers cm. 28x29x10h - 2 filtres, couvercles pour cuve Production de pommes frites: 20 kg/h (inclus 1 Élément de jonction top mod.TPA-9) • **ES** Freidoras a gas 13+13 lt. - 2 cubas cm. 31,5x34,5x22,5h 2 cestas cm. 28x29x10h - 2 filtros y tapas para cubas. Prod. patatas: 20 Kg/h (incluida 1 Chapa de cierre para top mod.TPA-9)
cm. 80x 90x 28h



⚡ 24 kW
20.640 kcal/h

5.000,00
81 / 0,44

MFV-98ET
09490830

BASE CON FORNO ELETTRICO VENTILATO CM. 55X36X34H, TEMP: 50÷300°C, CON 1 GRIGLIA CM.53X32,5 GN1/1 (NON SOVRAPPORRE ELEMENTI AD INDUZIONE)

EN Stand with electric fan oven cm. 55x36x34h, temp: 50÷300°C, with 1 grid cm.53x32,5 GN1/1 (no induction top) • **DE** unterbau mit Elektro-Heißluftofen cm. 55x36x34h, temp: 50÷300°C, mit 1 Rost cm.53x32,5 GN1/1 (nicht Induktions) • **FR** placard avec Four à chaleur tournante électrique cm. 55x36x34h, temp: 50÷300°C, avec 1 grille cm.53x32,5 GN1/1 (il faut pas de induction) • **ES** mueble con Horno eléctrico ventilado cm. 55x36x34h, temp: 50÷300°C, con 1 parilla cm.53x32,5 GN1/1 (no inducción)
cm. 80x 83x 57h



⚡ 5,32 kW
400V~3N
230V~3
50/60 Hz

3.894,00
80 / 0,62

CMF-98
09490800

COPERCHIO PER MFV-98E

EN Lid for MFV-98E • **DE** Berichterstattung für MFV-98E • **FR** Couvercle pour MFV-98E • **ES** cubertura para MFV-98E
cm. 80x 82,5x 2,8h

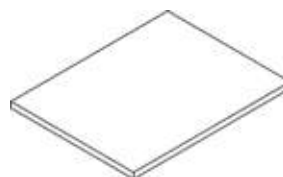

277,00
6 / 0,04

MOD. _____
COD. _____

DESCRIZIONE/DESCRIPTION/BEZEICHNUNG/DESCRIPTION/DESCRIPCIÓN
DIMENSIONI/DIMENSIONS/ABMESSUNGEN/DIMENSIONS/DIMENSIONES

POTENZA/POWER/LEISTUNG/PUISSANCE/POTENCIA
VOLTAGGIO/VOLTAGE/SPANNUNG/VOLTAGE/VOLTAJE

⚡ kW kcal/h
⚡ kW V~ Hz

PREZZO/PRICE
PREIS/PRIX/PRECIO
KG / M³



MPI-94
09410403

BASE CON PORTA PER INDUZIONE
EN Stand with door for induction top • **DE** Unterbau für Induktions mit Tür • **FR** Placard pour induction avec porte • **ES** Mueble base para inducción con puerta
cm. 40x 81x 57h



805,00
22 / 0,26

MPI-98
09410803

cm. 80x 81x 57h



930,00
29 / 0,51

M-92
09410200

BASE NEUTRA
EN Stand • **DE** Unterbau • **FR** Placard • **ES** Mueble base
cm. 20x 78,5x 57h



519,00
14 / 0,25

M-93
09410300

BASE NEUTRA A GIORNO
EN Open Stand • **DE** Offener Unterbau • **FR** Placard ouvert • **ES** Mueble base abierto
cm. 30x 78,5x 57h



502,00
16 / 0,26

M-94
09410400

cm. 40x 78,5x 57h



552,00
19 / 0,26

M-96
09410600

cm. 60x 78,5x 57h



630,00
23 / 0,51

M-98
09410800

cm. 80x 78,5x 57h



677,00
26 / 0,51

M-912
09411200

cm. 120x 78,5x 57h



905,00
38 / 0,75

MOD. _____
COD. _____

DESCRIZIONE/DESCRIPTION/BEZEICHNUNG/DESCRIPTION/DESCRIPCIÓN
DIMENSIONI/DIMENSIONS/ABMESSUNGEN/DIMENSIONS/DIMENSIONES

POTENZA/POWER/LEISTUNG/PUISSANCE/POTENCIA
VOLTAGGIO/VOLTAGE/SPANNUNG/VOLTAGE/VOLTAJE

⚡ kW kcal/h
⚡ kw V~ Hz

PREZZO/PRICE
PREIS/PRIX/PRECIO
KG / M³



PM-63/73/93-DX PORTA 300 DESTRA
08430302 **EN** Right door 300 • **DE** Rechte tür 300 • **FR** Porte droite 300 • **ES**
Puerta derecha 300
cm. 29,5x 2,5x 47,5h



197,00
3 / 0,01

PM-64/74/94-DX PORTA 400 DESTRA
08430402 **EN** Right door 400 • **DE** Rechte tür 400 • **FR** Porte droite 400 • **ES**
Puerta derecha 400
cm. 39,5x 2,5x 47,5h



204,00
3.5 / 0,02

PM-63/73/93-SX PORTA 300 SINISTRA
08430303 **EN** Left door 300 • **DE** Linke tür 300 • **FR** Porte gauche 300 • **ES**
Puerta izquiera 300
cm. 29,5x 2,5x 47,5h

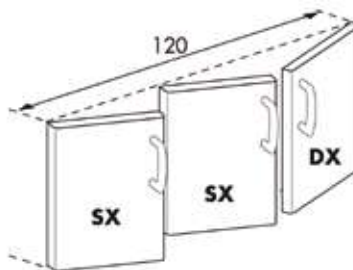

197,00
3 / 0,01

PM-64/74/94-SX PORTA 400 SINISTRA
08430403 **EN** Left door 400 • **DE** Linke tür 400 • **FR** Porte gauche 400 • **ES**
Puerta izquiera 400
cm. 39,5x 2,5x 47,5h

204,00
3.5 / 0,02

C-73/93 CASSETTIERA 300 N. 2 CASSETTI CON 2 BACINELLE INOX, GUIDE TELESCOPICHE.
08440320 **EN** Drawer set 300 N. 2 drawers with 2 inox containers, telescopic guides. • **DE** Schubladen 300 - N. 2 Schubladen mit 2 Chromnickelstahlbehältern, Teleskopeinführungen. • **FR** Tiroirs pour meuble de 300 N. 2 tiroirs avec 2 bacs inox, guides télescopiques. • **ES** Cajonera 300 - N. 2 cajones con 2 contenedores de acero inox, guías telescópicas.
cm. 29,5x 59x 47,5h



766,00
16 / 0,19

C-74/94 CASSETTIERA 400 - N. 2 CASSETTI CON 2 BACINELLE GN 1/1 15H IN PLASTICA, GUIDE TELESCOPICHE.
08440420 **EN** Drawer set 400 - N. 2 drawers with 2 GN 1/1 15h plastic containers, telescopic guides. • **DE** Schubladen - N. 2 Schubladen mit 2 GN 1/1 15h Kunststoffbehältern, Teleskopeinführungen. • **FR** Tiroirs pour meuble de 400 - N. 2 tiroirs avec 2 bacs en plastique GN 1/1 15h, guides télescopiques. • **ES** Cajonera 400 - N. 2 cajones con 2 contenedores GN 1/1 15h de plástico, guías telescópicas.
cm. 39,5x 59x 47,5h



786,00
18 / 0,19

C-76/96 CASSETTIERA 600 N. 2 CASSETTI CON 2 BACINELLE INOX, GUIDE TELESCOPICHE.
08440620 **EN** Drawer set 600 N. 2 drawers with 2 inox containers, telescopic guides. • **DE** Schubladen 600 - N. 2 Schubladen mit 2 Chromnickelstahlbehältern, Teleskopeinführungen. • **FR** Tiroirs pour meuble de 600 N. 2 tiroirs avec 2 bacs inox, guides télescopiques. • **ES** Cajonera 600 - N. 2 cajones con 2 contenedores de acero inox, guías telescópicas.
cm. 59,5x 59x 47,5h



1.086,00
22 / 0,28

MOD. _____
COD. _____

DESCRIZIONE/DESCRIPTION/BEZEICHNUNG/DESCRIPTION/DESCRIPCIÓN
DIMENSIONI/DIMENSIONS/ABMESSUNGEN/DIMENSIONS/DIMENSIONES

POTENZA/POWER/LEISTUNG/PUISSANCE/POTENCIA
VOLTAGGIO/VOLTAGE/SPANNUNG/VOLTAGE/VOLTAJE

⚡ kW kcal/h
⚡ kW V~ Hz

PREZZO/PRICE
PREIS/PRIX/PRECIO
KG / M³



C-78/98
08440820

CASSETTIERA 800 - N. 2 CASSETTI CON 4 BACINELLE GN 1/1 15H IN PLASTICA, GUIDE TELESCOPICHE.

EN Drawer set 800 - N. 2 drawers with 4 GN 1/1 15h plastic containers, telescopic guides. • **DE** Schubladen 800 - N. 2 Schubladen mit 4 GN 1/1 15h Kunststoffbehältern, Telescopeinführungen. • **FR** tiroirs pour meuble de 800 - N. 2 tiroirs avec 4 bacs en plastique GN 1/1 15h, guides télescopiques. • **ES** Cajonera 800 - N. 2 cajones con 4 contenedores GN 1/1 15h de plástico, guías telescópicas.
cm. 79,5x 59x 47,5h



1.105,00
26 / 0,37

D-90
09470001

DIVISORIO BASE NEUTRA

EN Spacer for stand • **DE** Trennwand für offener unterbau • **FR** Separation pour placard ouvert • **ES** Divisorio para mueble base
cm. 5x 78x 38h

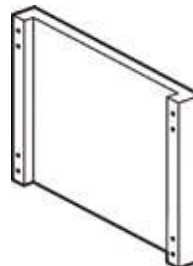

200,00
2.5 / 0,03

PT-74/94
08460002

PORTATEGLIE VANO 400 (GN-1/1) VANO 600 (GN-2/1) 4 RIPIANI INT. 7 CM.

EN Frame for plates 400 (GN-1/1) 600 (GN-2/1) - N. 4 shelves, wheel-base 7 cm. • **DE** Aufflangeschienen für bleche 400 (GN-1/1) 600 (GN-2/1) - N. 4 Etagen, Abstand 7 cm. • **FR** Kit porte-plaques 400 (GN-1/1) 600 (GN-2/1) - N. 4 étagères; 7 cm. • **ES** Portacazuelas 400 (GN-1/1) 600 (GN-2/1) - N. 4 estantes, int. 7 cm.

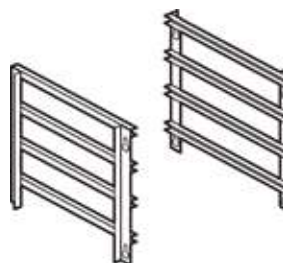

425,00
2.5 / 0,01

PT-78/98
08460012

PORTATEGLIE VANO 800 (GN-2/1) 4 RIPIANI INT. 7 CM.

EN Frame for plates 800 (GN-2/1) 4 Etagen, Abstand 7 cm. • **DE** Aufflangeschienen für bleche 800 (GN-2/1) N. 4 Etagen, Abstand 7 cm. • **FR** Kit porte-plaques 800 (GN-2/1) - N. 4 étagères; 7 cm. • **ES** Portacazuelas 800 (GN-2/1) - N. 4 estantes, int. 7 cm.

568,00
4 / 0,01

531048800 CESTO 1/2 PER F13T-G/E

EN Basket 1/2 for F13T-G/E • **DE** Korb 1/2 zur Friteuse F13T-G/E • **FR** Panier 1/2 pour F13T-G/E • **ES** Cesta 1/2 para F13T-G/E
cm. 13,5x 29x 9h



91,00
0.8 / 0,03



MOD. _____
COD. _____

DESCRIZIONE/DESCRIPTION/BEZEICHNUNG/DESCRIPTION/DESCRIPCIÓN
DIMENSIONI/DIMENSIONS/ABMESSUNGEN/DIMENSIONS/DIMENSIONES

POTENZA/POWER/LEISTUNG/PUISSANCE/POTENCIA
VOLTAGGIO/VOLTAGE/SPANNUNG/VOLTAGE/VOLTAJE

⚡ $\frac{kW}{kcal/h}$ $\frac{kW}{V}$
Hz

PREZZO/PRICE
PREIS/PRIX/PRECIO
KG / M³



CF4-118G
03610850

CUCINA GAS PASSANTE 4 FUOCHI - FORNO GAS PASSANTE STATICO CM. 55X98X34H, TEMP: 150÷300°C, CON 1 GRIGLIA CM. 53X32,5 GN-1/1 E 1 GRIGLIA CM.53X65 GN-2/1 (INCLUSA 1 TESTATA CHIUSURA PIANO MOD.TPC-11)
EN Pass-through gas Range - N. 4 burners on Pass-through traditional gas-oven cm. 55x98x34h, temp: 150÷300°C, with 1 grid cm.53x32,5 GN-1/1 and 1 cm.53x65 GN-2/1 (included 1 Head end filler strip mod.TPC-11) • **DE** Durchgehende Gasherd - N. 4 Kochstellen mit Durchgehende Statischer Gas-Backofen cm. 55x98x34h, temp: 150÷300°C, mit 1 Rost cm.53x32,5 GN-1/1 und 1 cm.53x65 GN-2/1 (inbegriffen 1 Abschluss-Element mod.TPC-11) • **FR** Cuisiniere gaz traversant - N. 4 feux vifs Four à gaz traversant statique cm. 55x98x34h, temp: 150÷300°C, avec 1 grille cm.53x32,5 GN-1/1 et 1 cm.53x65 GN-2/1 (inclus 1 Élément de jonction top mod.TPC-11) • **ES** Cocina a gas pasante - N. 4 quemadores Horno a gas pasante estático cm. 55x98x34h, temp: 150÷300°C, con 1 parilla cm.53x32,5 GN-1/1 y 1 cm.53x65 GN-2/1 (incluida 1 Chapa de cierre para top mod.TPC-11)
cm. 80x 110x 90h



⚡ $\frac{44 kW}{37.840 kcal/h}$ **7.495,00**
181 / 1,15



CF4-118GE
03610860

CUCINA GAS PASSANTE 4 FUOCHI - FORNO ELETTRICO PASSANTE STATICO CM. 55X98X34H, TEMP: 50÷300°C, CON 1 GRIGLIA CM. 53X32,5 GN-1/1 E 1 GRIGLIA CM.53X65 GN-2/1 (INCLUSA 1 TESTATA CHIUSURA PIANO MOD.TPC-11)
EN Pass-through gas Range - N. 4 burners on Pass-through traditional electric oven cm. 55x98x34h, temp: 50÷300°C, with 1 grid cm.53x32,5 GN-1/1 and 1 cm.53x65 GN-2/1 (included 1 Head end filler strip mod.TPC-11) • **DE** Durchgehende Gasherd - N. 4 Kochstellen mit Durchgehende Statischer Elektro-Backofen cm. 55x98x34h, temp: 50÷300°C, mit 1 Rost cm.53x32,5 GN-1/1 und 1 cm.53x65 GN-2/1 (inbegriffen 1 Abschluss-Element mod.TPC-11) • **FR** Cuisiniere gaztraversant - N. 4 feux vifs Four électrique traversant statique cm. 55x98x34h, temp: 50÷300°C, avec 1 grille cm.53x32,5 GN-1/1 et 1 cm.53x65 GN-2/1 (inclus 1 Élément de jonction top mod.TPC-11) • **ES** Cocina a gas pasante - N. 4 quemadores Horno eléctrico pasante estático cm. 55x98x34h, temp: 50÷300°C, con 1 parilla cm.53x32,5 GN-1/1 y 1 cm.53x65 GN-2/1 (incluida 1 Chapa de cierre para top mod.TPC-11)
cm. 80x 110x 90h



⚡ $\frac{34 kW}{29.240 kcal/h}$ **7.654,00**
181 / 1,15

⚡ $\frac{7,5 kW}{400V\sim 3N}$
50/60 Hz



CFQ4-118ET
036G0831

CUCINA ELETTRICA PASSANTE 4 PIASTRE QUADRE - FORNO ELETTRICO PASSANTE STATICO CM. 55X98X34H, TEMP: 50÷300°C, CON 1 GRIGLIA CM. 53X32,5 GN-1/1 E 1 GRIGLIA CM.53X65 GN-2/1 (INCLUSA 1 TESTATA CHIUSURA PIANO MOD.TPA-11)
EN Pass-through Electric range - N. 4 square plates on Pass-through Traditional electric oven cm. 55x98x34h, temp: 50÷300°C, with 1 grid cm.53x32,5 GN-1/1 and 1 cm.53x65 GN-2/1 (included 1 Head end filler strip mod.TPA-11) • **DE** Durchgehende Elektroherd - N. 4 quadratischen Platten mit Durchgehende Statischer Elektro-Backofen cm. 55x98x34h, temp: 50÷300°C, mit 1 Rost cm.53x32,5 GN-1/1 und 1 cm.53x65 GN-2/1 (inbegriffen 1 Abschluss-Element mod.TPA-11) • **FR** Fourneau électrique traversant - N. 4 plaques carrés - Four électrique traversant statique cm. 55x98x34h, temp: 50÷300°C, avec 1 grille cm.53x32,5 GN-1/1 et 1 cm.53x65 GN-2/1 (inclus 1 Élément de jonction top mod.TPA-11) • **ES** Cocina eléctrica pasante - N. 4 planchas cuadradas Horno eléctrico pasante estático cm. 55x98x34h, temp: 50÷300°C, con 1 parilla cm.53x32,5 GN-1/1 y 1 cm.53x65 GN-2/1 (incluida 1 Chapa de cierre para top mod.TPA-11)
cm. 80x 110x 90h



⚡ $\frac{23,5 kW}{400V\sim 3N}$ **9.940,00**
167 / 1,15
50/60 Hz



PC-114G
032B0450

PIANO COTTURA GAS PASSANTE SU MOBILE A GIORNO 2 FUOCHI (INCLUSA 1 TESTATA CHIUSURA PIANO MOD.TPC-11)
EN Pass-through Gas cooking top on open cabinet - 2 burners (included 1 Head end filler strip mod.TPC-11) • **DE** Durchgehende Gas-kochplatte mit offenem Unterbau - 2 Brenner (inbegriffen 1 Abschluss-Element mod.TPC-11) • **FR** Rechaud gaz traversant sur armoire ouvert - 2 feux vifs (inclus 1 Élément de jonction top mod.TPC-11) • **ES** Sobres de cocción pasante gas sobre mueble abierto - 2 quemadores (incluida 1 Chapa de cierre para top mod.TPC-11)
cm. 40x 110x 90h



⚡ $\frac{20 Kw}{17.200 kcal/h}$ **2.316,00**
85 / 0,58



PIANI COTTURA A GAS

MOD. _____
COD. _____

DESCRIZIONE/DESCRIPTION/BEZEICHNUNG/DESCRIPTION/DESCRIPCIÓN
DIMENSIONI/DIMENSIONS/ABMESSUNGEN/DIMENSIONS/DIMENSIONES

POTENZA/POWER/LEISTUNG/PUISSANCE/POTENCIA
VOLTAGGIO/VOLTAGE/SPANNUNG/VOLTAGE/VOLTAJE

⚡ kW _____
kcal/h _____
V~ _____
Hz _____

PREZZO/PRICE
PREIS/PRIX/PRECIO
KG / M³



PC-118G
032B0850

PIANO COTTURA GAS PASSANTE SU MOBILE A GIORNO 4 FUOCHI (INCLUSA 1 TESTATA CHIUSURA PIANO MOD.TPC-11)

EN Pass-through Gas cooking top on open cabinet - 4 burners (included 1 Head end filler strip mod.TPC-11) • **DE** Durchgehende Gas-kochplatte mit offenem Unterbau - 4 Brenner (inbegriffen 1 Abschluss-Element mod.TPC-11) • **FR** Rechaud gaz traversant sur armoire ouvert - 4 feux vifs (inclus 1 Élément de jonction top mod.TPC-11) • **ES** Sobres de cocción gas sobre mueble abierto - 4 quemadores (incluida 1 Chapa de cierre para top mod.TPC-11)

cm. 80x 110x 90h



⚡ 34 kW _____
29.240 kcal/h _____ **3.853,00**
140 / 1,15



PC-554G
03210450

PIANO COTTURA GAS SU MOBILE A GIORNO 1 FUOCO (INCLUSA 1 TESTATA CHIUSURA PIANO MOD.TPC-55)

EN Gas cooking top on open cabinet - 1 burner (included 1 Head end filler strip mod.TPC-55) • **DE** Gas-kochplatte mit offenem Unterbau - 1 Brenner (inbegriffen 1 Abschluss-Element mod.TPC-55) • **FR** Rechaud gaz sur armoire ouvert - 1 feu vif (inclus 1 Élément de jonction top mod.TPC-55) • **ES** Sobres de cocción gas sobre mueble abierto - 1 quemador (incluida 1 Chapa de cierre para top mod.TPC-55)

cm. 40x 55x 90h



⚡ 10 kW _____
8.600 kcal/h _____ **1.772,00**
49 / 0,37



PC-558G
03210850

PIANO COTTURA GAS SU MOBILE A GIORNO 2 FUOCHI (INCLUSA 1 TESTATA CHIUSURA PIANO MOD.TPC-55)

EN Gas cooking top on open cabinet - 2 burners (included 1 Head end filler strip mod.TPC-55) • **DE** Gas-kochplatte mit offenem Unterbau - 2 Brenner (inbegriffen 1 Abschluss-Element mod.TPC-55) • **FR** Rechaud gaz sur armoire ouvert - 2 feux vifs (inclus 1 Élément de jonction top mod.TPC-55) • **ES** Sobres de cocción gas sobre mueble abierto - 2 quemadores (incluida 1 Chapa de cierre para top mod.TPC-55)

cm. 80x 55x 90h



⚡ 17 kW _____
14.620 kcal/h _____ **2.725,00**
78 / 0,62



PCQ-118ET
030D0831

PIANO COTTURA ELETTRICO PASSANTE SU MOBILE A GIORNO - N. 4 PIASTRE QUADRE (INCLUSA 1 TESTATA CHIUSURA PIANO MOD.TPA-11)

EN Pass-through Electric Boiling unit on open cabinet - N. 4 square plates (included 1 Head end filler strip mod.TPA-11) • **DE** Durchgehende Kochplatte Elektrische mit offenem Unterbau N. 4 quadratischen Platten (inbegriffen 1 Abschluss-Element mod.TPA-11) • **FR** Rechaud électriques traversant sur armoire ouvert - N. 4 plaques carrés (inclus 1 Élément de jonction top mod.TPA-11) • **ES** Sobre de cocción eléctrico pasante sobre mueble abierto N. 4 planchas cuadradas (incluida 1 Chapa de cierre para top mod.TPA-11)

cm. 80x 110x 90h



⚡ 16 kW _____
400V~3N _____ **4.893,00**
50/60 Hz _____ 115 / 1,15



PCQ-558ET
03030831

PIANO COTTURA ELETTRICO SU MOBILE A GIORNO - N. 2 PIASTRE QUADRE (INCLUSA 1 TESTATA CHIUSURA PIANO MOD.TPA-55)

EN Electric Boiling unit on open cabinet - N. 2 square plates (included 1 Head end filler strip mod.TPA-55) • **DE** Kochplatte Elektrische mit offenem Unterbau N. 2 quadratischen Platten (inbegriffen 1 Abschluss-Element mod.TPA-55) • **FR** Rechaud électriques sur armoire ouvert - N. 2 plaques carrés (inclus 1 Élément de jonction top mod.TPA-55) • **ES** Sobre de cocción eléctrico sobre mueble abierto N. 2 planchas cuadradas (incluida 1 Chapa de cierre para top mod.TPA-55)

cm. 80x 55x 90h



⚡ 8 kW _____
400V~2N _____ **2.707,00**
230V~3 _____ 60 / 0,62
230V~ _____
50/60 Hz _____



PCI-114ET
030D0433

PIANO COTTURA INDUZIONE PASSANTE 2 ZONE - 2 VETRI CM.35X35 (INCLUSA 1 TESTATA CHIUSURA PIANO MOD.TPA-11)

EN Pass-through induction cooking top 2 zones - 2 glass cm.35x35 (included 1 Head end filler strip mod.TPA-11) • **DE** Durchgehende Induktions-Kochplatte 2 zonen - 2 Glas cm.35x35 (inbegriffen 1 Abschluss-Element mod.TPA-11) • **FR** Plan de cuisson à induction traversant 2 zones - 2 verre cm.35x35 (inclus 1 Élément de jonction top mod.TPA-11) • **ES** Encimera de cocción inducción pasante 2 zonas - 2 vidrio cm.35x35 (incluida 1 Chapa de cierre para top mod.TPA-11)

cm. 40x 110x 90h



⚡ 10 kW _____
400V~3 _____ **9.375,00**
50/60 Hz _____ 65 / 0,58

PIANI COTTURA A INDUZIONE

MOD. _____
COD. _____

DESCRIZIONE/DESCRIPTION/BEZEICHNUNG/DESCRIPTION/DESCRIPCIÓN
DIMENSIONI/DIMENSIONS/ABMESSUNGEN/DIMENSIONS/DIMENSIONES

POTENZA/POWER/LEISTUNG/PUISSANCE/POTENCIA
VOLTAGGIO/VOLTAGE/SPANNUNG/VOLTAGE/VOLTAJE

⚡ kW _____
kcal/h _____
⚡ kw _____
V~ _____
Hz _____

PREZZO/PRICE
PREIS/PRIX/PRECIO
KG / M³



PCI-118ET
030D0833

**PIANO COTTURA INDUZIONE PASSANTE 4 ZONE - 2 VETRI
CM.77X35 (INCLUSA 1 TESTATA CHIUSURA PIANO MOD.
TPA-11)**

EN Pass-through induction cooking top 4 zones - 2 glass cm.75x35 (included 1 Head end filler strip mod.TPA-11) • **DE** Durchgehende Induktions-Kochplatte 4 zonen - 2 Glas cm.75x35 (inbegriffen 1 Abschluss-Element mod.TPA-11) • **FR** Plan de cuisson à induction traversant 4 zones - 2 verre cm.75x35 (inclus 1 Élément de jonction top mod.TPA-11) • **ES** Encimera de cocción inducción pasante 4 zonas - 2 vidrio cm.75x35 (incluida 1 Chapa de cierre para top mod.TPA-11)
cm. 80x 110x 90h



⚡ 20 kW _____ **17.809,00**
400V~3 _____ 115 / 1,15
50/60 Hz _____

PCI-558ET
03030833

**PIANO COTTURA INDUZIONE 2 ZONE - VETRO CM.77X35
(INCLUSA 1 TESTATA CHIUSURA PIANO MOD.TPA-55)**

EN Induction cooking top 2 zones - glass cm.77x35 (included 1 Head end filler strip mod.TPA-55) • **DE** Induktions-Kochplatte 2 zonen - Glas cm.77x35 (inbegriffen 1 Abschluss-Element mod.TPA-55) • **FR** Plan de cuisson à induction 2 zones - Verre cm.77x35 (inclus 1 Élément de jonction top mod.TPA-55) • **ES** Encimera de cocción inducción 2 zonas - Vidrio cm.77x35 (incluida 1 Chapa de cierre para top mod.TPA-55)
cm. 80x 55x 90h



⚡ 10 kW _____ **9.132,00**
400V~3 _____ 59 / 0,62
50/60 Hz _____

TUTTAPIASTRA A GAS CON FORNO

MOD. _____
COD. _____

DESCRIZIONE / DESCRIPTION / BEZEICHNUNG / DESCRIPTION / DESCRIPCIÓN
DIMENSIONI / DIMENSIONS / ABMESSUNGEN / DIMENSIONS / DIMENSIONES

POTENZA / POWER / LEISTUNG / PUISSANCE / POTENCIA
VOLTAGGIO / VOLTAGE / SPANNUNG / VOLTAGE / VOLTAJE

⚡ kW
kcal/h

PREZZO / PRICE
PREIS / PRIX / PRECIO
KG / M³



TPF-1110G
037A1050

TUTTA PIASTRA GAS PASSANTE SU FORNO GAS PASSANTE STATICO CM. 55X98X34H, TEMP: 150÷300°C, CON 1 GRIGLIA CM. 53X32,5 GN-1/1 E 1 GRIGLIA CM.53X65 GN-2/1 - PIASTRA CM 73X79 - 2 VANI NEUTRI CON PORTE (INCLUSA 1 TESTATA CHIUSURA MOD.TPA-11)

EN Pass-through gas Solid top on Pass-through Traditional gas-oven cm. 55x98x34h, temp: 150÷300°C, with 1 grid cm.53x32,5 GN-1/1 and 1 cm.53x65 GN-2/1 - Plate cm. 73x79 - 2 neutral cabinet with doors (included 1 Head end filler strip mod.TPA-11) • **DE** Durchgehende Gas-Kochplatten mit Durchgehende Statischer Gas-Backofen cm. 55x98x34h, temp: 150÷300°C, mit 1 Rost cm.53x32,5 GN-1/1 und 1 cm.53x65 GN-2/1 - Platte cm. 73x79 - 2 Neutrales Schrankelement mit Tür (inbegriffen 1 Abschluss-Element mod.TPA-11) • **FR** Toute plaque gaz traversant sur Four à gaz traversant statique cm. 55x98x34h, temp: 150÷300°C, avec 1 grille cm.53x32,5 GN-1/1 et 1 cm.53x65 GN-2/1 - Plaque cm. 73x79 - 2 Élément neutre avec porte (inclus 1 Élément de jonction top mod.TPA-11) • **ES** Placa de cocción gas pasante sobre Horno a gas pasante estático cm. 55x98x34h, temp: 150÷300°C, con 1 parilla cm.53x32,5 GN-1/1 y 1 cm.53x65 GN-2/1 - Placa cm. 73x79 - 2 armario neutro con puertas (incluida 1 Chapa de cierre para top mod.TPA-11)
cm. 100x 110x 90h



⚡ 22 kW
18.920 kcal/h

8.192,00
245 / 1,53

TP-1110G
032J1050

TUTTA PIASTRA GAS PASSANTE SU MOBILE A GIORNO PIASTRA CM 73X79 (INCLUSA 1 TESTATA CHIUSURA PIANO MOD.TPA-11)

EN Pass-through gas Solid top on open unit - Plate 73x79 cm (included 1 Head end filler strip mod.TPA-11) • **DE** Durchgehende Gas-Kochplatte mit offenem Unterbau - Platte 73x79 cm (inbegriffen 1 Abschluss-Element mod.TPA-11) • **FR** Toute plaque gaz traversant sur meuble ouvert - Plaque cm 73x79 (inclus 1 Élément de jonction top mod.TPA-11) • **ES** Placa de cocción gas pasante sobre mueble abierto - Placa cm 73x79 (incluida 1 Chapa de cierre para top mod.TPA-11)
cm. 100x 110x 90h



⚡ 12 kW
10.320 kcal/h

5.801,00
198 / 1,53

TP-118ET
031C0830

TUTTA PIASTRA ELETTRICO PASSANTE SU MOBILE A GIORNO PIASTRA CM. 70X68 - 4 ZONE (INCLUSA 1 TESTATA CHIUSURA PIANO MOD.TPA-11)

EN Pass-through Electric Solid top on open unit - Plate cm. 70x68 (included 1 Head end filler strip mod.TPA-11) • **DE** Durchgehende Kochplatten Elektrische mit offenem Unterbau - Platte cm. 70x68 (inbegriffen 1 Abschluss-Element mod.TPA-11) • **FR** Toute plaque électriques traversant sur meuble ouvert - Plaque cm. 70x68 (inclus 1 Élément de jonction top mod.TPA-11) • **ES** Placa de cocción electrica pasante sobre mueble abierto - Placa cm. 70x68 (incluida 1 Chapa de cierre para top mod.TPA-11)
cm. 80x 110x 90h



⚡ 13,6 kW
400V~3N
50/60 Hz

6.736,00
153 / 1,15

CP-558G
03270850

CUOCIPASTA GAS. VASCA 40 LITRI CM. 51X30,7X32,7H. RUBINETTO CARICO ACQUA, SFIORATORE + SCARICO A PAVIMENTO. (CESTI ESCLUSI) (INCLUSA 1 TESTATA CHIUSURA PIANO MOD.TPA-55)

EN Gas pasta cooker 40 lts. Tank cm. 51x30,7x32,7h. Water loading cock + overflow device and floor draining (BASKETS EXCLUDED) (included 1 Head end filler strip mod.TPA-55) • **DE** Gas-Nudelkocher lt. 40. Becken cm. 51x30,7x32,7h. Wasserlauf-Hahn, + Überlauf-Vorrichtung und Ablauf am Boden (KORB AUSGESCHLOSSEN) (inbegriffen 1 Abschluss-Element mod.TPA-55) • **FR** Cuiseur à pates gaz lt. 40. Cuve cm.51x30,7x32,7h. Robinet d'arrivée d'eau trop plein + système de vidange au sol (PANIERS EXCLUS) (inclus 1 Élément de jonction top mod.TPA-55) • **ES** Cuece pasta gas 40 lt. Cuba cm. 51x30,7x32,7h. Grifo carga agua + vertedero + descarga a pavimento (CESTAS EXCLUIDAS) (incluida 1 Chapa de cierre para top mod.TPA-55)
cm. 80x 55x 90h



⚡ 13,95 kW
11.997 kcal/h

4.265,00
84 / 0,62

⚡ 0,02 kW
230V~
50/60 Hz

COMBINAZIONI

- Combinations / • Zusammenstellungen
- Combinaisons / • Combinación múltiple



CUOCIPASTA A GAS

MOD. _____
COD. _____

DESCRIZIONE / DESCRIPTION / BEZEICHNUNG / DESCRIPTION / DESCRIPCIÓN
DIMENSIONI / DIMENSIONS / ABMESSUNGEN / DIMENSIONS / DIMENSIONES

POTENZA / POWER / LEISTUNG / PUISSANCE / POTENCIA
VOLTAGGIO / VOLTAGE / SPANNUNG / VOLTAGE / VOLTAJE

⚡ kW kcal/h
⚡ kW V~ Hz

PREZZO / PRICE
PREIS / PRIX / PRECIO
KG / M³



CPA-558G
03270855

CUOCIPASTA GAS. VASCA 40 LITRI CM. 51X30,7X32,7H. CARICO ACQUA AUTOMATICO CON SENSORE DI LIVELLO - SFIORATORE + SCARICO A PAVIMENTO (CESTI ESCLUSI) (INCLUSA 1 TESTATA CHIUSURA PIANO MOD.TPA-55)

EN Gas pasta cooker 40 lts. Tank cm. 51x30,7x32,7h. Automatic Water loading with level sensor - overflow device and floor draining (BASKETS EXCLUDED) (included 1 Head end filler strip mod.TPA-55) • **DE** Gas-Nudelkocher lt. 40. Becken cm. 51x30,7x32,7h. Automatische Wasser Beladung mit Niveauregulierung + Überlauf-Vorrichtung und Ablauf am Boden (KORB AUSGESCHLOSSEN) (inbegriffen 1 Abschluss-Element mod.TPA-55) • **FR** Cuiseur à pates gaz lt. 40. Cuve cm.51x30,7x32,7h. Chargement automatique de l'eau avec sensor de niveau, trop plein système de vidange au sol (PANIERS EXCLUS) (inclus 1 Élément de jonction top mod.TPA-55) • **ES** Cuece pasta gas 40 lt. Cuba cm. 51x30,7x32,7h. Carga automática de agua con sensor de nivel + vertedero + descarga a pavimento. (CESTAS EXCLUIDAS) (incluida 1 Chapa de cierre para top mod.TPA-55)
cm. 80x 55x 90h



⚡ 13,95 kW
11.997 kcal/h **4.592,00**
84 / 0,62

⚡ 0,035 KW
230V~
50/60 Hz

COMBINAZIONI

- Combinations / • Zusammenstellungen
- Combinaisons / • Combinación múltiple



CP-558ET
03100830

CUOCIPASTA ELETTRICO. VASCA 40 LITRI CM. 51X30,7X32,7H. RUBINETTO CARICO ACQUA, SFIORATORE + SCARICO A PAVIMENTO. (CESTI ESCLUSI) (INCLUSA 1 TESTATA CHIUSURA PIANO MOD.TPA-55)

EN Electric Pasta cooker 40 lts Tank cm. 51x30,7x32,7h. Water loading cock + overflow device and floor draining (BASKETS EXCLUDED) (included 1 Head end filler strip mod.TPA-55) • **DE** Nudelkocher Elektrische lt. 40. Becken cm. 51x30,7x32,7h. Wasserlauf-Hahn, + Überlauf-Vorrichtung und Ablauf am Boden (KORB AUSGESCHLOSSEN) (inbegriffen 1 Abschluss-Element mod.TPA-55) • **FR** Cuiseur à pates électriques lt. 40. Cuve cm.51x30,7x32,7h. Robinet d'arrivée d'eau trop plein + système de vidange au sol (PANIERS EXCLUS) (inclus 1 Élément de jonction top mod.TPA-55) • **ES** Cuece pasta eléctrico 40 lt. Cuba cm. 51x30,7x32,7h. Grifo carga agua + vertedero + descarga a pavimento (CESTAS EXCLUIDAS) (incluida 1 Chapa de cierre para top mod.TPA-55)
cm. 80x 55x 90h



⚡ 13,5 kW **4.138,00**
400V~3N 72 / 0,62
50/60 Hz

COMBINAZIONI

- Combinations / • Zusammenstellungen
- Combinaisons / • Combinación múltiple



MOD. _____
COD. _____

DESCRIZIONE/DESCRIPTION/BEZEICHNUNG/DESCRIPTION/DESCRIPCIÓN
DIMENSIONI/DIMENSIONS/ABMESSUNGEN/DIMENSIONS/DIMENSIONES

POTENZA/POWER/LEISTUNG/PUISSANCE/POTENCIA
VOLTAGGIO/VOLTAGE/SPANNUNG/VOLTAGE/VOLTAJE

⚡ kW _____
kcal/h _____
V~ _____
Hz _____

PREZZO/PRICE
PREIS/PRIX/PRECIO
KG / M³



CPA-558ET
03100835

CUOCIPASTA ELETTRICO. VASCA 40 LITRI CM. 51X30,7X32,7H. CARICO ACQUA AUTOMATICO CON SENSORE DI LIVELLO - SFIORATORE + SCARICO A PAVIMENTO (CESTI ESCLUSI) (INCLUSA 1 TESTATA CHIUSURA PIANO MOD.TPA-55)

EN Electric Pasta cooker 40 lts Tank cm. 51x30,7x32,7h. Automatic Water loading with level sensor - overflow device and floor draining (BASKETS EXCLUDED) (included 1 Head end filler strip mod.TPA-55) • **DE** Nudelkocher Elektrische lt. 40. Becken cm. 51x30,7x32,7h. Automatische Wasser Beladung mit Niveauregulierung + Überlauf-Vorrichtung und Ablauf am Boden (KORB AUSGESCHLOSSEN) (inbegriffen 1 Abschluss-Element mod.TPA-55) • **FR** Cuiseur à pâtes électriques lt. 40. Cuve cm.51x30,7x32,7h. Chargement automatique de l'eau avec sensor de niveau, trop plein Système de vidange au sol (PANIERS EXCLUS) (inclus 1 Élément de jonction top mod.TPA-55) • **ES** Cucece pasta eléctrico 40 lt. Cuba cm. 51x30,7x32,7h. Carga automática de agua con sensor de nivel + vertedero + descarga a pavimento. (CESTAS EXCLUIDAS) (incluida 1 Chapa de cierre para top mod.TPA-55)
cm. 80x 55x 90h



⚡ 13,5 kW _____ **4.592,00**
400V~3N _____ 72 / 0,62
50/60 Hz _____

COMBINAZIONI

- Combinations / • Zusammenstellungen
- Combinaisons / • Combinación múltiple



BM-114EM
030F0410

BAGNOMARIA ELETTRICO PASSANTE SU MOBILE A GIORNO VASCA PER GN-1/1 + GN-1/3 CM.15H. RUBINETTO CARICO ACQUA, SCARICO A PAVIMENTO (INCLUSA 1 TESTATA CHIUSURA PIANO MOD.TPA-11)

EN Pass-through Electric Bain-marie on open cabinet - Bowl for GN-1/1 + GN-1/3 cm.15h. Water loading tap floor draining (included 1 Head end filler strip mod.TPA-11) • **DE** Durchgehende Wasserbäder elektrische mit Offenem Unterbau - Becken für GN-1/1 + GN-1/3 cm.15h.Wasserlauf-Hahn, Ablauf am Boden (inbegriffen 1 Abschluss-Element mod.TPA-11) • **FR** Bain marie électriques traversant sur armoire ouvert. Cuve pour GN-1/1 + GN-1/3 cm.15h. Robinet d'arrivée d'eau - Système de vidange au sol (inclus 1 Élément de jonction top mod.TPA-11) • **ES** Baño de maría eléctrico pasante sobre mueble abierto, Cuba para GN-1/1 + GN-1/3 cm.15h. Grifo carga agua, descarga a pavimento (incluida 1 Chapa de cierre para top mod.TPA-11)
cm. 40x 110x 90h



⚡ 2,85 kW _____ **2.702,00**
230V~ _____ 63 / 0,58
50/60 Hz _____

FTL-1110GS
032D1054

FRY-TOP GAS PASSANTE LISCIO CROMATO SUPERCHROME (MOCA APPROVED), SU MOBILE A GIORNO, PIASTRA CM.76X85 - 2 ZONE DI COTTURA (INCLUSA 1 TESTATA CHIUSURA PIANO MOD.TPA-11)

EN Pass-through gas Fry-top smooth chromed griddle SUPERCHROME (Moca Approved), on open cabinet, plate cm.76x85 - 2 cooking areas (included 1 Head end filler strip mod.TPA-11) • **DE** Durchgehende Gas-griddleplatte glatt hartverchromt SUPERCHROME (Moca Approved), mit offenem Unterbau, platte cm.76x85 - 2 Heizzonen (inbegriffen 1 Abschluss-Element mod.TPA-11) • **FR** Plaque gaz traversant lisse chromée SUPERCHROME (Moca Approved), sur armoire ouvert, plaque cm.76x85 - 2 zones de cuisson (inclus 1 Élément de jonction top mod.TPA-11) • **ES** Fry-top gas pasante liso cromado SUPERCHROME (Moca Approved), sobre mueble abierto, plancha cm.76x85 - 2 zonas de cocción (incluida 1 Chapa de cierre para top mod.TPA-11)
cm. 100x 110x 90h



⚡ 24 kW _____ **5.860,00**
20.640 kcal/h _____ 190 / 1,53

MOD. _____
COD. _____

DESCRIZIONE/DESCRIPTION/BEZEICHNUNG/DESCRIPTION/DESCRIPCIÓN
DIMENSIONI/DIMENSIONS/ABMESSUNGEN/DIMENSIONS/DIMENSIONES

POTENZA/POWER/LEISTUNG/PUISSANCE/POTENCIA
VOLTAGGIO/VOLTAGE/SPANNUNG/VOLTAGE/VOLTAJE

⚡ kW
kcal/h

PREZZO/PRICE
PREIS/PRIX/PRECIO
KG / M³



FTLR-1110GS FRY-TOP GAS PASSANTE 1/2 RIGATO + 1/2 LISCIO CROMATO SUPERCHROME (MOCA APPROVED), SU MOBILE A GIORNO, PIASTRA CM.76X85 - 2 ZONE DI COTTURA (INCLUSA 1 TESTATA CHIUSURA PIANO MOD.TPA-11)

032D1055

EN Pass-through gas Fry-top 1/2 grooved + 1/2 smooth chromed griddle SUPERCHROME (Moca Approved), on open cabinet, plate cm.76x85 - 2 cooking areas (included 1 Head end filler strip mod. TPA-11) • **DE** Durchgehende Gas-griddleplatte 1/2 gerillt + 1/2 glatt hartverchromt SUPERCHROME (Moca Approved), mit offenem Unterbau, platte cm.76x85 - 2 Heizzonen (inbegriffen 1 Abschluss-Element mod. TPA-11) • **FR** Plaque gaz traversant 1/2 nervurée + 1/2 lisse chromée SUPERCHROME (Moca Approved), sur armoire ouvert, plaque cm.76x85 - 2 zones de cuisson (inclus 1 Élément de jonction top mod.TPA-11) • **ES** Fry-top gas pasante 1/2 estriado + 1/2 liso cromado SUPERCHROME (Moca Approved), sobre mueble abierto, plancha cm.76x85 - 2 zonas de cocción (incluida 1 Chapa de cierre para top mod.TPA-11)
cm. 100x 110x 90h



⚡ 24 kW
20.640 kcal/h

6.133,00
190 / 1,53



FTL-558GS FRY-TOP GAS LISCIO CROMATO SUPERCHROME (MOCA APPROVED), SU MOBILE A GIORNO, PIASTRA CM.76X34 - 2 ZONE DI COTTURA (INCLUSA 1 TESTATA CHIUSURA PIANO MOD.TPA-55)

03230854

EN Gas Fry-top smooth chromed griddle SUPERCHROME (Moca Approved), on open cabinet, plate cm.76x34 - 2 cooking areas (included 1 Head end filler strip mod.TPA-55) • **DE** Gas-griddleplatte glatt hartverchromt SUPERCHROME (Moca Approved), mit offenem Unterbau, platte cm.76x34 - 2 Heizzonen (inbegriffen 1 Abschluss-Element mod.TPA-55) • **FR** Plaque gaz lisse chromée SUPERCHROME (Moca Approved), sur armoire ouvert, plaque cm.76x34 - 2 zones de cuisson (inclus 1 Élément de jonction top mod.TPA-55) • **ES** Fry-top gas liso cromado SUPERCHROME (Moca Approved), sobre mueble abierto, plancha cm.76x34 - 2 zonas de cocción (incluida 1 Chapa de cierre para top mod.TPA-55)
cm. 80x 55x 90h



⚡ 10 kW
8.600 kcal/h

3.600,00
96 / 0,62

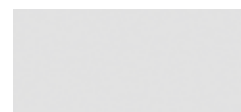

FTLR-558GS FRY-TOP GAS 1/2 RIGATO + 1/2 LISCIO CROMATO SUPERCHROME (MOCA APPROVED), SU MOBILE A GIORNO, PIASTRA CM.76X34 - 2 ZONE DI COTTURA (INCLUSA 1 TESTATA CHIUSURA PIANO MOD.TPA-55)

03230855

EN Gas Fry-top 1/2 grooved + 1/2 smooth chromed griddle SUPERCHROME (Moca Approved), on open cabinet, plate cm.76x34 - 2 cooking areas (included 1 Head end filler strip mod.TPA-55) • **DE** Gas-griddleplatte 1/2 gerillt + 1/2 glatt hartverchromt SUPERCHROME (Moca Approved), mit offenem Unterbau, platte cm.76x34 - 2 Heizzonen (inbegriffen 1 Abschluss-Element mod.TPA-55) • **FR** Plaque gaz 1/2 nervurée + 1/2 lisse chromée SUPERCHROME (Moca Approved), sur armoire ouvert, plaque cm.76x34 - 2 zones de cuisson (inclus 1 Élément de jonction top mod.TPA-55) • **ES** Fry-top gas 1/2 estriado + 1/2 liso cromado SUPERCHROME (Moca Approved), sobre mueble abierto, plancha cm.76x34 - 2 zonas de cocción (incluida 1 Chapa de cierre para top mod.TPA-55)
cm. 80x 55x 90h



⚡ 10 kW
8.600 kcal/h

3.799,00
96 / 0,62



FTL-118ETS FRY-TOP ELETTRICO PASSANTE LISCIO CROMATO SUPERCHROME (MOCA APPROVED), SU MOBILE A GIORNO, PIASTRA CM.76X85 - 2 ZONE DI COTTURA (INCLUSA 1 TESTATA CHIUSURA PIANO MOD.TPA-11)

030G0834

EN Pass-through Electric Fry-top smooth chromed griddle SUPERCHROME (Moca Approved), on open cabinet, plate cm.76x85 - 2 cooking areas (included 1 Head end filler strip mod.TPA-11) • **DE** Durchgehende Griddleplatte elektrische glatt hartverchromt SUPERCHROME (Moca Approved), mit offenem Unterbau, platte cm.76x85 - 2 Heizzonen (inbegriffen 1 Abschluss-Element mod.TPA-11) • **FR** Plaque électriques traversant lisse chromée SUPERCHROME (Moca Approved), sur armoire ouvert, plaque cm.76x85 - 2 zones de cuisson (inclus 1 Élément de jonction top mod.TPA-11) • **ES** Fry-top eléctrico pasante liso cromado SUPERCHROME (Moca Approved), sobre mueble abierto, plancha cm.76x85 - 2 zonas de cocción (incluida 1 Chapa de cierre para top mod.TPA-11)
cm. 80x 110x 90h



⚡ 17 kW
400V~3N

5.349,00
160 / 1,15



MOD. _____
COD. _____

DESCRIZIONE / DESCRIPTION / BEZEICHNUNG / DESCRIPTION / DESCRIPCIÓN
DIMENSIONI / DIMENSIONS / ABMESSUNGEN / DIMENSIONS / DIMENSIONES

POTENZA / POWER / LEISTUNG / PUISSANCE / POTENCIA
VOLTAGGIO / VOLTAGE / SPANNUNG / VOLTAGE / VOLTAJE

⚡ kW kcal/h
⚡ kw V~ Hz

PREZZO / PRICE
PREIS / PRIX / PRECIO
KG / M³



FTLR-118ETS FRY-TOP ELETTRICO PASSANTE 1/2 RIGATO + 1/2 LISCIO CROMATO SUPERCHROME (MOCA APPROVED), SU MOBILE A GIORNO, PIASTRA CM.76X85 - 2 ZONE DI COTTURA (INCLUSA 1 TESTATA CHIUSURA PIANO MOD.TPA-11)
030G0835

EN Pass-through Electric Fry-top 1/2 grooved + 1/2 smooth chromed griddle SUPERCHROME (Moca Approved), on open cabinet, plate cm.76x85 - 2 cooking areas (included 1 Head end filler strip mod.TPA-11)
 • **DE** Durchgehende Griddleplatte elektrische 1/2 gerillt + 1/2 glatt hartverchromt SUPERCHROME (Moca Approved), mit offenem Unterbau, platte cm.76x85 - 2 Heizzonen (inbegriffen 1 Abschluss-Element mod. TPA-11)
 • **FR** Plaque électriques traversant 1/2 nervurée + 1/2 lisse chromée SUPERCHROME (Moca Approved), sur armoire ouvert, plaque cm.76x85 - 2 zones de cuisson (inclus 1 Élément de jonction top mod. TPA-11)
 • **ES** Fry-top eléctrico pasante 1/2 estriado + 1/2 liso cromado SUPERCHROME (Moca Approved), sobre mueble abierto, plancha cm.76x85 - 2 zonas de cocción (incluida 1 Chapa de cierre para top mod.TPA-11)
cm. 80x 110x 90h



⚡ 17 kW 5.611,00
400V~3N 160 / 1,15



FTL-558ETS FRY-TOP ELETTRICO LISCIO CROMATO SUPERCHROME (MOCA APPROVED), SU MOBILE A GIORNO, PIASTRA CM.76X34 - 2 ZONE DI COTTURA (INCLUSA 1 TESTATA CHIUSURA PIANO MOD.TPA-55)
03060834

EN Electric Fry-top smooth chromed griddle SUPERCHROME (Moca Approved), on open cabinet, plate cm.76x34 - 2 cooking areas (included 1 Head end filler strip mod.TPA-55)
 • **DE** Griddleplatte elektrische glatt hartverchromt SUPERCHROME (Moca Approved), mit offenem Unterbau, platte cm.76x34 - 2 Heizzonen (inbegriffen 1 Abschluss-Element mod. TPA-55)
 • **FR** Plaque électriques lisse chromée SUPERCHROME (Moca Approved), sur armoire ouvert, plaque cm.76x34 - 2 zones de cuisson (inclus 1 Élément de jonction top mod.TPA-55)
 • **ES** Fry-top eléctrico liso cromado SUPERCHROME (Moca Approved), sobre mueble abierto, plancha cm.76x34 - 2 zonas de cocción (incluida 1 Chapa de cierre para top mod.TPA-55)
cm. 80x 55x 90h



⚡ 6,6 kW 3.590,00
400V~2N 84 / 0,62
230V~3
230V~

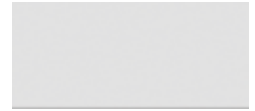

FTLR-558ETS FRY-TOP ELETTRICO 1/2 RIGATO + 1/2 LISCIO CROMATO SUPERCHROME (MOCA APPROVED), SU MOBILE A GIORNO, PIASTRA CM.76X34 - 2 ZONE DI COTTURA (INCLUSA 1 TESTATA CHIUSURA PIANO MOD.TPA-55)
03060835

EN Electric Fry-top 1/2 grooved + 1/2 smooth chromed griddle SUPERCHROME (Moca Approved), on open cabinet, plate cm.76x34 - 2 cooking areas (included 1 Head end filler strip mod.TPA-55)
 • **DE** Griddleplatte elektrische 1/2 gerillt + 1/2 glatt hartverchromt SUPERCHROME (Moca Approved), mit offenem Unterbau, platte cm.76x34 - 2 Heizzonen (inbegriffen 1 Abschluss-Element mod. TPA-55)
 • **FR** Plaque électriques 1/2 nervurée + 1/2 lisse chromée SUPERCHROME (Moca Approved), sur armoire ouvert, plaque cm.76x34 - 2 zones de cuisson (inclus 1 Élément de jonction top mod.TPA-55)
 • **ES** Fry-top eléctrico 1/2 estriado + 1/2 liso cromado SUPERCHROME (Moca Approved), sobre mueble abierto, plancha cm.76x34 - 2 zonas de cocción (incluida 1 Chapa de cierre para top mod.TPA-55)
cm. 80x 55x 90h



⚡ 6,6 kW 3.816,00
400V~2N 84 / 0,62
230V~3
230V~



CW-114G GRIGLIA GAS-PIETRALAVICA PASSANTE SU MOBILE A GIORNO GRIGLIA IN ACCIAIO INOX CM. 38X52 REGOLABILE (INCLUSA 1 TESTATA CHIUSURA PIANO MOD.TPA-11)
032F0450

EN Pass-through Charcoal grill gas on open cabinet Stainless steel grill cm. 38x52 (included 1 Head end filler strip mod.TPA-11)
 • **DE** Durchgehende Gas-Lavasteingrill mit offenem Unterbau Einstellbarer Rost aus Nirosta cm. 38x52 (inbegriffen 1 Abschluss-Element mod.TPA-11)
 • **FR** Grille à gaz en pierre de lave traversant sur armoire ouvert Grille inox cm 38x52 (inclus 1 Élément de jonction top mod.TPA-11)
 • **ES** Parrilla a gas piedra lávica pasante sobre mueble abierto Parrilla de acero inox regulable cm 38x52 (incluida 1 Chapa de cierre para top mod. TPA-11)
cm. 40x 110x 90h



⚡ 9 kW 2.935,00
7.740 kcal/h 83 / 0,58

GRIGLIE ELETTRICHE

MOD. _____
COD. _____

DESCRIZIONE/DESCRIPTION/BEZEICHNUNG/DESCRIPTION/DESCRIPCIÓN
DIMENSIONI/DIMENSIONS/ABMESSUNGEN/DIMENSIONS/DIMENSIONES

POTENZA/POWER/LEISTUNG/PUISSANCE/POTENCIA
VOLTAGGIO/VOLTAGE/SPANNUNG/VOLTAGE/VOLTAJE

⚡ kW
kcal/h

⚡ kW
V~
Hz

PREZZO/PRICE
PREIS/PRIX/PRECIO
KG / M³



CWK-114ET GRIGLIA CONTACT PASSANTE SU MOBILE A GIORNO -
03010431 **COTTURA DIRETTA SU RESISTENZA IN ACCIAIO INOX CM.
27X43 RIBALTABILE (INCLUSA 1 TESTATA CHIUSURA PIANO
MOD.TPA-11)**

EN Pass-through Electric contact Grill on open cabinet - rotatable stainless steel grill cm. 27x43 (included 1 Head end filler strip mod.TPA-11) • **DE** Durchgehende Elektrische Wurstbrater KONTAKT mit offenem Unterbau - Drehbaren Heizelement aus Edelstahl cm. 27x43 (inbegriffen 1 Abschluss-Element mod.TPA-11) • **FR** Grillade électrique CONTACT traversant sur armoire ouvert- Grille inox rotatif cm 27x43 (inclus 1 Élément de jonction top mod.TPA-11) • **ES** Parrilla eléctrica CONTACT pasante sobre mueble abierto - Parrilla giratoria de acero inox cm 27x43 (incluida 1 Chapa de cierre para top mod.TPA-11)
cm. 40x 110x 90h



⚡ 4,08 kW
400V~3N
50/60 Hz

3.627,00
83 / 0,58

F13-554G FRIGGITRICE GAS 13 LITRI, VASCA CM. 32,5X31,5X36H - 1
03260450 **CESTO CM. 30X27,5X12H - FILTRO E COPERCHIO VASCA.
BACINELLA RACCOGLIOLIO CON FILTRO. - PRODUZIONE
PATATE: 10 KG/H**

EN Gas fryer 13 lts - Bowl cm. 32,5x31,5x36h - 1 basket cm. 30x27,5x12h. Sieve and lid for pan. - Drip tray with sieve. Production: 10 kg/h • **DE** Gas-Friteuse lt. 13 - Becken cm. 32,5x31,5x36h - 1 Korb cm. 30x27,5x12h. Einlegesieb und Deckel für Becken. - Fettauffangschale mit Sieb. Pommes frites: 10 kg/h • **FR** Friteuse a gaz lt. 13 - Cuve cm. 32,5x31,5x36h - 1 Panier cm. 30x27,5x12h. Filtre, couvercle pour cuve. - Bac de récupération de l'huile avec filtre. Production de pommes frites: 10 kg/h • **ES** Freidora a gas 13 lt. - Cuba cm. 32,5x31,5x36h - 1 cesta cm. 30x27,5x12h. Filtro y tapa para cuba. Bandeja recoge aceite con filtro. Prod. patatas: 10 Kg/h
cm. 40x 55x 90h



⚡ 10,5 kW
9.030 kcal/h

2.808,00
60 / 0,37

F13-554ET FRIGGITRICE ELETTRICA 13 LITRI, VASCA CM. 24X35X32H
03090430 **- 1 CESTO CM. 21X30X12H - FILTRO E COPERCHIO VASCA.
BACINELLA RACCOGLIOLIO CON FILTRO. - PRODUZIONE
PATATE: 10 KG/H**

EN Electric Fryer 13 lts - Bowl cm. 24x35x32h - 1 basket cm. 21x30x12h. Sieve and lid for pan. - Drip tray with sieve. Production: 10 kg/h • **DE** Elektrische Friteuse lt. 13 - Becken cm. 24x35x32h - 1 Korb cm. 21x30x12h. Einlegesieb und Deckel für Becken. - Fettauffangschale mit Sieb. Pommes frites: 10 kg/h • **FR** Friteuse électrique lt. 13 - Cuve cm. 24x35x32h - 1 Panier cm. 21x30x12h. Filtre, couvercle pour cuve. - Bac de récupération de l'huile avec filtre. Production de pommes frites: 10 kg/h • **ES** Freidora eléctrica 13 lt. - Cuba cm. 24x35x32h - 1 cesta cm. 21x30x12h. Filtro y tapa para cuba. Bandeja recoge aceite con filtro. Prod. patatas: 10 Kg/h
cm. 40x 55x 90h



⚡ 10,95 kW
400V~3N
50/60 Hz

2.597,00
52 / 0,37

BRF-558ET BRASIERA FISSA MULTIFUNZIONALE ELETTRICA, VASCA CM.
03070833 **68X30X10H (INCLUSA 1 TESTATA CHIUSURA PIANO MOD.
TPA-55)**

EN Electric Multi-function fixed braising pan bowl cm. 68x30x10h (included 1 Head end filler strip mod.TPA-55) • **DE** Multifunktionsbratpfanne fest becken cm. 68x30x10h (inbegriffen 1 Abschluss-Element mod.TPA-55) • **FR** Sauteuse fixe multifonction cuve cm. 68x30x10h (inclus 1 Élément de jonction top mod.TPA-55) • **ES** Sartén fija multifunción cuba cm. 68x30x10h (incluida 1 Chapa de cierre para top mod.TPA-55)
cm. 80x 55x 90h



⚡ 5,2 kW
400V~2N
50/60 Hz

4.677,00
80 / 0,62

PL-112 PIANO LAVORO PASSANTE SU MOBILE (INCLUSA 1 TESTATA
030B0200 **CHIUSURA PIANO MOD.TPA-11)**

EN Pass-through worktop on cabinet (included 1 Head end filler strip mod.TPA-11) • **DE** Durchgehende Arbeitsplatte mit Unterbau (inbegriffen 1 Abschluss-Element mod.TPA-11) • **FR** Plan de travail traversant sur armoire (inclus 1 Élément de jonction top mod.TPA-11) • **ES** Sobre de trabajo pasante sobre mueble (incluida 1 Chapa de cierre para top mod.TPA-11)
cm. 20x 110x 90h



1.404,00
40 / 0,58

MOD. _____
COD. _____

DESCRIZIONE/DESCRIPTION/BEZEICHNUNG/DESCRIPTION/DESCRIPCIÓN
DIMENSIONI/DIMENSIONS/ABMESSUNGEN/DIMENSIONS/DIMENSIONES

POTENZA/POWER/LEISTUNG/PUISSANCE/POTENCIA
VOLTAGGIO/VOLTAGE/SPANNUNG/VOLTAGE/VOLTAJE

⚡ kW kcal/h
⚡ kW V~ Hz

PREZZO/PRICE
PREIS/PRIX/PRECIO
KG / M³



PL-114
030B0400

PIANO LAVORO PASSANTE SU MOBILE A GIORNO, 2 CASSETTI CON 2 BACINELLE GN-2/3 CM.15H INOX (INCLUSA 1 TESTATA CHIUSURA PIANO MOD.TPA-11)

EN Pass-through worktop on open cabinet, 2 drawers with 2 GN-2/3 cm.15h inox containers. (included 1 Head end filler strip mod.TPA-11)
• DE Durchgehende Arbeitsplatte mit offenem Unterbau, 2 Schubladen mit 2 GN-2/3 cm.15h Behälter aus Edelstahl. (inbegriffen 1 Abschluss-Element mod.TPA-11) **• FR** Plan de travail traversant sur armoire ouvert, 2 tiroirs avec 2 bacs GN-2/3 cm.15h inox. (inclus 1 Élément de jonction top mod.TPA-11) **• ES** Sobre de trabajo pasante sobre mueble abierto, 2 cajones con 2 contenedores GN-2/3 cm.15h de acero inox. (incluida 1 Chapa de cierre para top mod.TPA-11)
cm. 40x 110x 90h



2.270,00
70 / 0,58

PL-554
03010400

PIANO LAVORO SU MOBILE A GIORNO, CASSETTO CON 1 BACINELLA GN-2/3 CM.15H INOX (INCLUSA 1 TESTATA CHIUSURA PIANO MOD.TPA-55)

EN Worktop on open cabinet, Drawer with 1 container GN-2/3 cm.15h inox. (included 1 Head end filler strip mod.TPA-55) **• DE** Arbeitsplatte mit offenem Unterbau, schublade mit 1 GN-2/3 cm.15h Behälter aus Edelstahl. (inbegriffen 1 Abschluss-Element mod.TPA-55) **• FR** Plan de travail sur armoire ouvert, tiroir avec 1 bac GN-2/3 cm.15h inox. (inclus 1 Élément de jonction top mod.TPA-55) **• ES** Sobre de trabajo sobre mueble abierto, cajón con 1 contenedor GN-2/3 cm.15h de acero inox (incluida 1 Chapa de cierre para top mod.TPA-55)
cm. 40x 55x 90h



1.161,00
40 / 0,37

PL-558
03010800

PIANO LAVORO SU MOBILE A GIORNO, CASSETTO CON 1 BACINELLA GN-1/1 E 1 BACINELLA GN-1/3 CM.15H INOX (INCLUSA 1 TESTATA CHIUSURA PIANO MOD.TPA-55)

EN Worktop on open cabinet, Drawer with 1 container GN-1/1 and 1 GN-1/3 cm.15h inox. (included 1 Head end filler strip mod.TPA-55)
• DE Arbeitsplatte mit offenem Unterbau, schublade mit 1 GN-1/1 und 1 GN-1/3 cm.15h Behälter aus Edelstahl. (inbegriffen 1 Abschluss-Element mod.TPA-55) **• FR** Plan de travail sur armoire ouvert, tiroir avec 1 bac GN-1/1 et 1 GN-1/3 cm.15h inox. (inclus 1 Élément de jonction top mod.TPA-55) **• ES** Sobre de trabajo sobre mueble abierto, cajón con 1 contenedor GN-1/1 y 1 GN-1/3 cm.15h de acero inox (incluida 1 Chapa de cierre para top mod.TPA-55)
cm. 80x 55x 90h



1.795,00
65 / 0,62

P-73/93-DX
08430300

PORTA 300 DESTRA

EN Right door 300 **• DE** Rechte tür 300 **• FR** Porte droite 300 **• ES** Puerta derecha 300
cm. 29,5x 2,5x 47,5h



197,00
3 / 0,01

P-74/94-DX
08430400

PORTA 400 DESTRA

EN Right door 400 **• DE** Rechte tür 400 **• FR** Porte droite 400 **• ES** Puerta derecha 400
cm. 39,5x 2,5x 47,5h

204,00
3.5 / 0,02

MOD. _____
COD. _____

DESCRIZIONE/DESCRIPTION/BEZEICHNUNG/DESCRIPTION/DESCRIPCIÓN
DIMENSIONI/DIMENSIONS/ABMESSUNGEN/DIMENSIONS/DIMENSIONES

POTENZA/POWER/LEISTUNG/PUISSANCE/POTENCIA
VOLTAGGIO/VOLTAGE/SPANNUNG/VOLTAGE/VOLTAJE

⚡ kW kcal/h
⚡ kW V~ Hz

PREZZO/PRICE
PREIS/PRIX/PRECIO
KG / M³



P-73/93-SX PORTA 300 SINISTRA
08430301 **EN** Left door 300 • **DE** Linke tür 300 • **FR** Porte gauche 300 • **ES**
Puerta izquierda 300
cm. 29,5x 2,5x 47,5h



197,00
3 / 0,01

P-74/94-SX PORTA 400 SINISTRA
08430401 **EN** Left door 400 • **DE** Linke tür 400 • **FR** Porte gauche 400 • **ES**
Puerta izquierda 400
cm. 39,5x 2,5x 47,5h

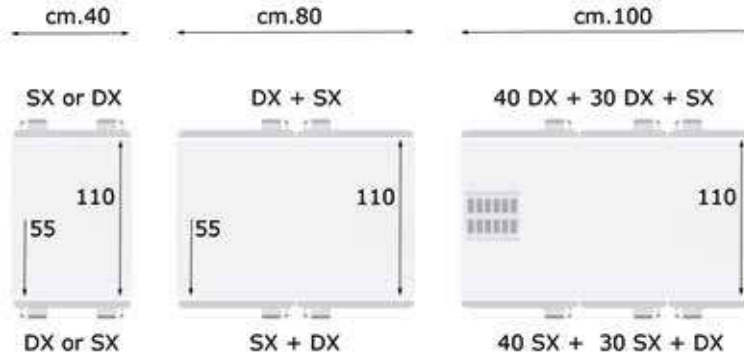

204,00
3.5 / 0,02

C-554
03440420 **CASSETTIERA CM.40 - N. 2 CASSETTI CON 2 BACINELLE GN-2/3 CM.15H, GUIDE TELESCOPICHE. (NO PER BM-114E)**
EN Drawer set cm.40 - N. 2 drawers with 2 GN-2/3 cm.15h inox containers, telescopic guides. (no for BM-114E) • **DE** Schubladen cm.40 - N. 2 Schubladen mit 2 GN-2/3 cm.15h Behälter aus Edelstahl, Telescopeinführungen. (nein für BM-114E) • **FR** Tiroirs pour meuble de cm.40 - N. 2 tiroirs avec 2 bacs GN-2/3 cm.15h inox, guides télescopiques. (no pour BM-114E) • **ES** Cajonera cm.40 - N. 2 cajones con 2 contenedores GN-2/3 cm.15h de acero inox, guías telescópicas. (no para BM-114E)
cm. 39,5x 50x 47,5h



723,00
11 / 0,19

C-558
03440820 **CASSETTIERA CM.80 - N. 2 CASSETTI CON 2 BACINELLE GN-1/1 E 2 BACINELLE GN-1/3 CM.15H, GUIDE TELESCOPICHE. (NO PER PC-118G)**
EN Drawer set cm.80 - N. 2 drawers with 2 GN-1/1 and 2 GN-1/3 cm.15h inox containers, telescopic guides. (no for PC-118G) • **DE** Schubladen cm.80 - N. 2 Schubladen mit 2 GN-1/1 und 2 GN-1/3 cm.15h Behälter aus Edelstahl, Telescopeinführungen. (nein für PC-118G) • **FR** Tiroirs pour meuble de cm.80 - N. 2 tiroirs avec 2 bacs GN-1/1 et 2 GN-1/3 cm.15h inox, guides télescopiques. (no pour PC-118G) • **ES** Cajonera cm.80 - N. 2 cajones con 2 contenedores GN-1/1 y 2 GN-1/3 cm.15h de acero inox, guías telescópicas. (no para PC-118G)
cm. 79,5x 50x 47,5h



995,00
19 / 0,37

D-11
034H0000 **DIVISORIO DOPPIO**
EN Double Spacer • **DE** Doppelt Trennwand • **FR** Separation Double
• **ES** Divisorio Doble
cm. 5x 101x 42h



301,00
4 / 0,03

MOD.
COD.

DESCRIZIONE/DESCRIPTION/BEZEICHNUNG/DESCRIPTION/DESCRIPCIÓN
DIMENSIONI/DIMENSIONS/ABMESSUNGEN/DIMENSIONS/DIMENSIONES

POTENZA/POWER/LEISTUNG/PUISSANCE/POTENCIA
VOLTAGGIO/VOLTAGE/SPANNUNG/VOLTAGE/VOLTAJE

↓ kW kcal/h
↕ kw V~ Hz

PREZZO/PRICE
PREIS/PRIX/PRECIO
KG / M³



D-55
034F0000

DIVISORIO
EN Spacer • **DE** Trennwand • **FR** Separation • **ES** Divisorio
cm. 5x 47x 42h

153,00
2 / 0,02



R-114
034F0400

RIPIANO (NO PER BM-114E)
EN Shelf (no for BM-114E) • **DE** Zwischenboden (nein für BM-114E)
• **FR** Étagère (no pour BM-114E) • **ES** Estante (no para BM-114E)
cm. 35x100,5x 3,8h

216,00
5 / 0,03



R-118
034F0800

RIPIANO (NO PER PC-118G)
EN Shelf (no for PC-118G) • **DE** Zwischenboden (nein für PC-118G)
• **FR** Étagère (no pour PC-118G) • **ES** Estante (no para PC-118G)
cm. 75x100,5x 3,8h

297,00
10 / 0,06



R-1110
034F1000

RIPIANO
EN Shelf • **DE** Abstellbrett • **FR** Étagère • **ES** Estante
cm. 95x100,5x 3,8h

366,00
12 / 0,07

R-554
03450400

cm. 35x 47x 3,8h

126,00
2,5 / 0,01

R-558
03450800

cm. 75x 47x 3,8h

164,00
5 / 0,03



PT-114
034G0002

PORTATEGLIE 5 LIVELLI INTERASSE 7CM. PER MOBILI PROFONDITÀ CM.110. CAPACITÀ GN1/1+GN2/3 SU CM.40 O 3XGN1/1 SU CM.60
EN Frame for plates 5 shelves, wheel-base cm.7. For appliance with cm.110 deep, capacity GN1/1+GN2/3 on cm.40 or 3xGN1/1 on cm.60 • **DE** Aufhängeschienen für bleche 5 Etagen, Abstand 7 cm. für Möbeltiefe cm.110. Kapazität GN1/1+GN2/3 auf cm.40 oder 3xGN1/1 auf cm.60 • **FR** Kit porte-plaques 5 étagères et empattement cm.7. Pour meuble profondeur cm.110, capacité GN1/1+GN2/3 sur cm.40 ou 3xGN1/1 sur cm.60 • **ES** Portacazuelas 5 estantes con espacio de cm.7. Para equipo de cm.110 de profundidad, capacidad GN1/1+GN2/3 en cm.40 o 3xGN1/1 en cm.60

713,00
5 / 0,02



PT-554
03460002

PORTATEGLIE 5 LIVELLI INTERASSE 7CM. PER MOBILI PROFONDITÀ CM.55. CAPACITÀ GN-2/3 SU CM.40 O GN-1/1 SU CM.60.
EN Frame for plates 5 shelves, wheel-base cm.7. For appliance with cm.55 deep, capacity GN2/3 on cm.40 or GN1/1 on cm.60 • **DE** Aufhängeschienen für bleche 5 Etagen, Abstand 7 cm. für Möbeltiefe cm.55. Kapazität GN2/3 auf cm.40 oder GN1/1 auf cm.60 • **FR** Kit porte-plaques 5 étagères et empattement cm.7. Pour meuble profondeur cm.55, capacité GN2/3 sur cm.40 ou GN1/1 sur cm.60 • **ES** Portacazuelas 5 estantes con espacio de cm.7. Para equipo de cm.55 de profundidad, capacidad GN2/3 en cm.40 o GN1/1 en cm.60

421,00
2.5 / 0,02



ACCESSORI CUOCIPASTA

MOD. _____
COD. _____

DESCRIZIONE/DESCRIPTION/BEZEICHNUNG/DESCRIPTION/DESCRIPCIÓN
DIMENSIONI/DIMENSIONS/ABMESSUNGEN/DIMENSIONS/DIMENSIONES

POTENZA/POWER/LEISTUNG/PUISSANCE/POTENCIA
VOLTAGGIO/VOLTAGE/SPANNUNG/VOLTAGE/VOLTAJE

⚡ kW kcal/h
⚡ kw V~ Hz

PREZZO/PRICE
PREIS/PRIX/PRECIO
KG / M³



531053900 CESTO 1/1 PER CP
EN Basket 1/1 for CP • **DE** Korb 1/1 für CP • **FR** Panier 1/1 pour CP
 • **ES** Cesta 1/1 para CP
cm. 49x 29x 20h

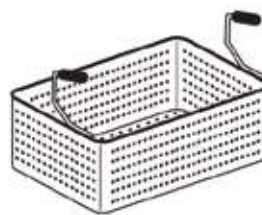

..539..

183,00
3,5 / 0,08

531017900 CESTO 1/3 PER CP
EN Basket 1/3 for CP • **DE** Korb 1/3 für CP • **FR** Panier 1/3 pour CP
 • **ES** Cesta 1/3 para CP
cm. 16x 29x 20h

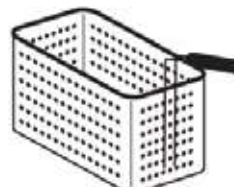

..179..

134,00
1,5 / 0,05

531064300 CESTO 1/4 PER CP
EN Basket 1/4 for CP • **DE** Korb 1/4 für CP • **FR** Panier 1/4 pour CP
 • **ES** Cesta 1/4 para CP
cm. 11,5x 29x 20h

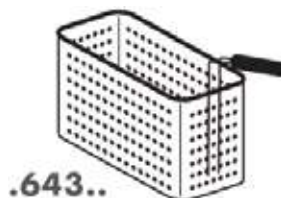

.643..

120,00
1,2 / 0,04

531084100 GRIGLIA IN TONDINO 1 FUOCO S110
EN grid rod 1 burner S110 line • **DE** Gitterstab 1 Brenner S110 • **FR** tige grille 1 feu S110 • **ES** red de varilla 1 quemador S110
cm. 38x 35x 5h



170,00
6 / 0,02

08570401 GRIGLIA TONDINO PER CW-114G
EN Grid for CW-114G • **DE** Gitter für CW-114G • **FR** Grille ronde pour CW-114G • **ES** Rejilla para CW-114G
cm. 36x 51

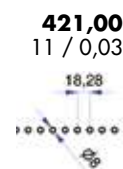

421,00
11 / 0,03

08570402 GRIGLIA TEGOLO V PER CW-114G
EN Grid V for CW-114G • **DE** Gitter V für CW-114G • **FR** Grille V pour CW-114G • **ES** Rejilla V para CW-114G
cm. 36x 51

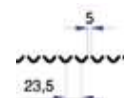

421,00
11 / 0,03

544023800 RASCHIETTO PER PIASTRA RIGATA
EN Scraper for grooved plate • **DE** Schaber für gerillte Kochplatte • **FR** Racloir pour plaque nervurée • **ES** Rasqueta para placa ranurada



64,00
/ 1,00

ACCESSORI FRY-TOP

MOD. _____
COD. _____

DESCRIZIONE/DESCRIPTION/BEZEICHNUNG/DESCRIPTION/DESCRIPCIÓN
DIMENSIONI/DIMENSIONS/ABMESSUNGEN/DIMENSIONS/DIMENSIONES

POTENZA/POWER/LEISTUNG/PUISSANCE/POTENCIA
VOLTAGGIO/VOLTAGE/SPANNUNG/VOLTAGE/VOLTAJE

↓ kW kcal/h
↗ kW V~ Hz

PREZZO/PRICE
PREIS/PRIX/PRECIO
KG / M³



T-FT
09580060

TAPPO PER FRY-TOP
EN stopper for Fry-top • **DE** Stopfen griddleplatte • **FR** bouchon pour Plaque • **ES** tapón Fry-top
cm. 10x 2x 5h



248,00
/ 0,00

531013200 CESTO 1/2 PER F13-554E

EN Basket 1/2 for F13-554E • **DE** Korb 1/2 für F13-554E • **FR** Panier 1/2 pour F13-554E • **ES** Cesta 1/2 para F13-554E
cm. 10x 30x 12h



58,00
0.7 / 0,03

531053300 CESTO 1/2 PER F13-554G

EN Basket 1/2 for F13-554G • **DE** Korb 1/2 für F13-554G • **FR** Panier 1/2 pour F13-554G • **ES** Cesta 1/2 para F13-554G
cm. 15x 27x 12h

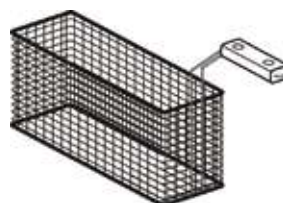

79,00
0.7 / 0,04

09550400

COPERCHIO PER BRF-114
EN Lid for BRF-114 • **DE** Deckel für BRF-114 • **FR** Couvercle pour BRF-114 • **ES** Tapa para BRF-114
cm. 32x 70x 5h



143,00
2.5 / 0,01

PLF/9
09590401

PIASTRA LISCIA PER GRIGLIA IN GHISA
EN Smooth griddle plate for cast iron grid • **DE** Fortkochplatte glatt für Gusseisen Rost • **FR** Plaque lisse pour la grille en fonte • **ES** Plancha lisa para rejilla de hierro fundido
cm. 36x 39



200,00
11 / 0,01

PRF/9
09590403

PIASTRA RIGATA PER GRIGLIA IN GHISA
EN Grooved griddle plate for cast iron grid • **DE** Fortkochplatte gerillt für Gusseisen Rost • **FR** Plaque nervurée pour la grille en fonte • **ES** Plancha estriada para rejilla de hierro fundido
cm. 36x 39



269,00
11 / 0,01

PLFT/9
09590451

PIASTRA LISCIA PER GRIGLIA IN TONDINO
EN Smooth griddle plate for grid rod • **DE** Fortkochplatte glatt für Gitterstab • **FR** Plaque lisse pour tige grille • **ES** Plancha lisa por red de varilla
cm. 36x 39



194,00
11 / 0,01

PRFT/9
09590453

PIASTRA RIGATA PER GRIGLIA IN TONDINO
EN Grooved griddle plate for grid rod • **DE** Fortkochplatte gerillt für Gitterstab • **FR** Plaque nervurée pour tige grille • **ES** Plancha estriada por red de varilla
cm. 36x 39



259,00
11 / 0,01

ACCESSORI

MOD. _____
COD. _____

DESCRIZIONE/DESCRIPTION/BEZEICHNUNG/DESCRIPTION/DESCRIPCIÓN
DIMENSIONI/DIMENSIONS/ABMESSUNGEN/DIMENSIONS/DIMENSIONES

POTENZA/POWER/LEISTUNG/PUISSANCE/POTENCIA
VOLTAGGIO/VOLTAGE/SPANNUNG/VOLTAGE/VOLTAJE

⚡ kW kcal/h
⚡ kw V~ Hz

PREZZO/PRICE
PREIS/PRIX/PRECIO
KG / M³



533009200 GRIGLIA DI RIDUZIONE

EN Reduction • **DE** Reduzierstern • **FR** Grille de réduction • **ES** Rejilla de reducción
cm. 25x 25

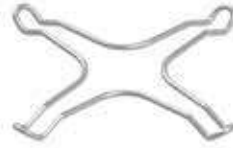

40,00
0.2 / 0,00

KIT-WOK 09580040

KIT WOK - FIAMMA VERTICALE - SOLO SU BRUCIATORE DA 10 KW E GRIGLIE IN GHISA

EN KIT WOK - vertical flame - only for 10 kW burner and cast iron grills
• **DE** KIT WOK - vertikaler Flamme - nur 10 kW-Brenner und Roste aus Gusseisen • **FR** KIT WOK - verticale de la flamme - seulement 10 kW brûleur et grilles en fonte • **ES** KIT WOK - llama vertical - sólo 10 kW quemador y parrillas de hierro colado
cm. Ø 26x 16h



422,00
5 / 0,02

RV

08660410

RISCALDANTE VANO

EN Heater for cabinet • **DE** Heizer für Schrankelement • **FR** Réchauffeur pour armoire • **ES** elemento de calefacción para armario neutro
cm. 32x 48,5x 8h

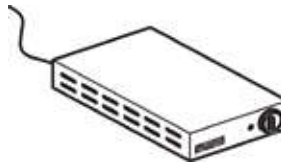

⚡ 0,75 kW
230V~
50/60 Hz

903,00
8 / 0,08

RRV-114

034F0401

RIPIANO (NO PER BM-114E)

EN Shelf (no for BM-114E) • **DE** Zwischenboden (nein für BM-114E) • **FR** Étagère (no pour BM-114E) • **ES** Estante (no para BM-114E)
cm. 34x 95x 10h



482,00
7 / 0,05

RRV-118

034F0801

RIPIANO (NO PER PC-118G)

EN Shelf (no for PC-118G) • **DE** Zwischenboden (nein für PC-118G) • **FR** Étagère (no pour PC-118G) • **ES** Estante (no para PC-118G)
cm. 74x 95x 10h



921,00
13 / 0,10

RRV-1110

034F1001

RIPIANO

EN Shelf • **DE** Abstellbrett • **FR** Étagère • **ES** Estante
cm. 94x 95x 10h

1.305,00
16 / 0,12

RRV-558

03450801

cm. 74x 46x 10h



601,00
7 / 0,05

TPA-11

035G0001

TESTATA CHIUSURA PIANO 2 LATI NON PER FUOCHI GAS (IN DOTAZIONE 1 PEZZO PER APPARECCHIO)

EN Head end filler strip 2 sides, no for gas burner (1 piece included in each machine) • **DE** Abschluss-Element 2 seiten, nein für Gasbrenner (1 Stück in jeder Maschine enthalten) • **FR** Élément de jonction 2 cotés, non pour brûleur à gaz (1 pièce incluse dans chaque machine) • **ES** Chapa de cierre 2 lados, no para quemador gas (1 pieza incluida en cada equipo)
cm. 0,2x 110x 5h



95,00
2 / 0,00

TPC-11

035G0002

TESTATA CHIUSURA PIANO 2 LATI PER FUOCHI GAS (IN DOTAZIONE 1 PEZZO PER APPARECCHIO)

EN Head end filler strip 2 sides, for gas burner (1 piece included in each machine) • **DE** Abschluss-Element 2 seiten, für Gasbrenner (1 Stück in jeder Maschine enthalten) • **FR** Élément de jonction 2 cotés, pour brûleur à gaz (1 pièce incluse dans chaque machine) • **ES** Chapa de cierre 2 lados, para quemador gas (1 pieza incluida en cada equipo)
cm. 0,2x 110x 5h



95,00
2 / 0,00

MOD. _____
COD. _____

DESCRIZIONE/DESCRIPTION/BEZEICHNUNG/DESCRIPTION/DESCRIPCIÓN
DIMENSIONI/DIMENSIONS/ABMESSUNGEN/DIMENSIONS/DIMENSIONES

POTENZA/POWER/LEISTUNG/PUISSANCE/POTENCIA
VOLTAGGIO/VOLTAGE/SPANNUNG/VOLTAGE/VOLTAJE

⚡ kW kcal/h
⚡ kw V~ Hz

PREZZO/PRICE
PREIS/PRIX/PRECIO
KG / M³



TPAC-11
035G0003

TESTATA CHIUSURA PIANO 2 LATI PER FUOCHI GAS DA 1 LATO

EN Head end filler strip 2 sides, with gas burner in 1 side • **DE** Abschluss-Element 2 seiten, mit Gasbrenner in 1 Seite • **FR** Élément de jonction 2 cotés, avec brûleur à gaz sur 1 côté • **ES** Chapa de cierre 2 lados, con quemador gas en 1 lado
cm. 0,2x 110x 5h



95,00
2 / 0,00

TPA-55
03560001

TESTATA CHIUSURA PIANO 1 LATO NON PER FUOCHI GAS (IN DOTAZIONE 1 PEZZO PER APPARECCHIO)

EN Head end filler strip 1 side, no for gas burner (1 piece included in each machine) • **DE** Abschluss-Element 1 seite, Nein für Gasbrenner (1 Stück in jeder Maschine enthalten) • **FR** Élément de jonction 1 cote, non pour brûleur à gaz (1 pièce incluse dans chaque machine) • **ES** Chapa de cierre 1 lado, no para quemador gas (1 pieza incluida en cada equipo)
cm. 0,2x 55x 5h



69,00
1 / 0,00

TMA-11
035E1100

TESTATA 2 LATI SERIE S110

EN Head 2 sides S110 • **DE** Abschluss element seiten S110 • **FR** Element de jonction 2 cotés S110 • **ES** Embellecedor 2 lados S110
cm. 0,2x 110x 74h



481,00
13 / 0,04

TMTA-11
035E1120

TESTATA TAMBURATA 2 LATI SERIE S110, CON STESSO PROFILO LINEA FRONTALE

EN Head 2 sides S110, with the same front line profile • **DE** Abschluss element seiten S110, mit dem gleichen Frontlinienprofil • **FR** Element de jonction 2 cotés S110, avec le même profil de ligne • **ES** Embellecedor 2 lados S110, con el mismo perfil de línea frontal
cm. 7,5x 110x 74h



1.415,00
24 / 0,24

ZB
01410000

ZOCCOLATURA BASE

EN FRONT PLINTH • **DE** GRUNDSOCKEL • **FR** PLINTHE FRONTAL • **ES** ZOCCOLOS BASE
€/m x cm. 15h



143,00
/

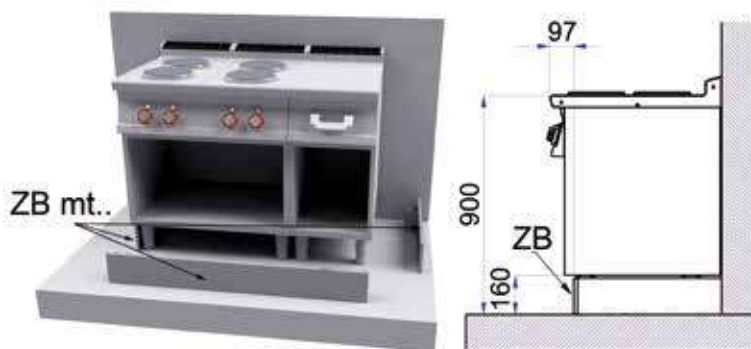



A series of horizontal dotted lines for writing, spanning the width of the page.



REFRIGERATED BASES



BASI REFRIGERATE

MOD. _____
COD. _____

DESCRIZIONE/DESCRIPTION/BEZEICHNUNG/DESCRIPTION/DESCRIPCIÓN
DIMENSIONI/DIMENSIONS/ABMESSUNGEN/DIMENSIONS/DIMENSIONES

POTENZA/POWER/LEISTUNG/PUISSANCE/POTENCIA
VOLTAGGIO/VOLTAGE/SPANNUNG/VOLTAGE/VOLTAJE

⚡ kcal/h ⚡ kW
230V~ V~
50 Hz Hz

PREZZO/PRICE
PREIS/PRIX/PRECIO
KG / M³



BRS-120
07423002

BASE REFRIGERATA CON 2 PORTE GRUPPO INCORPORATO
- TEMPERATURA: -2 °C +8 °C - 2 GRIGLIE GN 1/1 - 170 LT.
GAS REFRIGERANTE R290

EN Refrigerated stand with 2 doors Incorporated condensing unit
- Temperature: -2 °C +8 °C - 2 grids GN-1/1 - 170 lt. Refrigerant
gas R290 • **DE** Gekühlter Unterbau mit 2 Türen Aggregat eingebaut
- Temperaturbereich -2 °C +8 °C - 2 Gitter GN-1/1 - 170 lt. Kühlmittel
R290 • **FR** Soubassement réfrigéré avec 2 portes Compresseur incorporé
- Température -2 °C +8 °C - 2 grilles GN-1/1 - 170 lt. Réfrigérant
R290 • **ES** Mueble refrigerado con 2 puertas - Grupo incorporado
Temperatura de -2 °C +8 °C - 2 Rejilla GN-1/1 - 170 lt. Gas refrigerante
R290

cm. 120x 63x 59h



⚡ 0,25 kW **4.222,00**
230V~ 80 / 0,73
50 Hz

BRS-121
07423021

BASE REFRIGERATA CON PORTA E 2 CASSETTI GRUPPO
INCORPORATO - TEMPERATURA: -2 °C +8 °C - 1 GRIGLIA GN
1/1 - 170 LT. GAS REFRIGERANTE R290

EN Refrigerated stand with door and 2 drawers Incorporated
condensing unit - Temperature: -2 °C +8 °C - 1 grid GN-1/1 - 170 lt.
Refrigerant gas R290 • **DE** Gekühlter Unterbau mit Tür und 2 Schubladen
Aggregat eingebaut - Temperaturbereich -2 °C +8 °C - 1 Gitter GN-
1/1 - 170 lt. Kühlmittel R290 • **FR** Soubassement réfrigéré avec porte
et 2 tiroirs Compresseur incorporé - Température -2 °C +8 °C - 1 grille
GN-1/1 - 170 lt. Réfrigérant R290 • **ES** Mueble refrigerado con puerta
y 2 cajones Grupo incorporado - Temperatura de -2 °C +8 °C - 1 Rejilla
GN-1/1 - 170 lt. Gas refrigerante R290

cm. 120x 63x 59h



⚡ 0,25 kW **4.729,00**
230V~ 90 / 0,73
50 Hz

BRS-122
07423040

BASE REFRIGERATA CON 4 CASSETTI GRUPPO INCORPORATO
- TEMPERATURA: -2 °C +8 °C - 170 LT. GAS REFRIGERANTE
R290

EN Refrigerated stand with 4 drawers Incorporated condensing
unit - Temperature: -2 °C +8 °C - 170 lt. Refrigerant gas R290
• **DE** Gekühlter Unterbau mit 4 Schubladen Aggregat eingebaut
- Temperaturbereich -2 °C +8 °C - 170 lt. Kühlmittel R290 • **FR**
Soubassement réfrigéré avec 4 tiroirs Compresseur incorporé -
Température -2 °C +8 °C - 170 lt. Réfrigérant R290 • **ES** Mueble
refrigerado con 4 cajones Grupo incorporado - Temperatura de -2 °C
+8 °C - 170 lt. Gas refrigerante R290

cm. 120x 63x 59h



⚡ 0,25 kW **5.240,00**
230V~ 100 / 0,73
50 Hz

BRS-160
07423103

BASE REFRIGERATA CON 3 PORTE GRUPPO INCORPORATO
- TEMPERATURA: -2 °C +8 °C - 3 GRIGLIE GN 1/1 - 265 LT.
GAS REFRIGERANTE R290

EN Refrigerated stand with 3 doors Incorporated condensing unit
- Temperature: -2 °C +8 °C - 3 grids GN-1/1 - 265 lt. Refrigerant
gas R290 • **DE** Gekühlter Unterbau mit 3 Türen Aggregat eingebaut
- Temperaturbereich -2 °C +8 °C - 3 Gitter GN-1/1 - 265 lt. Kühlmittel
R290 • **FR** Soubassement réfrigéré avec 3 portes Compresseur incorporé
- Température -2 °C +8 °C - 3 grilles GN-1/1 - 265 lt. Réfrigérant
R290 • **ES** Mueble refrigerado con 3 puertas - Grupo incorporado
Temperatura de -2 °C +8 °C - 3 Rejilla GN-1/1 - 265 lt. Gas refrigerante
R290

cm. 160x 63x 59h



⚡ 0,28 kW **4.959,00**
230V~ 115 / 0,96
50 Hz

BRS-161
07423122

BASE REFRIGERATA CON 2 PORTE E 2 CASSETTI GRUPPO
INCORPORATO - TEMPERATURA: -2 °C +8 °C - 2 GRIGLIE GN
1/1 - 265 LT. GAS REFRIGERANTE R290

EN Refrigerated stand with 2 doors and 2 drawers Incorporated
condensing unit - Temperature: -2 °C +8 °C - 2 grids GN-1/1 - 265
lt. Refrigerant gas R290 • **DE** Gekühlter Unterbau mit 2 Türen und 2
Schubladen Aggregat eingebaut - Temperaturbereich -2 °C +8 °C - 2
Gitter GN-1/1 - 265 lt. Kühlmittel R290 • **FR** Soubassement réfrigéré
avec 2 portes et 2 tiroirs Compresseur incorporé - Température -2
°C +8 °C - 2 grilles GN-1/1 - 265 lt. Réfrigérant R290 • **ES** Mueble
refrigerado con 2 puertas y 2 cajones Grupo incorporado - Temperatura
de -2 °C +8 °C - 2 Rejilla GN-1/1 - 265 lt. Gas refrigerante R290

cm. 160x 63x 59h



⚡ 0,28 kW **5.469,00**
230V~ 125 / 0,96
50 Hz

BASI REFRIGERATE

MOD. _____
COD. _____

DESCRIZIONE/DESCRIPTION/BEZEICHNUNG/DESCRIPTION/DESCRIPCIÓN
DIMENSIONI/DIMENSIONS/ABMESSUNGEN/DIMENSIONS/DIMENSIONES

POTENZA/POWER/LEISTUNG/PUISSANCE/POTENCIA
VOLTAGGIO/VOLTAGE/SPANNUNG/VOLTAGE/VOLTAJE

⚡ kW _____
kcal/h _____
V~ _____
Hz _____

PREZZO/PRICE
PREIS/PRIX/PRECIO
KG / M³



BRS-162
07423141

BASE REFRIGERATA CON PORTA E 4 CASSETTI GRUPPO INCORPORATO - TEMPERATURA: -2 °C +8 °C - 265 LT. GAS REFRIGERANTE R290

EN Refrigerated stand with door and 4 drawers Incorporated condensing unit - Temperature: -2 °C +8 °C - 265 lt. Refrigerant gas R290 • **DE** Gekühlter Unterbau mit Tür und 4 Schubladen Aggregat eingebaut - Temperaturbereich -2 °C +8 °C - 265 lt. Kühlmittel R290 • **FR** Soubassement réfrigéré avec porte et 4 tiroirs Compresseur incorporé - Température -2 °C +8 °C - 265 lt. Réfrigérant R290 • **ES** Mueble refrigerado con puerta y 4 cajones Grupo incorporado - Temperatura de -2 °C +8 °C - 265 lt. Gas refrigerante R290
cm. 160x 63x 59h



⚡ 0,28 kW _____ **5.978,00**
230V~ _____ 130 / 0,96
50 Hz _____

BRS-210
07423304

BASE REFRIGERATA CON 4 PORTE GRUPPO INCORPORATO - TEMPERATURA: -2 °C +8 °C - 4 GRIGLIE GN 1/1 - 340 LT. GAS REFRIGERANTE R290

EN Refrigerated stand with 4 doors Incorporated condensing unit - Temperature: -2 °C +8 °C - 4 grids GN-1/1 - 340 lt. Refrigerant gas R290 • **DE** Gekühlter Unterbau mit 4 Türen Aggregat eingebaut - Temperaturbereich -2 °C +8 °C - 4 Gitter GN-1/1 - 340 lt. Kühlmittel R290 • **FR** Soubassement réfrigéré avec 4 portes Compresseur incorporé - Température -2 °C +8 °C - 4 grilles GN-1/1 - 340 lt. Réfrigérant R290 • **ES** Mueble refrigerado con 4 puertas - Grupo incorporado - Temperatura de -2 °C +8 °C - 4 Rejilla GN-1/1 - 340 lt. Gas refrigerante R290
cm. 210x 63x 59h



⚡ 0,37 kW _____ **5.553,00**
230V~ _____ 150 / 1,31
50 Hz _____

BRS-211
07423342

BASE REFRIGERATA CON 2 PORTE E 4 CASSETTI GRUPPO INCORPORATO - TEMPERATURA: -2 °C +8 °C - 2 GRIGLIE GN 1/1 - 340 LT. GAS REFRIGERANTE R290

EN Refrigerated stand with 2 doors and 4 drawers Incorporated condensing unit - Temperature: -2 °C +8 °C - 2 grids GN-1/1 - 340 lt. Refrigerant gas R290 • **DE** Gekühlter Unterbau mit 2 Türen und 4 Schubladen Aggregat eingebaut - Temperaturbereich -2 °C +8 °C - 2 Gitter GN-1/1 - 340 lt. Kühlmittel R290 • **FR** Soubassement réfrigéré avec 2 portes et 4 tiroirs Compresseur incorporé - Température -2 °C +8 °C - 2 grilles GN-1/1 - 340 lt. Réfrigérant R290 • **ES** Mueble refrigerado con 2 puertas y 4 cajones Grupo incorporado - Temperatura de -2 °C +8 °C - 2 Rejilla GN-1/1 - 340 lt. Gas refrigerante R290
cm. 210x 63x 59h



⚡ 0,37 kW _____ **6.573,00**
230V~ _____ 168 / 1,31
50 Hz _____

BRS-1CASS

SOVRAPPREZZO PER 1 CASSETTONE (SOLO TN)

EN overprice for of 1 big drawers (only TN) • **DE** Preiserhorung für Schubladen (nur TN) • **FR** Augmentation de prix pour 1 tiroir (seulement TN) • **ES** Incremento de precio por 1 cajone (solo TN)



497,00
/

BRS-2CASS

SOVRAPPREZZO PER 2 CASSETTI 1/2 (SOLO TN)

EN overprice for of 2 x 1/2 drawers (only TN) • **DE** Preiserhorung für schubladen 2 x 1/2 (nur TN) • **FR** Augmentation de prix pour tiroirs 2 x 1/2 (seulement TN) • **ES** Incremento de precio por cajones 2 x 1/2 (solo TN)



507,00
/

BASI REFRIGERATE

MOD. _____
COD. _____

DESCRIZIONE/DESCRIPTION/BEZEICHNUNG/DESCRIPTION/DESCRIPCIÓN
DIMENSIONI/DIMENSIONS/ABMESSUNGEN/DIMENSIONS/DIMENSIONES

POTENZA/POWER/LEISTUNG/PUISSANCE/POTENCIA
VOLTAGGIO/VOLTAGE/SPANNUNG/VOLTAGE/VOLTAJE

⚡ $\frac{0,46 \text{ kW}}{230\text{V}\sim}$ $\frac{0,46 \text{ kW}}{50 \text{ Hz}}$

PREZZO/PRICE
PREIS/PRIX/PRECIO
KG / M³



BSBT-120
07424002

**BASE REFRIGERATA CON 2 PORTE GRUPPO INCORPORATO -
TEMPERATURA: -15/-18 °C - 2 GRIGLIE GN 1/1 - 170 LT. GAS
REFRIGERANTE R290**

EN Refrigerated stand with 2 doors Incorporated condensing unit
- Temperature: -15/-18 °C - 2 grids GN-1/1 - 170 lt. Refrigerant gas
R290 • **DE** Gekühlter Unterbau mit 2 Türen Aggregat eingebaut -
Temperaturbereich -15/-18 °C - 2 Gitter GN-1/1 - 170 lt. Kühlmittel
R290 • **FR** Soubassement réfrigéré avec 2 portes Compresseur incorporé
- Température -15/-18 °C - 2 grilles GN-1/1 - 170 lt. Réfrigérant
R290 • **ES** Mueble refrigerado con 2 puertas - Grupo incorporado
Temperatura de -15/-18 °C - 2 Rejilla GN-1/1 - 170 lt. Gas refrigerante
R290

cm. 120x 63x 59h



⚡ $\frac{0,46 \text{ kW}}{230\text{V}\sim}$ $\frac{0,46 \text{ kW}}{50 \text{ Hz}}$ **4.869,00**
82 / 0,73

BSBT-125
07424020

**BASE REFRIGERATA CON 2 CASSETTONI GRUPPO
INCORPORATO - TEMPERATURA: -15/-18 °C - 170 LT. GAS
REFRIGERANTE R290**

EN Refrigerated stand with 2 big drawers Incorporated condensing unit
- Temperature: -15/-18 °C - 170 lt. Refrigerant gas R290 • **DE** Gekühlter
Unterbau mit 2 Schubladen Aggregat eingebaut - Temperaturbereich
-15/-18 °C - 170 lt. Kühlmittel R290 • **FR** Soubassement réfrigéré
avec 2 tiroirs Compresseur incorporé - Température -15/-18 °C - 170
lt. Réfrigérant R290 • **ES** Mueble refrigerado con 2 cajones Grupo
incorporado - Temperatura de -15/-18 °C - 170 lt. Gas refrigerante R290

cm. 120x 63x 59h



⚡ $\frac{0,46 \text{ kW}}{230\text{V}\sim}$ $\frac{0,46 \text{ kW}}{50 \text{ Hz}}$ **5.409,00**
95 / 0,73

BSBT-160
07424103

**BASE REFRIGERATA CON 3 PORTE GRUPPO INCORPORATO -
TEMPERATURA: -15/-18 °C - 3 GRIGLIE GN 1/1 - 265 LT. GAS
REFRIGERANTE R290**

EN Refrigerated stand with 3 doors Incorporated condensing unit
- Temperature: -15/-18 °C - 3 grids GN-1/1 - 265 lt. Refrigerant gas
R290 • **DE** Gekühlter Unterbau mit 3 Türen Aggregat eingebaut -
Temperaturbereich -15/-18 °C - 3 Gitter GN-1/1 - 265 lt. Kühlmittel
R290 • **FR** Soubassement réfrigéré avec 3 portes Compresseur incorporé
- Température -15/-18 °C - 3 grilles GN-1/1 - 265 lt. Réfrigérant
R290 • **ES** Mueble refrigerado con 3 puertas - Grupo incorporado
Temperatura de -15/-18 °C - 3 Rejilla GN-1/1 - 265 lt. Gas refrigerante
R290

cm. 160x 63x 59h



⚡ $\frac{0,75 \text{ kW}}{230\text{V}\sim}$ $\frac{0,75 \text{ kW}}{50 \text{ Hz}}$ **5.608,00**
118 / 0,96

BSBT-165
07424130

**BASE REFRIGERATA CON 3 CASSETTONI GRUPPO
INCORPORATO - TEMPERATURA: -15/-18 °C - 265 LT. GAS
REFRIGERANTE R290**

EN Refrigerated stand with 3 big drawers Incorporated condensing unit
- Temperature: -15/-18 °C - 265 lt. Refrigerant gas R290 • **DE** Gekühlter
Unterbau mit 3 Schubladen Aggregat eingebaut - Temperaturbereich
-15/-18 °C - 265 lt. Kühlmittel R290 • **FR** Soubassement réfrigéré
avec 3 tiroirs Compresseur incorporé - Température -15/-18 °C - 265
lt. Réfrigérant R290 • **ES** Mueble refrigerado con 3 cajones Grupo
incorporado - Temperatura de -15/-18 °C - 265 lt. Gas refrigerante R290

cm. 160x 63x 59h



⚡ $\frac{0,75 \text{ kW}}{230\text{V}\sim}$ $\frac{0,75 \text{ kW}}{50 \text{ Hz}}$ **6.420,00**
132 / 0,96

40105000 GRIGLIA GN 1/1

EN grid GN 1/1 • **DE** gitter GN 1/1 • **FR** Grille GN 1/1 • **ES**
Rejilla GN 1/1



51,00
/ 0,00

40105010 COPPIA GUIDE

EN pair of guides • **DE** Führer • **FR** Couple de guides • **ES** Pareja
guía

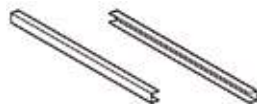

47,00
/ 0,00

ACCESSORI BASI REFRIGERATE

MOD. _____
COD. _____

DESCRIZIONE/DESCRIPTION/BEZEICHNUNG/DESCRIPTION/DESCRIPCIÓN
DIMENSIONI/DIMENSIONS/ABMESSUNGEN/DIMENSIONS/DIMENSIONES

POTENZA/POWER/LEISTUNG/PUISSANCE/POTENCIA
VOLTAGGIO/VOLTAGE/SPANNUNG/VOLTAGE/VOLTAJE

↓ kW kcal/h
↗ kW V~ Hz

PREZZO/PRICE
PREIS/PRIX/PRECIO
KG / M³



_40200560 VOLTAGGIO E FREQUENZA 220V~ /60HZ, PER BASI REFRIGERATE
EN Voltage and frequency 220V~ /60Hz, for Refrigerated stand • **DE** Spannung und Frequenz 220V~ /60Hz für Gekühlter Unterbau • **FR** Tension et fréquence 220V~ /60Hz pour Soubassement réfrigéré • **ES** Voltaje y frecuencia 220V~ /60Hz para Mueble refrigerado



+4%
/

K60-BRS120 KIT FISSAGGIO S60 SU BASE REFRIGERATA
 07423006 **EN** Fixing kit for S60 on refrigerated stand • **DE** Befestigungs-Kit für S60 auf Gekühlter Unterbau • **FR** kit de fixation pour S60 sur le soubassement réfrigéré • **ES** kit de fijación para S60 en Mueble refrigerado
cm. 120



108,00
/ 0,00

K60-BRS160 cm. 160
07423106

124,00
/ 0,01

K60-BRS210 cm. 210
07423306

151,00
/ 0,01

K65-BRS120 KIT FISSAGGIO S65 SU BASE REFRIGERATA
 07423007 **EN** Fixing kit for S65 on refrigerated stand • **DE** Befestigungs-Kit für S65 auf Gekühlter Unterbau • **FR** kit de fixation pour S65 sur le soubassement réfrigéré • **ES** kit de fijación para S65 en Mueble refrigerado
cm. 120



112,00
/ 0,00

K65-BRS160 cm. 160
07423107

126,00
/ 0,01

K65-BRS210 cm. 210
07423307

155,00
/ 0,01

K70-BRS120 KIT FISSAGGIO S70 SU BASE REFRIGERATA
 07423008 **EN** Fixing kit for S70 on refrigerated stand • **DE** Befestigungs-Kit für S70 auf Gekühlter Unterbau • **FR** kit de fixation pour S70 sur le soubassement réfrigéré • **ES** kit de fijación para S70 en Mueble refrigerado
cm. 120



119,00
/ 0,00

K70-BRS160 cm. 160
07423108

131,00
/ 0,01

K70-BRS210 cm. 210
07423308

157,00
/ 0,01

K90-BRS120 KIT SUPPORTO E FISSAGGIO S90 SU BASE REFRIGERATA
 07423009 **EN** support and fixing kit for S90 on refrigerated stand • **DE** Unterstützung und Befestigungs-Kit für S90 auf Gekühlter Unterbau • **FR** kit de fixation et support pour S90 sur le soubassement réfrigéré • **ES** kit de soporte y fijación para S90 en Mueble refrigerado
cm. 120x 20

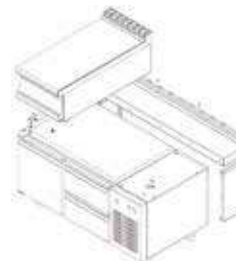

244,00
/ 0,01

K90-BRS160 cm. 160x 20
07423109

262,00
/ 0,02

K90-BRS210 cm. 210x 20
07423309

287,00
/ 0,02



A series of horizontal dotted lines for writing, spanning the width of the page.





FREEBLOCK



FREEBLOCK 5.0



LED optional



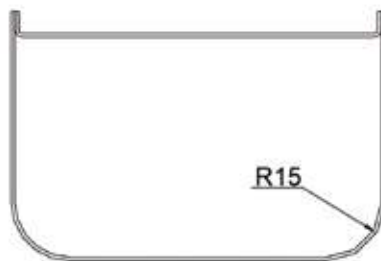
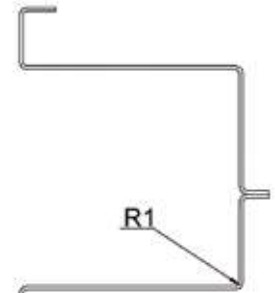
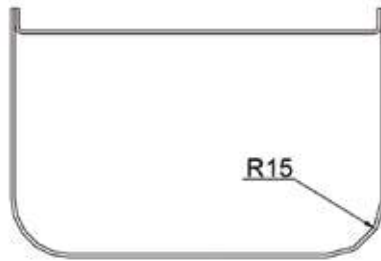
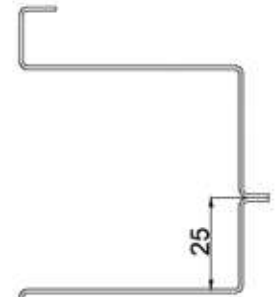
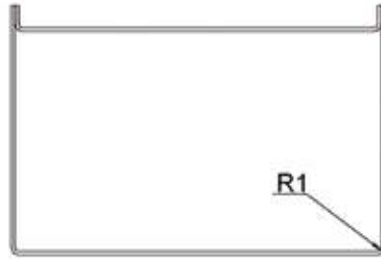

MOD. _____
COD. _____

DESCRIZIONE/DESCRIPTION/BEZEICHNUNG/DESCRIPTION/DESCRIPCIÓN
DIMENSIONI/DIMENSIONS/ABMESSUNGEN/DIMENSIONS/DIMENSIONES

POTENZA/POWER/LEISTUNG/PUISSANCE/POTENCIA
VOLTAGGIO/VOLTAGE/SPANNUNG/VOLTAGE/VOLTAJE

$\frac{kW}{kcal/h}$ $\frac{V}{Hz}$

PREZZO/PRICE
PREIS/PRIX/PRECIO
KG / M³



FREEBLOCK IL MONOBLOCCO FREEBLOCK È COMPOSTO DA STRUTURA INTERNA, VANI IGIENICI E NON, PANNELLO COMANDI, PIANO ECC... TUTTO È INTERAMENTE REALIZZATO IN ACCIAIO INOX 18/10 FINEMENTE SATINATO, CON PARTICOLARI CROMATI, IL PIANO VIENE INFINE SPAZZOLATO FINO AD OTTENERE UN EFFETTO FINALE ANTIGRAFFIO.

EN The monoblock FREEBLOCK is made up internal frame, hygienic and not hygienic compartments, control panel, top etc. ... everything is made entirely of stainless steel 18/10 with fine satin finish, with chromed details, the top is brushed to obtain a scratchproof effect. • **DE** Das Monoblock FREEBLOCK besteht aus einer internen Struktur, Hygiene oder normale Unterschränke, Bedienungsblende, Oberfläche kratzfest...komplett aus CNS 18/10 mit feinem Schliff, ergänzt mit verchromten Teilen. • **FR** Le monobloc FREEBLOCK se compose de structure interne, avec vannes hygiéniques ou pas, panneau de commandes, plan, etc... tout est fait entièrement en acier inoxydable 18/10 satiné avec des touches de chrome. Le plan est ensuite brossé pour obtenir un effet anti-rayures. • **ES** El monobloc FREEBLOCK se compone por una estructura interna, armarios normales ó higiénicos, panel de control, sobre de trabajo, etc... todo realizado completamente en acero inoxidable 18/10 con acabado satinado fino con detalles cromados, el plano de trabajo suficientemente satinado hasta obtener un efecto a prueba de arañazos.





FREEBLOCK 5_0 FREEBLOCK 5.0. IL PIANO È UN PEZZO UNICO CON FIANCHI CHE ARRIVANO A TERRA E SONO PORTANTI, TUTTO IN ACCIAIO INOX AISI 304 CRNI 18/10 CON SATINATURA ANTIGRAFFIO E SPESSORE DA 3 MM, RINFORZATO CON TRAVERSE AVVITATE. STRUTTURA E TELAIO INTERAMENTE PORTANTI. GLI ELEMENTI DROP-IN POSSONO ESSERE INSTALLATI INCASSATI E SILICONATI O ESSERE SALDATI INTERAMENTE AL PIANO. INSTALLAZIONE DEI MODELLI A INDUZIONE CON VETRO SILICONATO A LIVELLO DEL PIANO SENZA TELAIO D'INGOMBRO. PREVISTO VANO CON GRIGLIA E FILTRO SMONTABILE PER L'AERAZIONE DEL GENERATORE INDUZIONE. PORTE TAMBURATE E SALDATE, RINFORZATE ALL'INTERNO CON POLISTIROLO AD ALTA DENSITÀ. È PRESENTE UN VANO TECNICO SPECIFICO, DI FACILE ISPEZIONE, PER LA SCATOLA ELETTRICA CHE CONTIENE TUTTI I COLLEGAMENTI. CASSETTI E PORTE DOTATE DI RALLENTATORE IN CHIUSURA. POSSIBILITÀ DI VANI ILLUMINATI DA STRIP LED CHE SI ATTIVA ALL'APERTURA DELLA PORTA RELATIVA TRAMITE "MICROSWITCH".



EN FREEBLOCK 5.0. The top is a single piece, the sides go down to the ground and are load-bearing. It's entirely in stainless steel AISI 304 CrNi 18/10, 3 mm thick with scratch-proof satin finish, reinforced with bolted crossbars. Structure and frame are entirely load-bearing. The drop-in elements can be installed as recessed and silicone fastened or they can be welded entirely to the top. Installation of the induction models with silicon-coated glass at the level of the top without a cumbersome frame. Includes compartment with grill and removable filter for the aeration of the induction generator. All the doors are hollow core and entirely welded, reinforced internally with high-density polystyrene. A specific technical compartment is present, allowing easy inspection of the electrical box that contains all the connections. Drawers and doors equipped with soft closure. Possibility of compartments illuminated by strip LEDs that turn on at the opening of the relative door by "microswitch".

• DE FREEBLOCK 5.0. Die Platte ist aus einem einzigen Stück mit bis zum Boden tragenden Seiten, alle aus Edelstahl AISI 304 CrNi 18/10 mit kratzfester, satiniertes Oberfläche und einer Dicke von 3 mm, verstärkt mit verschraubten Querstreben. Struktur und Rahmen vollständig tragend. Die Drop-in-Elemente können versenkt und silikonisiert oder vollständig mit dem Boden verschweißt werden. Installation der Induktionsmodelle mit silikonisiertem Glas auf der Höhe der Oberseite ohne Rahmen. Ausgestattetes Fach mit Gitter und abnehmbarem Filter zur Belüftung des Induktionsgenerators. Türen wabenförmig gekernt und geschweißt, innen mit hochdichtem Polystyrol verstärkt. Es gibt einen speziellen, leicht zu inspizierenden Technikraum für den Elektrokasten, der alle Anschlüsse enthält. Schubladen und Türen, die mit einer Schließverzögerung ausgestattet sind. Möglichkeit von Fächern, die von Streifen-LEDs beleuchtet werden, die beim Öffnen der entsprechenden Tür mit Hilfe eines "microswitch" aktiviert werden.

• FR FREEBLOCK 5.0. Le plan est une pièce unique avec les côtés qui arrivent jusqu'à terre et portants, le tout en acier inox AISI 304 CrNi 18/10 satiné anti-rayures et épaisseur de 3 mm, renforcé par des traverses vissées. Structure et châssis entièrement portants. Les éléments drop-in peuvent être installés encastrés et siliconés ou être soudés entièrement au plan. Installation des modèles à induction avec verre siliconé au niveau du plan sans structure encombrante. Un compartiment avec grille est prévu, ainsi qu'un filtre démontable pour l'aération du générateur à induction. Portes alvéolaires et soudées, renforcées à l'intérieur par du polystyrène à haute densité. Il y a un compartiment technique spécifique, d'inspection facile, pour le boîtier électrique qui contient tous les raccordements. Tiroirs et portes équipés de fermeture amortie. Possibilité de compartiments éclairés par bande led qui s'active à l'ouverture de la porte relative à travers un "microswitch".

• ES FREEBLOCK 5.0. La parte superior es una sola pieza con laterales hasta el suelo que soportan la carga, todo en acero inoxidable AISI 304 CrNi 18/10 con acabado satinado resistente a los arañazos y 3 mm de espesor, reforzado con travesaños atornillados. Estructura y armazón que soportan completamente la carga. Los elementos drop-in pueden instalarse empotrados y siliconados o pueden soldarse completamente al suelo. Instalación de los modelos de inducción con vidrio siliconado a nivel de la parte superior sin marco. Compartimento provisto de rejilla y filtro extraíble para la ventilación del generador de inducción. Puertas huecas y soldadas, reforzadas por dentro con poliestireno de alta densidad. Hay un compartimento técnico específico, fácil de inspeccionar, para la caja eléctrica que contiene todas las conexiones. Cajones y puertas equipadas con retardador de cierre. Posibilidad de compartimentos iluminados por una tira de leds que se activa al abrir la puerta correspondiente mediante "microswitch".





FREEBLOCK 5_0 B VERSIONE FREEBLOCK 5.0 B, CON PIANO IN PEZZO UNICO FINO ALLA COPERTURA DEL PANNELLO COMANDI E FIANCHI TERMINALI CHE ARRIVANO A TERRA SEPARATI. PER FACILITARNE IL TRASPORTO E LA MOVIMENTAZIONE PUR MANTENENDO L'ESTETICA DEL FREEBLOCK 5.0

EN FREEBLOCK 5.0 B version, that is, with a single piece top up to the level of the control panel and separate sides that come to the ground. To facilitate transport and handling while maintaining the aesthetics of FREEBLOCK 5.0 • **DE** FREEBLOCK Version 5.0 B, mit fugenfreiem Oberteil bis zur Höhe des Bedienfelds hinuntergezogen und separaten Seitenteilen die bis zum Boden reichen. Dies erleichtert den Transport und die Handhabung unter Beibehaltung der Ästhetik von FREEBLOCK 5.0 • **FR** Version FREEBLOCK 5.0 B, c'est-à-dire avec un haut monobloc jusqu'au niveau du panneau de commande et des côtés latéraux séparés qui atteignent le sol. Pour faciliter le transport et la manutention tout en conservant l'esthétique de FREEBLOCK 5.0 • **ES** Versión FREEBLOCK 5.0 B, es decir, con una sola pieza que se completa hasta el nivel del panel de control y laterales separados que llegan al suelo. Para facilitar el transporte y la manipulación manteniendo la estética de FREEBLOCK 5.0



- /

FREEBLOCK 5_0 C VERSIONE FREEBLOCK 5.0 C, CON PIANO IN PEZZO UNICO SOLO SUPERIORE CON SBORDO LATERALE DI CM.7,5, PANNELLO COMANDI E FIANCATA TAMBURATA IN ESTETICA CON IL LATO FRONTALE.

EN FREEBLOCK 5.0 C version, that is, with a single piece top only with a lateral edge of 7.5 cm, a control panel and a side panel in aesthetics with the front side. • **DE** FREEBLOCK Version 5.0 C, mit fugenfreiem Oberteil und seitlichem Überstand von 7,5 cm. Bedienfeld und doppelwandige Seitenteile in selber Ästhetik wie die Gerätefront. • **FR** Version FREEBLOCK 5.0 C, c'est-à-dire avec un dessus monobloc uniquement avec un bord latéral de 7,5 cm, un panneau de commande et un panneau latéral en esthétique avec la face avant. • **ES** Versión FREEBLOCK 5.0 C, es decir, con una parte superior de una sola pieza con un borde lateral de 7,5 cm, un panel de control y lateral en estética con el lado frontal



- /

PTM-POTS STRUTTURA PORTATEGAMI PER MONOBLOCCO (REALIZZAZIONI A PROGETTO)

EN pot rack structure for monoblock (realizations for project) • **DE** Ablagerost für Kochwerkzeuge, für monoblock (Realisierungen im Projekt) • **FR** structures porte casseroles pour monobloc (réalisations en projet) • **ES** estructuras superiores porta cazuelas para monobloc (logros en el proyecto)
cm. ...x 70x 76,5h



- /

PTM-POTS-SL STRUTTURA PORTATEGAMI PER MONOBLOCCO CON ABBASSAMENTO PORTASALAMANDRA (REALIZZAZIONI A PROGETTO)

EN pot rack structure for monoblock with salamander support (realizations for project) • **DE** Ablagerost für Kochwerkzeuge, für monoblock mit Salamander Konsolen (Realisierungen im Projekt) • **FR** structures porte casseroles pour monobloc avec porte salamandres (réalisations en projet) • **ES** estructuras superiores porta cazuelas para monobloc con porta salamandra (logros en el proyecto)
cm. ...x 70x 76,5h



- /

PSM-SL SUPPORTO SALAMANDRA PER MONOBLOCCO

EN salamander support, for monoblock • **DE** Salamander Konsolen, für monoblock • **FR** porte salamandres pour monobloc • **ES** porta salamandra para monobloc
cm. 60x 50x 40h



910,00
10 / 0,20

MOD. _____
COD. _____

DESCRIZIONE/DESCRIPTION/BEZEICHNUNG/DESCRIPTION/DESCRIPCIÓN
DIMENSIONI/DIMENSIONS/ABMESSUNGEN/DIMENSIONS/DIMENSIONES

POTENZA/POWER/LEISTUNG/PUISSANCE/POTENCIA
VOLTAGGIO/VOLTAGE/SPANNUNG/VOLTAGE/VOLTAJE

⚡ kW _____
kcal/h _____
⚡ kw _____
V~ _____
Hz _____

PREZZO/PRICE
PREIS/PRIX/PRECIO
KG / M³



SCHUKO
537060400

PRESA ELETTRICA SCHUKO 230V~ / 16A IN PLASTICA GRIGIA IP44

EN Schuko electrical outlet, 230V~ / 16A gray plastic IP44 • **DE** Schuko Steckdose, 230V~ / 16A grauer Kunststoff IP44 • **FR** prise de courant Schuko, 230V~ / 16A plastique gris IP44 • **ES** toma de corriente eléctrica schuko, 230V~ / 16A de plástico gris IP44
cm. 9x 9x 3



211,00
0.3 / 0,00

SCHUKOS
537061600

PRESA ELETTRICA SCHUKO 230V~ / 16A IN METALLO CROMATO IP54

EN Schuko electrical outlet, 230V~ / 16A chromed metal IP54 • **DE** Schuko Steckdose, 230V~ / 16A métal chromé IP54 • **FR** prise de courant Schuko, 230V~ / 16A verchromtes Metall IP54 • **ES** toma de corriente eléctrica schuko, 230V~ / 16A de metal cromado IP54
cm. 8x 8x 4,5



445,00
0.3 / 0,00

CEAMS
19580012

COLONNA EROGAZIONE ACQUA CALDA E FREDDA CON CANNA SNODABILE, PER MONOBLOCCO

EN Pillar tap, hot and cold water • **DE** Mischbatterie, Warm- und Kaltwasser • **FR** Colonne de distribution eau froide et chaude • **ES** Rubinetto dispensador de agua caliente y fría
cm. 12x 12x 68h



712,00
6 / 0,03

TOWER
1958001A

COLONNA DI SERVIZIO: CORPO INOX CM.12X12X25H CON 2 PRESE ELETTRICHE MOD: SCHUKOS, PROFILO FERMA UTENSILI/MIXER CON BACINELLA GN1/6 INFERIORE, RUBINETTO ACQUA CALDA E FREDDA CON CANNA SNODABILE CON ANTIGOCCIA.

EN Service Tower: inox body cm.12x12x25h with 2 electrical outlet mod: SCHUKOS, bracket for tools/mixer block with GN1/6 container inferior, Pillar tap with hot and cold water with dripless. • **DE** : Servicemöbel: Körper aus rostfreiem Stahl cm.12x12x25h mit 2 Steckdosen Mod: SCHUKOS, Werkzeug-/Mischhalterprofil mit GN1/6 Bodenbecken, Warm- und Kaltwasserhahn mit Gelenkrohr mit Tropfschutz. • **FR** colonne de service : corps inox cm.12x12x25h avec 2 prises électriques mod : SCHUKOS, profil bloque ustensiles/mixer avec bac GN1/6 inférieur, robinet eau chaude et froide avec douchette et système anti-gouttes. • **ES** columna de servicio: cuerpo de acero inoxidable cm.12x12x25h con 2 tomas eléctricas mod: SCHUKOS, perfil portaherramientas/mezclador con bandeja inferior GN1/6, grifo de agua caliente y fría con tubo articulado con antigoteo.
cm. 21x 27x 67h



2.214,00
13 /

MP240VV
_1534760

MIXER AD IMMERSIONE MINI. VELOCITÀ VARIABILE DA 2000 A 12500 GIRI/MIN. COLTELLO, CAMPANA E FUSTO IN INOX LUNGO 240 MM.

EN MIXER mini. Speed variator 2000/12500 rpm, inox The foot, blade and tube 240mm. • **DE** Stabmixer mini. Geschwindigkeitsvariator 2000/12500 rpm, Messer und Stab 240mm aus Edelstahl. • **FR** Mixer Plongeant mini. variateur de vitesse 2000/12500 rpm, Couteau et tube en inox 240mm. • **ES** TRITURADORES mini. Velocidad variable de 2000 a 12.500 rpm. Cuchilla, campana y tubo de acero inoxidable de una longitud de 240 mm.
cm. 15x 15x 54h



⚡ 0,29 KW _____
230V~ _____
50 Hz _____

601,00
2.5 / 1,00

MOD. _____
COD. _____

DESCRIZIONE/DESCRIPTION/BEZEICHNUNG/DESCRIPTION/DESCRIPCIÓN
DIMENSIONI/DIMENSIONS/ABMESSUNGEN/DIMENSIONS/DIMENSIONES

POTENZA/POWER/LEISTUNG/PUISSANCE/POTENCIA
VOLTAGGIO/VOLTAGE/SPANNUNG/VOLTAGE/VOLTAJE

⚡ **kW** _____
kcal/h _____
⚡ **kW** _____
V~ _____
Hz _____

PREZZO/PRICE _____
PREIS/PRIX/PRECIO _____
KG / M³ _____



MPFRUSTA **FRUSTA PER MIXER MP240**
_6027333 **EN** Whip for MP240 • **DE** Peitsche für MP240 • **FR** fouet pour MP240
• **ES** Batidor para MP240



250,00
0.5 / 0,00

BMD-64EM **BAGNOMARIA MONOFASE VASCA PER GN 1/1 H.15**
26050410 **EN** Bain marie singlephase - Bowl for GN 1/1 h.15 • **DE** Wasserbäder einphasig - Becken GN 1/1 h.15 • **FR** Bain marie monophasé - Cuve GN 1/1 h.15 • **ES** Baño de maría monofásico - Cuba para GN 1/1 15h
cm. 40x 60x 30h



⚡ **2,1 kW** _____ **1.112,00**
230V~ _____ 18 / 0,13
50/60 Hz _____

BMD-68ET **BAGNOMARIA TRIFASE VASCA PER GN 2/1 H.15**
26050830 **EN** Bain marie threephase - Bowl for GN 2/1 h.15 • **DE** Wasserbäder Dreiphasig - Becken GN 2/1 h.15 • **FR** Bain marie triphase - Cuve GN 2/1 h.15 • **ES** Baño de maría trifásico - Cuba para GN 2/1 15h
cm. 80x 60x 30h



⚡ **4,2 kW** _____ **1.840,00**
400V~2N _____ 40 / 0,22
230V~3 _____
50/60 Hz _____

BMD-82EM **BAGNOMARIA MONOFASE VASCA PER 7XGN 1/9 H15**
28050210 **EN** Bain marie singlephase - Bowl for 7xGN 1/9 h.15 • **DE** Wasserbäder einphasig - Becken für 7xGN 1/9 h.15 • **FR** Bain marie monophasé - Cuve pour 7xGN 1/9 h.15 • **ES** Baño de maría monofásico - Cuba para 7xGN 1/9 h.15
cm. 20x 80x 30h



⚡ **1,65 kW** _____ **1.467,00**
230V~ _____ 16 / 0,17
50/60 Hz _____

BMD-84EM **BAGNOMARIA MONOFASE VASCA PER GN 1/1 + GN 1/3 H15**
28050410 **EN** Bain marie singlephase - Bowl for GN 1/1 + GN 1/3 h.15 • **DE** Wasserbäder einphasig - Becken GN 1/1 + GN 1/3 h.15 • **FR** Bain marie monophasé - Cuve GN 1/1 + GN 1/3 h.15 • **ES** Baño de maría monofásico - Cuba para GN 1/1 + GN 1/3 15h
cm. 40x 80x 30h



⚡ **2,85 kW** _____ **1.779,00**
230V~ _____ 21 / 0,23
50/60 Hz _____

BSD-64EM **CONTENITORE CALDO CON INFRAROSSO MONOFASE VASCA**
26040410 **CM. 30,5X51X16,5H CON FALSO FONDO FORATO**
EN Fry dump singlephase with infra-red heater. Bowl cm. 30,5x51x16,5h with perforated double bottom • **DE** Frittenwanne Einphasig mit Infrarotstrahler. Becke cm. 30,5x51x16,5h mit gelochtem Bodenrost • **FR** Silo a frites monophasé avec infrarouge. Cuve cm 30,5x51x16,5h avec doublefond perforé. • **ES** Contenedor caliente por infrarrojo monofásico. Cuba cm. 30,5x51x16,5h con falso fondo agujereado
cm. 40x 60x 25h



⚡ **1,47 kW** _____ **1.141,00**
230V~ _____ 20 / 0,13
50/60 Hz _____

BRASIERE FISSE MULTIFUNZIONE ELETTRICHE 60

MOD. _____
COD. _____

DESCRIZIONE/DESCRIPTION/BEZEICHNUNG/DESCRIPTION/DESCRIPCIÓN
DIMENSIONI/DIMENSIONS/ABMESSUNGEN/DIMENSIONS/DIMENSIONES

POTENZA/POWER/LEISTUNG/PUISSANCE/POTENCIA
VOLTAGGIO/VOLTAGE/SPANNUNG/VOLTAGE/VOLTAJE

⚡ kW kcal/h
⚡ kw V~ Hz

PREZZO/PRICE
PREIS/PRIX/PRECIO
KG / M³



BRFD-64ET **BRASIERA FISSA MULTIFUNZIONALE ELETTRICA VASCA CM. 30X51X10H**

26070433

EN Electric multi-function fixed braising pan - Bowl cm. 30x51x10h
 • **DE** Elektrische Multifunktionsbratpfanne Fest Becken cm. 30x51x10h
 • **FR** Sauteuse fixe multifonction électrique - Cuve cm. 30x51x10h • **ES** Sartén fija multifunción eléctrica - Cuba cm. 30x51x10h
cm. 40x 60x 28h



⚡ 4 kW **2.515,00**
 400V~2N 45 / 0,13
 230V~3
 50/60 Hz

BRFD-68ET **BRASIERA FISSA MULTIFUNZIONALE ELETTRICA VASCA CM. 70X51X10H**

26070833

EN Electric multi-function fixed braising pan - Bowl cm. 70x51x10h
 • **DE** Elektrische Multifunktionsbratpfanne Fest Becken cm. 70x51x10h
 • **FR** Sauteuse fixe multifonction électrique - Cuve cm. 70x51x10h • **ES** Sartén fija multifunción eléctrica - Cuba cm. 70x51x10h
cm. 80x 60x 28h



⚡ 8 kW **4.441,00**
 400V~3N 65 / 0,32
 50/60 Hz

BRFD-84ET **BRASIERA FISSA MULTIFUNZIONALE ELETTRICA VASCA CM. 30X68X10H**

28070433

EN Electric multi-function fixed braising pan - Bowl cm. 30x68x10h
 • **DE** Elektrische Multifunktionsbratpfanne Fest Becken cm. 30x68x10h
 • **FR** Sauteuse fixe multifonction électrique - Cuve cm. 30x68x10h • **ES** Sartén fija multifunción eléctrica - Cuba cm. 30x68x10h
cm. 40x 80x 28h



⚡ 5,2 kW **2.769,00**
 400V~2N 60 / 0,23
 50/60 Hz

CPD-64ET **CUOCIPASTA TRIFASE LT. 25 VASCA CM. 30,5X33,5X32,7H. RUBINETTO CARICO ACQUA, SFIORATORE + SCARICO A PAVIMENTO. (CESTI ESCLUSI)**

26100430

EN Pasta cooker threephase 25 lts. Tank cm. 30,5x33,5x32,7h. Water loading cock + overflow device and floor draining (BASKETS EXCLUDED)
 • **DE** Nudelkocher Dreiphasig lt. 25. Becken cm. 30,5x33,5x32,7h. Wasserlauf-Hahn, + Überlauf-Vorrichtung und Ablauf am Boden (KORB AUSGESCHLOSSEN) • **FR** Cuiseur à pâtes triphase lt. 25. Cuve cm.30,5x33,5x32,7h. Robinet d'arrivée d'eau trop plein + système de vidange au sol (PANIERES EXCLUS) • **ES** Cuece pasta trifásico lt. 25 - Cuba cm. 30,5x33,5x32,7h. Grifo carga agua + vertedero + descarga a pavimento (CESTAS EXCLUIDAS)
cm. 40x 60x 51h



⚡ 7,8 kW **2.199,00**
 400V~3N 22 / 0,24
 50/60 Hz

COMBINAZIONI

- Combinations / • Zusammenstellungen
- Combinaisons / • Combinación múltiple



MOD. _____
COD. _____

DESCRIZIONE / DESCRIPTION / BEZEICHNUNG / DESCRIPTION / DESCRIPCIÓN
DIMENSIONI / DIMENSIONS / ABMESSUNGEN / DIMENSIONS / DIMENSIONES

POTENZA / POWER / LEISTUNG / PUISSANCE / POTENCIA
VOLTAGGIO / VOLTAGE / SPANNUNG / VOLTAGE / VOLTAJE

⚡ kW kcal/h
⚡ kW V~ Hz

PREZZO / PRICE
PREIS / PRIX / PRECIO
KG / M³



CPAD-64ET
26100435

CUOCIPASTA TRIFASE LT. 25 VASCA CM. 30,5X33,5X32,7H. CARICO ACQUA AUTOMATICO CON SENSORE DI LIVELLO - SFIORATORE + SCARICO A PAVIMENTO (CESTI ESCLUSI)

EN Pasta cooker threephase 25 lts. Tank cm. 30,5x33,5x32,7h. Automatic Water loading with level sensor - overflow device and floor draining (BASKETS EXCLUDED) • **DE** Nudelkocher Dreiphasig lt. 25. Becken cm. 30,5x33,5x32,7h. Automatische Wasser Beladung mit Niveauregulierung + Überlauf-Vorrichtung und Ablauf am Boden (KORB AUSGESCHLOSSEN) • **FR** Cuiseur à pates triphase lt. 25. Cuve cm.30,5x33,5x32,7h. Chargement automatique de l'eau avec sensor de niveau, trop plein Système de vidange au sol (PANIERS EXCLUS) • **ES** Cuece pasta trifásico lt. 25 - Cuba cm. 30,5x33,5x32,7h. Carga automática de agua con sensor de nivel + vertedero + descarga a pavimento. (CESTAS EXCLUIDAS)
cm. 40x 60x 51h



⚡ 7,8 kW **2.659,00**
400V~3N 22 / 0,24
50/60 Hz

COMBINAZIONI

- Combinations / • Zusammenstellungen
- Combinaisons / • Combinación múltiple

1/1	1/2 1/2	1/4 1/4	1/6 1/6	1/6
		1/4 1/4	1/6 1/6	1/2 1/6
			1/6 1/6	1/6

CPD-84ET
28100430

CUOCIPASTA TRIFASE LT. 40 VASCA CM. 30,7X50,9X32,7H. RUBINETTO CARICO ACQUA, SFIORATORE + SCARICO A PAVIMENTO (CESTI ESCLUSI)

EN Pasta cooker threephase 40 lts. Tank cm. 30,7x50,9x32,7h. Water loading tap + overflow device and floor draining (BASKETS EXCLUDED) • **DE** Nudelkocher dreiphasig lt. 40 - Becken cm. 30,7x50,9x32,7h. Wasserlauf-Hahn + Überlauf-Vorrichtung und Ablauf am Boden (KORB AUSGESCHLOSSEN) • **FR** Cuiseur a pates triphase lt. 40 Cuve cm.30,7x50,9x32,7h. Robinet d'arrivée d'eau trop plein + système de vidange au sol (PANIERS EXCLUS) • **ES** Cuece pasta trifásico lt. 40 - Cuba cm. 30,7x50,9x32,7h. Grifo carga agua + vertedero + descarga a pavimento (CESTAS EXCLUIDAS)
cm. 40x 80x 51h



⚡ 13,5 kW **2.694,00**
400V~3N 30 / 0,26
50/60 Hz

COMBINAZIONI

- Combinations / • Zusammenstellungen
- Combinaisons / • Combinación múltiple

1/1	1/2	1/3	1/3	1/6 1/6	1/6 1/6
	1/2	1/3	2/3	1/3	1/6 1/6
		1/3		1/3	1/6 1/6

CPAD-84ET
28100435

CUOCIPASTA TRIFASE LT. 40 VASCA CM. 30,7X50,9X32,7H. CARICO ACQUA AUTOMATICO CON SENSORE DI LIVELLO - SFIORATORE + SCARICO A PAVIMENTO (CESTI ESCLUSI)

EN Pasta cooker threephase 40 lts. Tank cm. 30,7x50,9x32,7h. Automatic Water loading with level sensor - overflow device and floor draining (BASKETS EXCLUDED) • **DE** Nudelkocher dreiphasig lt. 40 - Becken cm. 30,7x50,9x32,7h. Automatische Wasser Beladung mit Niveauregulierung + Überlauf-Vorrichtung und Ablauf am Boden (KORB AUSGESCHLOSSEN) • **FR** Cuiseur a pates triphase lt. 40 Cuve cm.30,7x50,9x32,7h. Chargement automatique de l'eau avec sensor de niveau, trop plein Système de vidange au sol (PANIERS EXCLUS) • **ES** Cuece pasta trifásico lt. 40 - Cuba cm. 30,7x50,9x32,7h. Carga automática de agua con sensor de nivel + vertedero + descarga a pavimento. (CESTAS EXCLUIDAS)
cm. 40x 80x 51h



⚡ 13,5 kW **3.153,00**
400V~3N 30 / 0,26
50/60 Hz

COMBINAZIONI

- Combinations / • Zusammenstellungen
- Combinaisons / • Combinación múltiple

1/1	1/2	1/3	1/3	1/6 1/6	1/6 1/6
	1/2	1/3	2/3	1/3	1/6 1/6
		1/3		1/3	1/6 1/6

SOLLEVATORE CESTI

MOD. _____
COD. _____

DESCRIZIONE/DESCRIPTION/BEZEICHNUNG/DESCRIPTION/DESCRIPCIÓN
DIMENSIONI/DIMENSIONS/ABMESSUNGEN/DIMENSIONS/DIMENSIONES

POTENZA/POWER/LEISTUNG/PUISSANCE/POTENCIA
VOLTAGGIO/VOLTAGE/SPANNUNG/VOLTAGE/VOLTAJE

⚡ kW _____
kcal/h _____
V~ _____
Hz _____

PREZZO/PRICE
PREIS/PRIX/PRECIO
KG / M³



SCCPD-2EM
26140210

SOLLEVATORE CESTI DA AFFIANCARE AI CUOCIPASTA CPD-64, SOLLEVAMENTO AUTOMATICO TEMPORIZZATO O MANUALE, 2 ASTE

EN basket elevator for pasta cooker CPD-64, automatic timed or manual lifting, 2 rods • **DE** heben Korbe für Nudelkocher CPD-64, Timed oder manuelle Heben, 2 Stangen • **FR** soulever des paniers pour cuiseur a pates CPD-64, soulèvement temporisé ou manuel, 2 tiges • **ES** levante cestas para cuece pasta CPD-64, elevación temporizado o manual, 2 barras

cm. 16x 34x 71h

⚡ 0,35 kW _____ **3.239,00**
230V~ _____ 16 / 0,25
50/60 Hz



COMBINAZIONI

- Combinations / • Zusammenstellungen
- Combinaisons / • Combinación múltiple

1/1	1/2	1/4
	1/2	1/4

SCCPD-3EM
28140210

SOLLEVATORE CESTI DA AFFIANCARE AI CUOCIPASTA CPD-84, SOLLEVAMENTO AUTOMATICO TEMPORIZZATO O MANUALE, 3 ASTE

EN basket elevator for pasta cooker CPD-84, automatic timed or manual lifting, 2 rods • **DE** heben Korbe für Nudelkocher CPD-84, Timed oder manuelle Heben, 2 Stangen • **FR** soulever des paniers pour cuiseur a pates CPD-84, soulèvement temporisé ou manuel, 2 tiges • **ES** levante cestas para cuece pasta CPD-84, elevación temporizado o manual, 2 barras

cm. 16x 50x 71h

⚡ 0,525 kW _____ **4.367,00**
230V~ _____ 21 / 0,37
50/60 Hz



COMBINAZIONI

- Combinations / • Zusammenstellungen
- Combinaisons / • Combinación múltiple

1/1	1/2	1/3	1/3	1/6
	1/2	1/3	2/3	1/6
		1/3		1/6

CWKD-64ET
26080431

GRIGLIA CONTACT - COTTURA DIRETTA SU RESISTENZA IN ACCIAIO INOX CM. 27X43 RIBALTABILE

EN CONTACT Grill threephase - rotatable stainless steel grill cm. 27x43 • **DE** Wurstbrater dreiphasig KONTAKT - Drehbaren Heizelement aus Edelstahl cm. 27x43 • **FR** Grillade triphase CONTACT - Grille inox rotatif cm 27x43 • **ES** Parrilla trifásico CONTACT - Parrilla giratoria de acero inox cm 27x43

cm. 40x 60x 30h

⚡ 4,08 kW _____ **2.798,00**
400V~3N _____ 30 / 0,16
50/60 Hz



CWKD-68ET
26080831

GRIGLIA CONTACT - COTTURA DIRETTA SU RESISTENZA IN ACCIAIO INOX CM. 55X43 RIBALTABILE - 2 ZONE COTTURA

EN CONTACT Grill threephase - rotatable stainless steel grill cm. 55x43 - 2 cooking areas • **DE** Wurstbrater dreiphasig KONTAKT - Drehbaren Heizelement aus Edelstahl cm.. 55x43 - 2 Heizzonen • **FR** Grillade triphase CONTACT - Grille inox rotatif cm 55x43 - 2 zones de cuisson • **ES** Parrilla trifásico CONTACT - Parrilla giratoria de acero inox cm 55x43 - 2 zonas de cocción

cm. 80x 60x 30h

⚡ 8,16 kW _____ **3.799,00**
400V~3N _____ 60 / 0,31
50/60 Hz



CWKD-84ET
28080431

GRIGLIA CONTACT - COTTURA DIRETTA SU RESISTENZA IN ACCIAIO INOX CM. 27X63 RIBALTABILE

EN CONTACT Grill threephase - rotatable stainless steel grill cm. 27x63 • **DE** Wurstbrater dreiphasig KONTAKT - Drehbaren Heizelement aus Edelstahl cm. 27x63 • **FR** Grillade triphase CONTACT - Grille inox rotatif cm 27x63 • **ES** Parrilla trifásico CONTACT - Parrilla giratoria de acero inox cm 27x63

cm. 40x 80x 30h

⚡ 5,415 kW _____ **3.272,00**
400V~3N _____ 35 / 0,23
50/60 Hz



FRIGGITRICI ELETTRICHE 60

MOD. _____
COD. _____

DESCRIZIONE/DESCRIPTION/BEZEICHNUNG/DESCRIPTION/DESCRIPCIÓN
DIMENSIONI/DIMENSIONS/ABMESSUNGEN/DIMENSIONS/DIMENSIONES

POTENZA/POWER/LEISTUNG/PUISSANCE/POTENCIA
VOLTAGGIO/VOLTAGE/SPANNUNG/VOLTAGE/VOLTAJE

⚡ kW kcal/h
V~ Hz

PREZZO/PRICE
PREIS/PRIX/PRECIO
KG / M³



F2/8D-64ET FRIGGITRICE TRIFASE LT. 8+8 2 VASCHE CM. 14,8X35X32,7H - 2 CESTI CM. 12X30X15H - FILTRO E COPERCHIO VASCA. PRODUZIONE PATATE: 12 KG/H

26090432

EN Fryer threephase 8+8 lts - 2 Bowls cm. 14,8x35x32,7h - 2 baskets cm. 12x30x15h. Sieve and lid for pan. Production: 12 kg/h • **DE** Friteuse dreiphasig lt. 8+8 - 2 Becken cm. 14,8x35x32,7h - 2 Korb cm. 12x30x15h. Einlegesieb und Deckel für Becken. Pommes frites: 12 kg/h • **FR** Friteuse triphase lt. 8+8 - 2 Cuve cm. 14,8x35x32,7h - 2 Panier cm. 12x30x15h. Filtre, couvercle pour cuve. Production de pommes frites: 12 kg/h • **ES** Freidoras trifásico 8+8 lt. - 2Cuba cm. 14,8x35x32,7h - 2 cesta cm. 12x30x15h. Filtro y tapa para cuba. Prod. patatas: 12 Kg/h
cm. 40x 60x 46h



⚡ 12 kW 2.804,00
400V~3N 30 / 0,23
230V~3
50/60 Hz

F10D-64ET FRIGGITRICE TRIFASE LT. 10 VASCA CM. 22X35X23H - 1 CESTO CM. 20X30X10H - FILTRO E COPERCHIO VASCA. PRODUZIONE PATATE: 10 KG/H

26090430

EN Fryer threephase 10 lts - Bowl cm. 22x35x23h - 1 basket cm. 20x30x10h. Sieve and lid for pan. Production: 10 kg/h • **DE** Friteuse dreiphasig lt. 10 - Becken cm. 22x35x23h - 1 Korb cm. 20x30x10h. Einlegesieb und Deckel für Becken. Pommes frites: 10 kg/h • **FR** Friteuse triphase lt. 10 - Cuve cm. 22x35x23h - 1 Panier cm. 20x30x10h. Filtre, couvercle pour cuve. Production de pommes frites: 10 kg/h • **ES** Freidoras trifásico 10 lt. - Cuba cm. 22x35x23h - 1 cesta cm. 20x30x10h. Filtro y tapa para cuba. Prod. patatas: 10 Kg/h
cm. 40x 60x 39h



⚡ 7,15 kW 1.554,00
400V~3N 20 / 0,24
230V~3
50/60 Hz

F2/10D-66ET FRIGGITRICE TRIFASE LT. 10+10 2 VASCHE CM. 22X35X23H - 2 CESTI CM. 20X30X10H - FILTRO E COPERCHIO VASCA. PRODUZIONE PATATE: 20 KG/H

26090630

EN Fryer threephase 10+10 lts - 2 Bowls cm. 22x35x23h - 2 baskets cm. 20x30x10h. Sieve and lid for pan. Production: 20 kg/h • **DE** Friteuse dreiphasig lt. 10+10 - 2 Becken cm. 22x35x23h - 2 Korb cm. 20x30x10h. Einlegesieb und Deckel für Becken. Pommes frites: 20 kg/h • **FR** Friteuse triphase lt. 10+10 - 2 Cuve cm. 22x35x23h - 2 Panier cm. 20x30x10h. Filtre, couvercle pour cuve. Production de pommes frites: 20 kg/h • **ES** Freidoras trifásico 10+10 lt. - 2Cuba cm. 22x35x23h - 2 cesta cm. 20x30x10h. Filtro y tapa para cuba. Prod. patatas: 20 kg/h
cm. 60x 60x 39h



⚡ 14,3 kW 2.844,00
400V~3N 32 / 0,27
230V~3
50/60 Hz

F18D-64ET FRIGGITRICE TRIFASE LT. 18 VASCA CM. 31X34X33H - 1 CESTO CM. 28X29X15H - FILTRO E COPERCHIO VASCA. PRODUZIONE PATATE: 15 KG/H

26090431

EN Fryer threephase 18 lts - Bowl cm. 31x34x33h - 1 basket cm. 28x29x15h. Sieve and lid for pan. Production: 15 kg/h • **DE** Friteuse dreiphasig lt. 18 - Becken cm. 31x34x33h - 1 Korb cm. 28x29x15h. Einlegesieb und Deckel für Becken. Pommes frites: 15 kg/h • **FR** Friteuse triphase lt. 18 - Cuve cm. 31x34x33h - 1 Panier cm. 28x29x15h. Filtre, couvercle pour cuve. Production de pommes frites: 15 kg/h • **ES** Freidoras trifásico 18 lt. - Cuba cm. 31x34x33h - 1 cesta cm. 28x29x15h. Filtro y tapa para cuba. Prod. patatas: 15 Kg/h
cm. 40x 60x 46h



⚡ 15,9 kW 2.263,00
400V~3N 30 / 0,23
50/60 Hz

F23D-66ET FRIGGITRICE TRIFASE LT. 23 VASCA CM. 50X35X22H - CESTO CM. 46X30X10H - FILTRO E COPERCHIO VASCA.

26090631

EN Fryer threephase 23 lts - Bowls cm. 50x35x24h - Basket cm. 46x30x10h - Sieve and lid for pan. • **DE** Friteuse dreiphasig lt. 23 - Becken cm. 50x35x22h - Körb cm. 46x30x10h - Einlegesieb und Deckel für Becken. • **FR** Friteuse triphase lt. 23 - Cuve cm. 50x35x22h - Panier cm 46x30x10h - Filtre, couvercle pour cuve. • **ES** Freidoras trifásico 23 lt. cuba cm. 50x35x22h - Cesta cm. 46x30x10h - Filtro y tapa para cuba.
cm. 60x 60x 39h



⚡ 14,3 kW 2.293,00
400V~3N 31 / 0,27
50/60 Hz

FTLD-64ET FRY-TOP ELETTRICO LISCIO, PIASTRA CM.35,5X55

26060431

EN Electric Fry-top smooth griddle, plate cm.35,5x55 • **DE** Griddleplatte elektrische glatt, platte cm.35,5x55 • **FR** Plaque électriques lisse, plaque cm.35,5x55 • **ES** Fry-top eléctrico liso, plancha cm.35,5x55
cm. 40x 60x 22h



⚡ 4,5 kW 1.357,00
400V~3N 30 / 0,13
230V~3
50/60 Hz



FRY-TOP ELETTRICI 60

MOD. _____
COD. _____

DESCRIZIONE/DESCRIPTION/BEZEICHNUNG/DESCRIPTION/DESCRIPCIÓN
DIMENSIONI/DIMENSIONS/ABMESSUNGEN/DIMENSIONS/DIMENSIONES

POTENZA/POWER/LEISTUNG/PUISSANCE/POTENCIA
VOLTAGGIO/VOLTAGE/SPANNUNG/VOLTAGE/VOLTAJE

⚡ kW kcal/h
V~ Hz

PREZZO/PRICE
PREIS/PRIX/PRECIO
KG / M³



FTLD-64ETS FRY-TOP ELETTRICO LISCIO CROMATO SUPERCHROME (MOCA APPROVED), PIASTRA CM.35,5X55

26060434

EN Electric Fry-top smooth chromed griddle SUPERCHROME (Moca Approved), plate cm.35,5x55 • **DE** Griddleplatte elektrische glatt hartverchromt SUPERCHROME (Moca Approved), platte cm.35,5x55 • **FR** Plaque électriques lisse chromée SUPERCHROME (Moca Approved), plaque cm.35,5x55 • **ES** Fry-top eléctrico liso cromado SUPERCHROME (Moca Approved), plancha cm.35,5x55
cm. 40x 60x 22h



⚡ 4,5 kW **1.696,00**
400V~3N 30 / 0,13
230V~3
50/60 Hz



FTRD-64ET FRY-TOP ELETTRICO RIGATO, PIASTRA CM.35,5X55

26060433

EN Electric Fry-top grooved griddle, plate cm.35,5x55 • **DE** Griddleplatte elektrische gerillt, platte cm.35,5x55 • **FR** Plaque électriques nervurée, plaque cm.35,5x55 • **ES** Fry-top eléctrico estriado, plancha cm.35,5x55
cm. 40x 60x 22h



⚡ 4,5 kW **1.361,00**
400V~3N 30 / 0,13
230V~3
50/60 Hz



FTRD-64ETS FRY-TOP ELETTRICO RIGATO CROMATO SUPERCHROME (MOCA APPROVED), PIASTRA CM.35,5X55

26060436

EN Electric Fry-top grooved chromed griddle SUPERCHROME (Moca Approved), plate cm.35,5x55 • **DE** Griddleplatte elektrische gerillt hartverchromt SUPERCHROME (Moca Approved), platte cm.35,5x55 • **FR** Plaque électriques nervurée chromée SUPERCHROME (Moca Approved), plaque cm.35,5x55 • **ES** Fry-top eléctrico estriado cromado SUPERCHROME (Moca Approved), plancha cm.35,5x55
cm. 40x 60x 22h



⚡ 4,5 kW **1.769,00**
400V~3N 30 / 0,13
230V~3
50/60 Hz



FTLD-66ET FRY-TOP ELETTRICO LISCIO, PIASTRA CM.55,5X55 - 2 ZONE DI COTTURA

26060631

EN Electric Fry-top smooth griddle, plate cm.55,5x55 - 2 cooking areas • **DE** Griddleplatte elektrische glatt, platte cm.55,5x55 - 2 Heizzonen • **FR** Plaque électriques lisse, plaque cm.55,5x55 - 2 zones de cuisson • **ES** Fry-top eléctrico liso, plancha cm.55,5x55 - 2 zonas de cocción
cm. 60x 60x 22h



⚡ 6 kW **1.732,00**
400V~3N 45 / 0,22
230V~3
230V~
50/60 Hz



FTLD-66ETS FRY-TOP ELETTRICO LISCIO CROMATO SUPERCHROME (MOCA APPROVED), PIASTRA CM.55,5X55 - 2 ZONE DI COTTURA

26060634

EN Electric Fry-top smooth chromed griddle SUPERCHROME (Moca Approved), plate cm.55,5x55 - 2 cooking areas • **DE** Griddleplatte elektrische glatt hartverchromt SUPERCHROME (Moca Approved), platte cm.55,5x55 - 2 Heizzonen • **FR** Plaque électriques lisse chromée SUPERCHROME (Moca Approved), plaque cm.55,5x55 - 2 zones de cuisson • **ES** Fry-top eléctrico liso cromado SUPERCHROME (Moca Approved), plancha cm.55,5x55 - 2 zonas de cocción
cm. 60x 60x 22h



⚡ 6 kW **2.269,00**
400V~3N 45 / 0,22
230V~3
230V~
50/60 Hz



FTLRD-66ET FRY-TOP ELETTRICO 1/2 RIGATO + 1/2 LISCIO, PIASTRA CM.55,5X55 - 2 ZONE DI COTTURA

26060632

EN Electric Fry-top 1/2 grooved + 1/2 smooth, plate cm.55,5x55 - 2 cooking areas • **DE** Griddleplatte elektrische 1/2 gerillt + 1/2 glatt, platte cm.55,5x55 - 2 Heizzonen • **FR** Plaque électriques 1/2 nervurée + 1/2 lisse, plaque cm.55,5x55 - 2 zones de cuisson • **ES** Fry-top eléctrico 1/2 estriado + 1/2 liso, plancha cm.55,5x55 - 2 zonas de cocción
cm. 60x 60x 22h



⚡ 6 kW **1.811,00**
400V~3N 45 / 0,22
230V~3
230V~
50/60 Hz



FRY-TOP ELETTRICI 60

MOD. _____
COD. _____

DESCRIZIONE/DESCRIPTION/BEZEICHNUNG/DESCRIPTION/DESCRIPCIÓN
DIMENSIONI/DIMENSIONS/ABMESSUNGEN/DIMENSIONS/DIMENSIONES

POTENZA/POWER/LEISTUNG/PUISSANCE/POTENCIA
VOLTAGGIO/VOLTAGE/SPANNUNG/VOLTAGE/VOLTAJE

⚡ kW
kcal/h

⚡ kW
V~
Hz

PREZZO/PRICE
PREIS/PRIX/PRECIO
KG / M³



FREEBLOCK
FREELOTUS

FTLRD-66ETS FRY-TOP ELETTRICO 1/2 RIGATO + 1/2 LISCIO CROMATO SUPERCHROME (MOCA APPROVED), PIASTRA CM.55,5X55 - 2 ZONE DI COTTURA

26060635

EN Electric Fry-top 1/2 grooved + 1/2 smooth chromed griddle SUPERCHROME (Moca Approved), plate cm.55,5x55 - 2 cooking areas
 • **DE** Griddleplatte elektrische 1/2 gerillt + 1/2 glatt hartverchromt SUPERCHROME (Moca Approved), platte cm.55,5x55 - 2 Heizzonen
 • **FR** Plaque électriques 1/2 nervurée + 1/2 lisse chromée SUPERCHROME (Moca Approved), plaque cm.55,5x55 - 2 zones de cuisson
 • **ES** Fry-top eléctrico 1/2 estriado + 1/2 liso cromado SUPERCHROME (Moca Approved), plancha cm.55,5x55 - 2 zonas de cocción
cm. 60x 60x 22h



⚡ 6 kW
400V~3N
230V~3
230V~
50/60 Hz

2.349,00
45 / 0,22



FTRD-66ET FRY-TOP ELETTRICO RIGATO, PIASTRA CM.55,5X55 - 2 ZONE DI COTTURA

26060633

EN Electric Fry-top grooved griddle, plate cm.55,5x55 - 2 cooking areas
 • **DE** Griddleplatte elektrische gerillt, platte cm.55,5x55 - 2 Heizzonen
 • **FR** Plaque électriques nervurée, plaque cm.55,5x55 - 2 zones de cuisson
 • **ES** Fry-top eléctrico estriado, plancha cm.55,5x55 - 2 zonas de cocción
cm. 60x 60x 22h



⚡ 6 kW
400V~3N
230V~3
230V~
50/60 Hz

1.858,00
45 / 0,22



FTRD-66ETS FRY-TOP ELETTRICO RIGATO CROMATO SUPERCHROME (MOCA APPROVED), PIASTRA CM.55,5X55 - 2 ZONE DI COTTURA

26060636

EN Electric Fry-top grooved chromed griddle SUPERCHROME (Moca Approved), plate cm.55,5x55 - 2 cooking areas
 • **DE** Griddleplatte elektrische gerillt hartverchromt SUPERCHROME (Moca Approved), platte cm.55,5x55 - 2 Heizzonen
 • **FR** Plaque électriques nervurée chromée SUPERCHROME (Moca Approved), plaque cm.55,5x55 - 2 zones de cuisson
 • **ES** Fry-top eléctrico estriado cromado SUPERCHROME (Moca Approved), plancha cm.55,5x55 - 2 zonas de cocción
cm. 60x 60x 22h



⚡ 6 kW
400V~3N
230V~3
230V~
50/60 Hz

2.394,00
45 / 0,22



FTLD-68ET FRY-TOP ELETTRICO LISCIO, PIASTRA CM.75,5X55 - 2 ZONE DI COTTURA

26060831

EN Electric Fry-top smooth griddle, plate cm.75,5x55 - 2 cooking areas
 • **DE** Griddleplatte elektrische glatt, platte cm.75,5x55 - 2 Heizzonen
 • **FR** Plaque électriques lisse, plaque cm.75,5x55 - 2 zones de cuisson
 • **ES** Fry-top eléctrico liso, plancha cm.75,5x55 - 2 zonas de cocción
cm. 80x 60x 22h



⚡ 9 kW
400V~3N
230V~3
50/60 Hz

2.126,00
60 / 0,32



FTLD-68ETS FRY-TOP ELETTRICO LISCIO CROMATO SUPERCHROME (MOCA APPROVED), PIASTRA CM.75,5X55 - 2 ZONE DI COTTURA

26060834

EN Electric Fry-top smooth chromed griddle SUPERCHROME (Moca Approved), plate cm.75,5x55 - 2 cooking areas
 • **DE** Griddleplatte elektrische glatt hartverchromt SUPERCHROME (Moca Approved), platte cm.75,5x55 - 2 Heizzonen
 • **FR** Plaque électriques lisse chromée SUPERCHROME (Moca Approved), plaque cm.75,5x55 - 2 zones de cuisson
 • **ES** Fry-top eléctrico liso cromado SUPERCHROME (Moca Approved), plancha cm.75,5x55 - 2 zonas de cocción
cm. 80x 60x 22h



⚡ 9 kW
400V~3N
230V~3
50/60 Hz

2.879,00
60 / 0,32

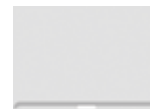

FTLRD-68ET FRY-TOP ELETTRICO 1/2 RIGATO + 1/2 LISCIO, PIASTRA CM.75,5X55 - 2 ZONE DI COTTURA

26060832

EN Electric Fry-top 1/2 grooved + 1/2 smooth, plate cm.75,5x55 - 2 cooking areas
 • **DE** Griddleplatte elektrische 1/2 gerillt + 1/2 glatt, platte cm.75,5x55 - 2 Heizzonen
 • **FR** Plaque électriques 1/2 nervurée + 1/2 lisse, plaque cm.75,5x55 - 2 zones de cuisson
 • **ES** Fry-top eléctrico 1/2 estriado + 1/2 liso, plancha cm.75,5x55 - 2 zonas de cocción
cm. 80x 60x 22h



⚡ 9 kW
400V~3N
230V~3
50/60 Hz

2.202,00
60 / 0,32



FRY-TOP ELETTRICI 60

MOD. _____
COD. _____

DESCRIZIONE/DESCRIPTION/BEZEICHNUNG/DESCRIPTION/DESCRIPCIÓN
DIMENSIONI/DIMENSIONS/ABMESSUNGEN/DIMENSIONS/DIMENSIONES

POTENZA/POWER/LEISTUNG/PUISSANCE/POTENCIA
VOLTAGGIO/VOLTAGE/SPANNUNG/VOLTAGE/VOLTAJE

⚡ kW kcal/h
V~ Hz

PREZZO/PRICE
PREIS/PRIX/PRECIO
KG / M³



FTRD-68ETS FRY-TOP ELETTRICO 1/2 RIGATO + 1/2 LISCIO CROMATO SUPERCHROME (MOCA APPROVED), PIASTRA CM.75,5X55 - 2 ZONE DI COTTURA

26060835

EN Electric Fry-top 1/2 grooved + 1/2 smooth chromed griddle SUPERCHROME (Moca Approved), plate cm.75,5x55 - 2 cooking areas
 • **DE** Griddleplatte elektrische 1/2 gerillt + 1/2 glatt hartverchromt SUPERCHROME (Moca Approved), platte cm.75,5x55 - 2 Heizzonen
 • **FR** Plaque électriques 1/2 nervurée + 1/2 lisse chromée SUPERCHROME (Moca Approved), plaque cm.75,5x55 - 2 zones de cuisson
 • **ES** Fry-top eléctrico 1/2 estriado + 1/2 liso cromado SUPERCHROME (Moca Approved), plancha cm.75,5x55 - 2 zonas de cocción
cm. 80x 60x 22h



⚡ 9 kW **3.036,00**
400V~3N 60 / 0,32
230V~3
50/60 Hz



FTRD-68ET FRY-TOP ELETTRICO RIGATO, PIASTRA CM.75,5X55 - 2 ZONE DI COTTURA

26060833

EN Electric Fry-top grooved griddle, plate cm.55,5x55 - 2 cooking areas
 • **DE** Griddleplatte elektrische gerillt, platte cm.55,5x55 - 2 Heizzonen
 • **FR** Plaque électriques nervurée, plaque cm.55,5x55 - 2 zones de cuisson
 • **ES** Fry-top eléctrico estriado, plancha cm.55,5x55 - 2 zonas de cocción
cm. 80x 60x 22h



⚡ 9 kW **2.252,00**
400V~3N 60 / 0,32
230V~3
50/60 Hz



FTRD-68ETS FRY-TOP ELETTRICO RIGATO CROMATO SUPERCHROME (MOCA APPROVED), PIASTRA CM.75,5X55 - 2 ZONE DI COTTURA

26060836

EN Electric Fry-top grooved chromed griddle SUPERCHROME (Moca Approved), plate cm.55,5x55 - 2 cooking areas
 • **DE** Griddleplatte elektrische gerillt hartverchromt SUPERCHROME (Moca Approved), platte cm.55,5x55 - 2 Heizzonen
 • **FR** Plaque électriques nervurée chromée SUPERCHROME (Moca Approved), plaque cm.55,5x55 - 2 zones de cuisson
 • **ES** Fry-top eléctrico estriado cromado SUPERCHROME (Moca Approved), plancha cm.55,5x55 - 2 zonas de cocción
cm. 80x 60x 22h



⚡ 9 kW **3.004,00**
400V~3N 60 / 0,32
230V~3
50/60 Hz



FTLD-84ET FRY-TOP ELETTRICO LISCIO, PIASTRA CM.36X68

28060431

EN Electric Fry-top smooth griddle, plate cm.36x68
 • **DE** Griddleplatte elektrische glatt, platte cm.36x68
 • **FR** Plaque électriques lisse, plaque cm.36x68
 • **ES** Fry-top eléctrico liso, plancha cm.36x68
cm. 40x 80x 22h



⚡ 7,5 kW **2.277,00**
400V~3N 45 / 0,23
50/60 Hz



FTLD-84ETS FRY-TOP ELETTRICO LISCIO CROMATO SUPERCHROME (MOCA APPROVED), PIASTRA CM.36X68

28060434

EN Electric Fry-top smooth chromed griddle SUPERCHROME (Moca Approved), plate cm.36x68
 • **DE** Griddleplatte elektrische glatt hartverchromt SUPERCHROME (Moca Approved), platte cm.36x68
 • **FR** Plaque électriques lisse chromée SUPERCHROME (Moca Approved), plaque cm.36x68
 • **ES** Fry-top eléctrico liso cromado SUPERCHROME (Moca Approved), plancha cm.36x68
cm. 40x 80x 22h



⚡ 7,5 kW **2.853,00**
400V~3N 45 / 0,23
50/60 Hz



FTLD-88ET FRY-TOP ELETTRICO LISCIO, PIASTRA CM.76X68 - 2 ZONE DI COTTURA

28060831

EN Electric Fry-top smooth griddle, plate cm.76x68 - 2 cooking areas
 • **DE** Griddleplatte elektrische glatt, platte cm.76x68 - 2 Heizzonen
 • **FR** Plaque électriques lisse, plaque cm.76x68 - 2 zones de cuisson
 • **ES** Fry-top eléctrico liso, plancha cm.76x68 - 2 zonas de cocción
cm. 80x 80x 22h



⚡ 15 kW **3.372,00**
400V~3N 90 / 0,44
50/60 Hz

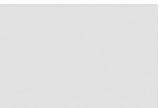

FRY-TOP ELETTRICI 80

MOD. _____
COD. _____

DESCRIZIONE/DESCRIPTION/BEZEICHNUNG/DESCRIPTION/DESCRIPCIÓN
DIMENSIONI/DIMENSIONS/ABMESSUNGEN/DIMENSIONS/DIMENSIONES

POTENZA/POWER/LEISTUNG/PUISSANCE/POTENCIA
VOLTAGGIO/VOLTAGE/SPANNUNG/VOLTAGE/VOLTAJE

⚡ kW _____
kcal/h _____
V~ _____
Hz _____

PREZZO/PRICE
PREIS/PRIX/PRECIO
KG / M³



FTLD-88ETS **FRY-TOP ELETTRICO LISCIO CROMATO SUPERCHROME (MOCA APPROVED), PIASTRA CM.76X68 - 2 ZONE DI COTTURA**
28060834
EN Electric Fry-top smooth chromed griddle SUPERCHROME (Moca Approved), plate cm.76x68 - 2 cooking areas • **DE** Griddleplatte elektrische glatt hartverchromt SUPERCHROME (Moca Approved), platte cm.76x68 - 2 Heizzonen • **FR** Plaque électriques lisse chromée SUPERCHROME (Moca Approved), plaque cm.76x68 - 2 zones de cuisson • **ES** Fry-top eléctrico liso cromado SUPERCHROME (Moca Approved), plancha cm.76x68 - 2 zonas de cocción
cm. 80x 80x 22h



⚡ 15 kW _____ **4.140,00**
400V~3N _____ 90 / 0,44
50/60 Hz _____

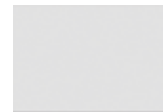

FTLRD-88ET **FRY-TOP ELETTRICO 1/2 RIGATO + 1/2 LISCIO, PIASTRA CM.76X68 - 2 ZONE DI COTTURA**
28060832
EN Electric Fry-top 1/2 grooved + 1/2 smooth, plate cm.76x68 - 2 cooking areas • **DE** Griddleplatte elektrische 1/2 gerillt + 1/2 glatt, platte cm.76x68 - 2 Heizzonen • **FR** Plaque électriques 1/2 nervurée + 1/2 lisse, plaque cm.76x68 - 2 zones de cuisson • **ES** Fry-top eléctrico 1/2 estriado + 1/2 liso, plancha cm.76x68 - 2 zonas de cocción
cm. 80x 80x 22h



⚡ 15 kW _____ **3.541,00**
400V~3N _____ 90 / 0,44
50/60 Hz _____



FTLRD-88ETS **FRY-TOP ELETTRICO 1/2 RIGATO + 1/2 LISCIO CROMATO SUPERCHROME (MOCA APPROVED), PIASTRA CM.76X68 - 2 ZONE DI COTTURA**
28060835
EN Electric Fry-top 1/2 grooved + 1/2 smooth chromed griddle SUPERCHROME (Moca Approved), plate cm.76x68 - 2 cooking areas • **DE** Griddleplatte elektrische 1/2 gerillt + 1/2 glatt hartverchromt SUPERCHROME (Moca Approved), platte cm.76x68 - 2 Heizzonen • **FR** Plaque électriques 1/2 nervurée + 1/2 lisse chromée SUPERCHROME (Moca Approved), plaque cm.76x68 - 2 zones de cuisson • **ES** Fry-top eléctrico 1/2 estriado + 1/2 liso cromado SUPERCHROME (Moca Approved), plancha cm.76x68 - 2 zonas de cocción
cm. 80x 80x 22h

⚡ 15 kW _____ **4.307,00**
400V~3N _____ 90 / 0,44
50/60 Hz _____



PCD-64ET **PIANO COTTURA TRIFASE N. 2 PIASTRE**
26030430
EN Boiling unit - N. 2 plates • **DE** Kochplatte - N. 2 Kochplatten • **FR** Rechaud - N. 2 plaques • **ES** Sobre de cocción - N. 2 planchas
cm. 40x 60x 5h



⚡ 5,2 kW _____ **715,00**
400V~2N _____ 19 / 0,13
230V~3 _____
230V~ _____
50/60 Hz _____

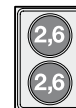

PCD-68ET **PIANO COTTURA TRIFASE N. 4 PIASTRE**
26030830
EN Boiling unit - N. 4 plates • **DE** Kochplatte - N. 4 Kochplatten • **FR** Rechaud - N. 4 plaques • **ES** Sobre de cocción - N. 4 planchas
cm. 80x 60x 5h

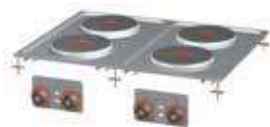

⚡ 10,4 kW _____ **1.103,00**
400V~3N _____ 38 / 0,32
230V~3 _____
50/60 Hz _____

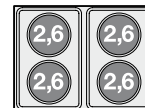

PCQD-64ET **PIANO COTTURA TRIFASE - N. 2 PIASTRE QUADRE**
26030431
EN Boiling unit threephase - N. 2 square plates • **DE** Kochplatte dreiphasig - N. 2 quadratischen Platten • **FR** Rechaud électriques - N. 2 plaques carrés • **ES** Sobre de cocción trifásico - N. 2 planchas cuadradas
cm. 40x 60x 5h



⚡ 5,2 kW _____ **1.415,00**
400V~2N _____ 19 / 0,13
230V~3 _____
230V~ _____
50/60 Hz _____

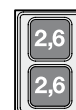

PIANI COTTURA ELETTRICI 60

MOD. _____
COD. _____

DESCRIZIONE/DESCRIPTION/BEZEICHNUNG/DESCRIPTION/DESCRIPCIÓN
DIMENSIONI/DIMENSIONS/ABMESSUNGEN/DIMENSIONS/DIMENSIONES

POTENZA/POWER/LEISTUNG/PUISSANCE/POTENCIA
VOLTAGGIO/VOLTAGE/SPANNUNG/VOLTAGE/VOLTAJE

⚡ kW _____
kcal/h _____
V~ _____
Hz _____

PREZZO/PRICE
PREIS/PRIX/PRECIO
KG / M³



PCQD-68ET PIANO COTTURA TRIFASE - N. 4 PIASTRE QUADRE

26030831 **EN** Boiling unit threephase - N. 4 square plates • **DE** Kochplatte dreiphasig - N. 4 quadratischen Platten • **FR** Rechaud électriques - N. 4 plaques carrés • **ES** Sobre de cocción trifásico - N. 4 planchas cuadradas
cm. 80x 60x 5h



⚡ 10,4 kW _____ **2.480,00**
400V~3N _____ 38 / 0,32
230V~3 _____
50/60 Hz _____

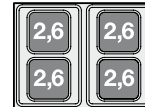

PCQD-84ET PIANO COTTURA TRIFASE - N. 2 PIASTRE QUADRE

28030431 **EN** Boiling unit threephase - N. 2 square plates • **DE** Kochplatte dreiphasig - N. 2 quadratischen Platten • **FR** Rechaud électriques - N. 2 plaques carrés • **ES** Sobre de cocción trifásico - N. 2 planchas cuadradas
cm. 40x 80x 5h



⚡ 8 kW _____ **1.984,00**
400V~2N _____ 24 / 0,23
230V~3 _____
230V~ _____
50/60 Hz _____



PCQD-88ET PIANO COTTURA TRIFASE - N. 4 PIASTRE QUADRE

28030831 **EN** Boiling unit threephase - N. 4 square plates • **DE** Kochplatte dreiphasig - N. 4 quadratischen Platten • **FR** Rechaud électriques - N. 4 plaques carrés • **ES** Sobre de cocción trifásico - N. 4 planchas cuadradas
cm. 80x 80x 5h



⚡ 16 kW _____ **3.665,00**
400V~3N _____ 48 / 0,44
50/60 Hz _____



PCCD-64ET PIANO COTTURA VETROCERAMICA TRIFASE - N. 2 ZONE - VETRO CM.35X57

26030432 **EN** Ceramic glass boiling unit - n. 2 zones - glass cm.35x57 • **DE** Ceran-Kochplatte dreiphasig - 2 zonen - Glas 35x57 cm • **FR** Plan de cuisson à vitroceramique triphasé N. 2 zones - Verre cm.35x57 • **ES** Sobre de cocción trifásico vitrocerámica - 2 zonas - vidrio cm.35x57
cm. 40x 60x 5h



⚡ 5 kW _____ **1.518,00**
400V~2N _____ 12 / 0,13
230V~3 _____
230V~ _____
50/60 Hz _____

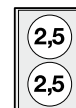

PCCD-68ET PIANO COTTURA VETROCERAMICA TRIFASE - N. 4 ZONE - VETRO CM.75X57

26030832 **EN** Ceramic glass boiling unit - n. 4 zones - glass cm.75x57 • **DE** Ceran-Kochplatte dreiphasig - 4 zonen - Glas 75x57 cm • **FR** Plan de cuisson à vitroceramique triphasé N. 4 zones - Verre cm.75x57 • **ES** Sobre de cocción trifásico vitrocerámica - 4 zonas - vidrio cm.75x57
cm. 80x 60x 5h



⚡ 10 kW _____ **2.265,00**
400V~3N _____ 40 / 0,32
230V~3 _____
50/60 Hz _____

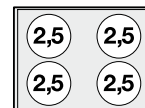

PIANI COTTURA ELETTRICI 80

MOD. _____
COD. _____

DESCRIZIONE/DESCRIPTION/BEZEICHNUNG/DESCRIPTION/DESCRIPCIÓN
DIMENSIONI/DIMENSIONS/ABMESSUNGEN/DIMENSIONS/DIMENSIONES

POTENZA/POWER/LEISTUNG/PUISSANCE/POTENCIA
VOLTAGGIO/VOLTAGE/SPANNUNG/VOLTAGE/VOLTAJE

⚡ kW _____
kcal/h _____
V~ _____
Hz _____

PREZZO/PRICE
PREIS/PRIX/PRECIO
KG / M³



FREEBLOCK
FREELOTUS

PCCD-84ET PIANO COTTURA VETROCERAMICA TRIFASE - N. 2 ZONE -
28030432 VETRO CM.35X77

EN Ceramic glass boiling unit - n. 2 zones - glass cm.35x77 • **DE** Ceran-Kochplatte dreiphasig - 2 zonen - Glas 35x77 cm • **FR** Plan de cuisson à vitroceramique triphasé N. 2 zones - Verre cm.35x77 • **ES** Sobre de cocción trifásico vitrocerámica - 2 zonas - vidrio cm.35x77
cm. 40x 80x 5h



⚡ 6,8 kW _____ **2.484,00**
400V~2N _____ 24 / 0,23
230V~3
230V~
50/60 Hz

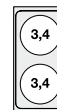

PCCD-88ET PIANO COTTURA VETROCERAMICA TRIFASE - N. 4 ZONE -
28030832 VETRO CM.75X77

EN Ceramic glass boiling unit - n. 4 zones - glass cm.75x77 • **DE** Ceran-Kochplatte dreiphasig - 4 zonen - Glas 75x77 cm • **FR** Plan de cuisson à vitroceramique triphasé N. 4 zones - Verre cm.75x77 • **ES** Sobre de cocción trifásico vitrocerámica - 4 zonas - vidrio cm.75x77
cm. 80x 80x 5h



⚡ 13,6 kW _____ **4.351,00**
400V~3N _____ 48 / 0,44
230V~3
50/60 Hz

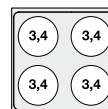

PCID-44ET PIANO COTTURA INDUZIONE TRIFASE - N. 1 ZONA - VETRO
24030433 CM.35X35 (NON POSIZIONARE SU FORNI O CASSETTIERE)

EN Three-phase induction cooking - 1 zone - glass cm.35x35 (do not place on ovens or drawers) • **DE** Induktions-Kochplatte dreiphasig - 1 zone - Glas 35x35 cm (nicht Platz auf Öfen oder Schubladen) • **FR** Plan de cuisson à induction triphasé N. 1 zone - Verre cm.35x35 (ne placez pas sur des fours ou des tiroirs) • **ES** Encimera inducción trifásica - 1 zona - Vidrio cm.35x35 (No coloque en los hornos o en los cajones)
cm. 40x 40x 31h



⚡ 5 kW _____ **4.974,00**
400V~3 _____ 18 / 0,17
50/60 Hz

PCID-64ET PIANO COTTURA INDUZIONE TRIFASE - N. 2 ZONE - VETRO
26030433 CM.35X57 (NON POSIZIONARE SU FORNI O CASSETTIERE)

EN Three-phase induction cooking - 2 zones - glass cm.35x57 (do not place on ovens or drawers) • **DE** Induktions-Kochplatte dreiphasig - 2 zonen - Glas 35x57 cm (nicht Platz auf Öfen oder Schubladen) • **FR** Plan de cuisson à induction triphasé N. 2 zones - Verre cm.35x57 (ne placez pas sur des fours ou des tiroirs) • **ES** Encimera inducción trifásica - 2 zonas - Vidrio cm.35x57 (No coloque en los hornos o en los cajones)
cm. 40x 60x 31h



⚡ 10 kW _____ **7.738,00**
400V~3 _____ 20 / 0,17
50/60 Hz

PIANI COTTURA A INDUZIONE 80

MOD. _____
COD. _____

DESCRIZIONE/DESCRIPTION/BEZEICHNUNG/DESCRIPTION/DESCRIPCIÓN
DIMENSIONI/DIMENSIONS/ABMESSUNGEN/DIMENSIONS/DIMENSIONES

POTENZA/POWER/LEISTUNG/PUISSANCE/POTENCIA
VOLTAGGIO/VOLTAGE/SPANNUNG/VOLTAGE/VOLTAJE

$\frac{kW}{kcal/h}$ $\frac{kW}{V\sim}$
Hz

PREZZO/PRICE
PREIS/PRIX/PRECIO
KG / M³



PCID-84ET
28030433

PIANO COTTURA INDUZIONE TRIFASE - N. 2 ZONE - VETRO CM.35X77 (NON POSIZIONARE SU FORNI O CASSETTIERE)

EN Three-phase induction cooking - 2 zones - glass cm.35x77 (do not place on ovens or drawers) • **DE** Induktions-Kochplatte dreiphasig - 2 zonen - Glas 35x77 cm (nicht Platz auf Öfen oder Schubladen) • **FR** Plan de cuisson à induction triphasé N. 2 zones - Verre cm.35x77 (ne placez pas sur des fours ou des tiroirs) • **ES** Encimera inducción trifásica - 2 zonas - Vidrio cm.35x77 (No coloque en los hornos o en los cajones)
cm. 40x 80x 31h



$\frac{10 kW}{400V\sim3}$ **7.981,00**
50/60 Hz 25 / 0,23

PCID-68ET
26030833

PIANO COTTURA INDUZIONE TRIFASE - N. 4 ZONE - VETRO CM.75X57 (NON POSIZIONARE SU FORNI O CASSETTIERE)

EN Three-phase induction cooking - 4 zones - glass cm.75x57 (do not place on ovens or drawers) • **DE** Induktions-Kochplatte dreiphasig - 4 zonen - Glas 75x57 cm (nicht Platz auf Öfen oder Schubladen) • **FR** Plan de cuisson à induction triphasé N. 4 zones - Verre cm.75x57 (ne placez pas sur des fours ou des tiroirs) • **ES** Encimera inducción trifásica - 4 zonas - Vidrio cm.75x57 (No coloque en los hornos o en los cajones)
cm. 80x 60x 31h

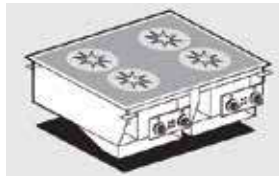

$\frac{20 kW}{400V\sim3}$ **14.492,00**
50/60 Hz 40 / 0,32

PCID-88ET
28030833

PIANO COTTURA INDUZIONE TRIFASE - N. 4 ZONE - VETRO CM.75X77 (NON POSIZIONARE SU FORNI O CASSETTIERE)

EN Three-phase induction cooking - 4 zones - glass cm.75x77 (do not place on ovens or drawers) • **DE** Induktions-Kochplatte dreiphasig - 4 zonen - Glas 75x77 cm (nicht Platz auf Öfen oder Schubladen) • **FR** Plan de cuisson à induction triphasé N. 4 zones - Verre cm.75x77 (ne placez pas sur des fours ou des tiroirs) • **ES** Encimera inducción trifásica - 4 zonas - Vidrio cm.75x77 (No coloque en los hornos o en los cajones)
cm. 80x 80x 31h



$\frac{20 kW}{400V\sim3}$ **15.320,00**
50/60 Hz 50 / 0,44

PIANI COTTURA A INDUZIONE 60

MOD. _____
COD. _____

DESCRIZIONE/DESCRIPTION/BEZEICHNUNG/DESCRIPTION/DESCRIPCIÓN
DIMENSIONI/DIMENSIONS/ABMESSUNGEN/DIMENSIONS/DIMENSIONES

POTENZA/POWER/LEISTUNG/PUISSANCE/POTENCIA
VOLTAGGIO/VOLTAGE/SPANNUNG/VOLTAGE/VOLTAJE

⚡ kW kcal/h
400V~3
50/60 Hz

PREZZO/PRICE
PREIS/PRIX/PRECIO
KG / M³



FREEBLOCK
FREELOTUS

PCIWD-64ET PIANO COTTURA INDUZIONE TRIFASE "WOK" - N. 1
26030434 **ZONA - VETRO Ø 30 CM. (NON POSIZIONARE SU FORNI O CASSETTIERE)**

EN Three-phase induction cooking "WOK" - 1 zone - glass Ø 30 cm (do not place on ovens or drawers) • **DE** Induktions-Kochplatte "WOK" dreiphasig - 1 zonen - Glas Ø 30 cm (nicht Platz auf Öfen oder Schubladen) • **FR** Plan de cuisson à induction "WOK" triphasé N. 1 zone - Verre cm Ø 30 (ne placez pas sur des fours ou des tiroirs) • **ES** Encimera inducción "WOK" trifásica - 1 zona - Vidrio Ø 30 cm (No coloque en los hornos o en los cajones)
cm. 40x 60x 31h

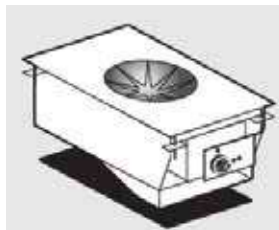

⚡ 5 kW **5.819,00**
400V~3 20 / 0,17
50/60 Hz

TPD-68ET TUTTA PIASTRA PIASTRA CM. 70X50 - 4 ZONE

26120830

EN Solid top - Plate cm. 70x50- 4 zones • **DE** Kochplatten - Platte cm. 70x50 - 4 zonen • **FR** Toute plaque - Plaque cm. 70x50 - 4 zones • **ES** Placa de cocción - Placa cm. 70x50 - 4 zonas
cm. 80x 60x 24h



⚡ 10 kW **3.218,00**
400V~3N 80 / 0,32
50/60 Hz

TPD-84ET TUTTA PIASTRA PIASTRA CM. 30X68 - 2 ZONE

28120430

EN Solid top - Plate cm. 30x68- 2 zones • **DE** Kochplatten - Platte cm. 30x68 - 2 zonen • **FR** Toute plaque - Plaque cm. 30x68 - 2 zones • **ES** Placa de cocción - Placa cm. 30x68 - 2 zonas
cm. 40x 80x 24h



⚡ 5 kW **2.236,00**
400V~3N 50 / 0,23
50/60 Hz

TPD-88ET TUTTA PIASTRA PIASTRA CM. 70X68 - 4 ZONE

28120830

EN Solid top - Plate cm. 70x68- 4 zones • **DE** Kochplatten - Platte cm. 70x68 - 4 zonen • **FR** Toute plaque - Plaque cm. 70x68 - 4 zones • **ES** Placa de cocción - Placa cm. 70x68 - 4 zonas
cm. 80x 80x 24h



⚡ 13,6 kW **4.012,00**
400V~3N 93 / 0,44
50/60 Hz

FSD-78ET FORNO ELETTRICO STATICO CM. 67X55X34H, TEMP: 50÷300°C, CON 1 GRIGLIA CM.65X53 GN2/1

26500830

EN Traditional electric oven cm. 67x55x34h, temp: 50÷300°C, with 1 grid cm.65x53 GN2/1 • **DE** Statischer Elektro-Backofen cm. 67x55x34h, temp: 50÷300°C, mit 1 Rost cm.65x53 GN2/1 • **FR** Four électrique statique cm. 67x55x34h, temp: 50÷300°C, avec 1 grille cm.65x53 GN2/1 • **ES** Horno eléctrico estático cm. 67x55x34h, temp: 50÷300°C, con 1 parilla cm.65x53 GN2/1
cm. 80x 69x 48,6h



⚡ 5 kW **1.765,00**
400V~3N 40 / 0,49
50/60 Hz

FVD-78ET FORNO ELETTRICO VENTILATO CM. 55X36X34H, TEMP: 50÷300°C, CON 1 GRIGLIA CM.53X32,5 GN1/1

26500835

EN Electric fan oven cm. 55x36x34h, temp: 50÷300°C, with 1 grid cm.53x32,5 GN1/1 • **DE** Elektro-Heißluftofen cm. 55x36x34h, temp: 50÷300°C, mit 1 Rost cm.53x32,5 GN1/1 • **FR** Four à chaleur tournante électrique cm. 55x36x34h, temp: 50÷300°C, avec 1 grille cm.53x32,5 GN1/1 • **ES** Horno eléctrico ventilado cm. 55x36x34h, temp: 50÷300°C, con 1 parilla cm.53x32,5 GN1/1
cm. 80x 61,5x 48,6h

⚡ 5,32 kW **2.174,00**
400V~3N 40 / 0,49
230V~3
50/60 Hz

FORNI ELETTRICI 90

MOD. _____
COD. _____

DESCRIZIONE/DESCRIPTION/BEZEICHNUNG/DESCRIPTION/DESCRIPCIÓN
DIMENSIONI/DIMENSIONS/ABMESSUNGEN/DIMENSIONS/DIMENSIONES

POTENZA/POWER/LEISTUNG/PUISSANCE/POTENCIA
VOLTAGGIO/VOLTAGE/SPANNUNG/VOLTAGE/VOLTAJE

⚡ kW _____
kcal/h _____
V~ _____
Hz _____

PREZZO/PRICE
PREIS/PRIX/PRECIO
KG / M³



FSD-98ET
28500830

FORNO ELETTRICO STATICO CM. 67X73X34H, TEMP: 50÷300°C, CON 1 GRIGLIA CM.65X71 GN2/1
EN Traditional electric oven cm. 67x73x34h, temp: 50÷300°C, with 1 grid cm.65x71 GN2/1 • **DE** Statischer Elektro-Backofen cm. 67x73x34h, temp: 50÷300°C, mit 1 Rost cm.65x71 GN2/1 • **FR** Four électrique statique cm. 67x73x34h, temp: 50÷300°C, avec 1 grille cm.65x71 GN2/1 • **ES** Horno eléctrico estático cm. 67x73x34h, temp: 50÷300°C, con 1 parilla cm.65x71 GN2/1
cm. 80x 85,5x 48,6h



⚡ 6,7 kW _____ **1.858,00**
400V~3N _____ 45 / 0,62
50/60 Hz _____

CSD012E
_CSD012E

FORNO PER COTTURA A BASSE TEMPERATURE A 2 CASSETTI GN1/1 MAX CM.15H. TEMP: 30÷120°C. PANNELLO DI CONTROLLO CON REGOLAZIONE ELETTRONICA DEL TEMPO, DELLA TEMPERATURA E DELLA SONDA AL CUORE, FUNZIONE MANTENIMENTO. VERSIONE INCASTRO PER FREEBLOCK 5_0
EN Low temperature oven with 2 drawers GN1/1 max. cm15h, temp: 30÷120°C. Electronic control of the time, temperature and core probe, HOLD function. DROPIN VERSION FOR FREEBLOCK 5_0. • **DE** Niedertemperaturöfen mit 2 SchubladenGN1/1 max. cm.15h, temp: 30÷120°C. Bedienfeld mit elektronischer Einstellung für Zeit, Temperatur, heißer Wartungsfunktion. DROPIN VERSION FÜR FREEBLOCK 5_0. • **FR** Four basse température avec 2 tiroirs GN1/1 max. cm.15h, temp: 30÷120°C. Contrôle électronique du temps, température et sonde à coeur, fonction de maintenance à chaud. DROPIN VERSION POUR FREEBLOCK 5_0. • **ES** Horno de baja temperatura con 2 cajones GN1/1 max. cm.15h, temp: 30÷120°C. Panel de control con regulación electrónica de tiempo, temperatura y sonda al corazón, función de mantenimiento caliente. VERSION DE ENCASTRE PARA FREEBLOCK 5_0.
cm. 80x 61x 51h



⚡ 1 kW _____ **4.070,00**
230V~ _____ 55 / 0,44
50 Hz _____

PCD-44G
24210450

PIANO COTTURA 1 FUOCO
EN Boiling unit - 1 burner • **DE** kochplatte - 1 Kochstellen • **FR** Rechaud - 1 feux vifs • **ES** Sobre de cocción - 1 quemador
cm. 40x 40x 14h



⚡ 10 kW _____ **1.140,00**
8.600 kcal/h _____ 23 / 0,17

PCD-55G
25210550

PIANO COTTURA 1 FUOCO, CON GRIGLIA RIBASSATA PER ALLINEAMENTO AI MODELLI GAS TPD/FTD
EN Boiling unit - 1 burner, with lowered grid for alignment to gas models TPD/FTD • **DE** kochplatte - 1 Kochstellen, mit abgesenktem Gitter zur Ausrichtung mit den Gasmodellen TPD/FTD • **FR** Rechaud - 1 feux vifs, avec grille abaissée pour l'alignement sur les modèles à gaz TPD/FTD • **ES** Sobre de cocción - 1 quemador, con rejilla rebajada para su alineación con los modelos de gas TPD/FTD
cm. 50x 50x 22h



⚡ 10 kW _____ **1.205,00**
8.600 kcal/h _____ 24 / 0,27

PCD-64G
26210450

PIANO COTTURA 2 FUOCHI
EN Gas heated boiling - 2 burners • **DE** Gas-Kochplatte - 2 Kochstellen • **FR** Rechaud gaz - 2 feux vifs • **ES** Sobres de cocción gas - 2 quemadores
cm. 40x 60x 11h



⚡ 13 kW _____ **1.305,00**
11.180 kcal/h _____ 20 / 0,17

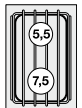

PCD-68G
26210850

PIANO COTTURA 4 FUOCHI
EN Gas heated boiling unit - 4 burners • **DE** Gas-Kochplatte - 4 Kochstellen • **FR** Rechaud gaz - 4 feux vifs • **ES** Sobres de cocción gas - 4 quemadores
cm. 80x 60x 11h



⚡ 22 kW _____ **2.456,00**
18.920 kcal/h _____ 40 / 0,35

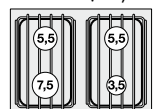

PIANI COTTURA A GAS 80

MOD.
COD.

DESCRIZIONE/DESCRIPTION/BEZEICHNUNG/DESCRIPTION/DESCRIPCIÓN
DIMENSIONI/DIMENSIONS/ABMESSUNGEN/DIMENSIONS/DIMENSIONES

POTENZA/POWER/LEISTUNG/PUISSANCE/POTENCIA
VOLTAGGIO/VOLTAGE/SPANNUNG/VOLTAGE/VOLTAJE

⚡ kW
kcal/h

PREZZO/PRICE
PREIS/PRIX/PRECIO
KG / M³



PCD-84G
28210450

PIANO COTTURA 2 FUOCHI

EN Gas heated boiling - 2 burners • **DE** Gas-Kochplatte - 2 Kochstellen
• **FR** Rechaud gaz - 2 feux vifs • **ES** Sobres de cocción gas - 2 quemadores
cm. 40x 80x 11h



⚡ 11 kW
9.460 kcal/h

1.717,00
55 / 0,23



PCD-88G
28210850

PIANO COTTURA 4 FUOCHI

EN Gas heated boiling unit - 4 burners • **DE** Gas-Kochplatte - 4 Kochstellen • **FR** Rechaud gaz - 4 feux vifs • **ES** Sobres de cocción gas - 4 quemadores
cm. 80x 80x 11h



⚡ 28 kW
24.080 kcal/h

3.007,00
75 / 0,44

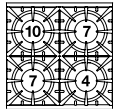

PCAD-84G
28310450

PIANO COTTURA ACQUA 2 FUOCHI - RUBINETTO CARICO ACQUA, SFIORATORE

EN water heated boiling unit 2 burners - Water loading tap + overflow device • **DE** wasser-Kochplatte - 2 Kochstellen - Wasserlauf-Hahn + Überlauf-Vorrichtung • **FR** Rechaud l'eau 2 feux vifs - Robinet d'arrivée d'eau trop plein • **ES** Sobres de cocción agua 2 quemadores - Grifo carga agua + vertedero
cm. 40x 80x 12h



⚡ 14 kW
12.040 kcal/h

2.191,00
55 / 0,23

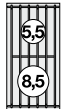

PCAD-88G
28310850

PIANO COTTURA ACQUA 4 FUOCHI - RUBINETTO CARICO ACQUA, SFIORATORE

EN water heated boiling unit 4 burners - Water loading tap + overflow device • **DE** wasser-Kochplatte - 4 Kochstellen - Wasserlauf-Hahn + Überlauf-Vorrichtung • **FR** Rechaud l'eau 4 feux vifs - Robinet d'arrivée d'eau trop plein • **ES** Sobres de cocción agua 4 quemadores - Grifo carga agua + vertedero
cm. 80x 80x 12h



⚡ 28 kW
24.080 kcal/h

3.621,00
75 / 0,44



CPD-74G
27270450

CUOCIPASTA GAS LT 25 VASCA CM. 30,5X33,5X32,7H. RUBINETTO CARICO ACQUA, SFIORATORE + SCARICO A PAVIMENTO. ACCENSIONE ELETTRICA, INDICATORE PRESENZA FIAMMA PILOTA. (CESTI ESCLUSI)

EN Gas pasta cooker 25 lts. Tank cm. 30,5x33,5x32,7h. Water loading cock + overflow device and floor draining. Electric ignition, flame presence indicator. (BASKETS EXCLUDED) • **DE** Gas-Nudelkocher lt. 25. Becken cm. 30,5x33,5x32,7h. Wasserlauf-Hahn, + Überlauf-Vorrichtung und Ablauf am Boden. Elektrische Zündung, Flammenpräsenzanzeige. (KORB AUSGESCHLOSSEN) • **FR** Cuiseur à pâtes gaz lt. 25. Cuve cm.30,5x33,5x32,7h. Robinet d'arrivée d'eau trop plein + système de vidange au sol. Allumage électrique, indicateur de présence de flamme. (PANIERS EXCLUS) • **ES** Cuece pasta gas 25 lt. Cuba cm. 30,5x33,5x32,7h. Grifo carga agua + vertedero + descarga a pavimento. Ignición eléctrica, indicador externo de llama piloto. (CESTAS EXCLUIDAS)
cm. 40x 70x 65h



⚡ 9,5 kW
8.160 kcal/h

2.862,00
51 / 0,37

⚡ 0,02 KW
230V~
50/60 Hz

COMBINAZIONI

• Combinations / • Zusammenstellungen
• Combinaisons / • Combinación múltiple



CUOCIPASTA GAS 70

MOD. _____
COD. _____

DESCRIZIONE/DESCRIPTION/BEZEICHNUNG/DESCRIPTION/DESCRIPCIÓN
DIMENSIONI/DIMENSIONS/ABMESSUNGEN/DIMENSIONS/DIMENSIONES

POTENZA/POWER/LEISTUNG/PUISSANCE/POTENCIA
VOLTAGGIO/VOLTAGE/SPANNUNG/VOLTAGE/VOLTAJE

⚡ kW kcal/h
⚡ kW V~ Hz

PREZZO/PRICE
PREIS/PRIX/PRECIO
KG / M³



CPAD-74G
27270455

CUOCIPASTA GAS LT 25 VASCA CM. 30,5X33,5X32,7H. CARICO ACQUA AUTOMATICO CON SENSORE DI LIVELLO - SFIORATORE + SCARICO A PAVIMENTO. ACCENSIONE ELETTRICA, INDICATORE PRESENZA FIAMMA PILOTA. (CESTI ESCLUSI)

EN Gas pasta cooker 25 lts. Tank cm. 30,5x33,5x32,7h. Automatic Water loading with level sensor - overflow device and floor draining. Electric ignition, flame presence indicator. (BASKETS EXCLUDED) • **DE** Gas-Nudelkocher lt. 25. Becken cm. 30,5x33,5x32,7h. Automatische Wasser Beladung mit Niveauregulierung + Überlauf-Vorrichtung und Ablauf am Boden. Elektrische Zündung, Flammenpräsenzanzeige. (KORB AUSGESCHLOSSEN) • **FR** Cuiseur à pâtes gaz lt. 25. Cuve cm.30,5x33,5x32,7h. Chargement automatique de l'eau avec sensor de niveau, trop plein Système de vidange au sol. Allumage électrique, indicateur de présence de flamme. (PANIERS EXCLUS) • **ES** Cuece pasta gas 25 lt. Cuba cm. 30,5x33,5x32,7h. Carga automática de agua con sensor de nivel + vertedero + descarga a pavimento. Ignición eléctrica, indicador externo de llama piloto. (CESTAS EXCLUIDAS)
cm. 40x 70x 65h



⚡ 9,5 kW kcal/h **3.121,00**
8.160 kcal/h 51 / 0,37

⚡ 0,035 KW
230V~
50/60 Hz

COMBINAZIONI

- Combinations / • Zusammenstellungen
- Combinaisons / • Combinación múltiple

1/1	1/2 1/2	1/4 1/4	1/6 1/6	1/6
		1/4 1/4	1/6 1/6	1/2 1/6
		1/4 1/4	1/6 1/6	1/6

CPD-94G
29270450

CUOCIPASTA GAS LT. 40 VASCA CM. 30,7X50,9X32,7H. RUBINETTO CARICO ACQUA, SFIORATORE + SCARICO A PAVIMENTO. ACCENSIONE ELETTRICA, INDICATORE PRESENZA FIAMMA PILOTA. (CESTI ESCLUSI)

EN Gas pasta cooker 40 lts. - Tank cm. 30,7x50,9x32,7h. Water loading tap + overflow device and floor draining. Electric ignition, flame presence indicator. (BASKETS EXCLUDED) • **DE** Gas-Nudelkocher lt. 40 - Becken cm. 30,7x50,9x32,7h. Wasserlauf-Hahn + Überlauf-Vorrichtung und Ablauf am Boden. Elektrische Zündung, Flammenpräsenzanzeige. (KORB AUSGESCHLOSSEN) • **FR** Cuiseur a pâtes gaz lt. 40 - Cuve cm.30,7x50,9x32,7h. Robinet d'arrivée d'eau trop plein Système de vidange au sol. Allumage électrique, indicateur de présence de flamme. (PANIERS EXCLUS) • **ES** Cuece pasta gas 40 lt. - Cuba cm. 30,7x50,9x32,7h. Grifo carga agua + vertedero + descarga a pavimento. Ignición eléctrica, indicador externo de llama piloto. (CESTAS EXCLUIDAS)
cm. 40x 90x 65h



⚡ 13,95 kW kcal/h **3.060,00**
11.997 kcal/h 58 / 0,46

⚡ 0,02 KW
230V~
50/60 Hz

COMBINAZIONI

- Combinations / • Zusammenstellungen
- Combinaisons / • Combinación múltiple

1/1	1/2	1/3	1/3	1/6 1/6	1/6 1/6
	1/2	1/3	2/3	1/3	1/6 1/6
		1/3		1/3	1/6 1/6

CUOCIPASTA GAS 90

MOD. _____
COD. _____

DESCRIZIONE/DESCRIPTION/BEZEICHNUNG/DESCRIPTION/DESCRIPCIÓN
DIMENSIONI/DIMENSIONS/ABMESSUNGEN/DIMENSIONS/DIMENSIONES

POTENZA/POWER/LEISTUNG/PUISSANCE/POTENCIA
VOLTAGGIO/VOLTAGE/SPANNUNG/VOLTAGE/VOLTAJE

⚡ kW
kcal/h

⚡ kW
V~
Hz

PREZZO/PRICE €
PREIS/PRIX/PRECIO €
KG / M³

CPAD-94G
29270455

CUOCIPASTA GAS LT. 40 VASCA CM. 30,7X50,9X32,7H. CARICO ACQUA AUTOMATICO CON SENSORE DI LIVELLO - SFIORATORE + SCARICO A PAVIMENTO. ACCENSIONE ELETTRICA, INDICATORE PRESENZA FIAMMA PILOTA. (CESTI ESCLUSI)

EN Gas pasta cooker 40 lts. - Tank cm. 30,7x50,9x32,7h. Automatic Water loading with level sensor - overflow device and floor draining. Electric ignition, flame presence indicator. (BASKETS EXCLUDED) • **DE** Gas-Nudelkocher lt. 40 - Becken cm. 30,7x50,9x32,7h. Automatische Wasser Beladung mit Niveauregulierung + Überlauf-Vorrichtung und Ablauf am Boden. Elektrische Zündung, Flammenpräsenzanzeige. (KORB AUSGESCHLOSSEN) • **FR** Cuiseur a pates gaz lt. 40 - Cuve cm.30,7x50,9x32,7h. Chargement automatique de l'eau avec sensor de niveau, trop plein Système de vidange au sol. Allumage électrique, indicateur de présence de flamme. (PANIERS EXCLUS) • **ES** Cuece pasta gas 40 lt. - Cuba cm. 30,7x50,9x32,7h. Carga automática de agua con sensor de nivel + vertedero + descarga a pavimento. Ignición eléctrica, indicador externo de llama piloto. (CESTAS EXCLUIDAS)

cm. 40x 90x 65h



⚡ 13,95 kW
11.997 kcal/h

3.320,00
58 / 0,46

⚡ 0,035 KW
230V~
50/60 Hz

COMBINAZIONI

- Combinations / • Zusammenstellungen
- Combinaisons / • Combinación múltiple

1/1	1/2	1/3	1/3	1/6 1/6	1/6 1/6
	1/2	1/3	2/3	1/3	1/6 1/6
		1/3		1/3	1/6 1/6

CWD-75G
27250550

GRIGLIA GAS-PIETRALAVICA, GRIGLIA IN ACCIAIO INOX CM. 38X52 REGOLABILE. ACCENSIONE ELETTRICA, INDICATORE PRESENZA FIAMMA PILOTA, CANALA PERIMETRALE ALLAGABILE, SCARICO CON FILTRO REMOVIBILE.

EN Charcoal grill gas, Stainless steel grill cm. 38x52. Electric ignition, flame presence indicator, floodable perimeter channel, drain with removable filter. • **DE** Gas-Lavasteingrill, Einstellbarer Rost aus Nirosta cm. 38x52. Elektrische Zündung, Flammenpräsenzanzeige, flutbaren Umfangskanal, Auspuff mit abnehmbarem Filter. • **FR** Grille à gaz en pierre de lave, Grille inox cm 38x52. Allumage électrique, indicateur de présence de flamme, un conduit extérieur inondable, échappement avec filtre amovible. • **ES** Parrilla a gas piedra lávica, Parrilla de acero inox regulable cm 38x52. Ignición eléctrica, indicador externo de llama piloto, canal perimetral inundable, drenaje con filtro extraíble.

cm. 50x 70x 33h



⚡ 9 kW
7.740 kcal/h

2.219,00
51 / 0,26

⚡ 0,01 KW
230V~
50/60 Hz

CWD-79G
27250950

GRIGLIA GAS-PIETRALAVICA, N. 2 GRIGLIE IN ACCIAIO INOX CM. 38X52 REGOLABILI, 2 ZONE DI COTTURA. ACCENSIONE ELETTRICA, INDICATORE PRESENZA FIAMMA PILOTA, CANALA PERIMETRALE ALLAGABILE, SCARICO CON FILTRO REMOVIBILE.

EN Charcoal grill gas, N. 2 Stainless steel grill cm. 38x52. 2 cooking areas. Electric ignition, flame presence indicator, floodable perimeter channel, drain with removable filter. • **DE** Gas-Lavasteingrill, N. 2 einstellbare Roste aus Nirosta cm. 38x52 - 2 Heizzonen. Elektrische Zündung, Flammenpräsenzanzeige, flutbaren Umfangskanal, Auspuff mit abnehmbarem Filter. • **FR** Grille a gaz en pierre de lave, N. 2 grilles réglables en acier inox cm. 38x52. 2 zones de cuisson. Allumage électrique, indicateur de présence de flamme, un conduit extérieur inondable, échappement avec filtre amovible. • **ES** Parrilla a gas piedra lávica, N. 2 Parrillas de acero inox regulable cm 38x52 2 zonas de cocción. Ignición eléctrica, indicador externo de llama piloto, canal perimetral inundable, drenaje con filtro extraíble.

cm. 90x 70x 33h



⚡ 18 kW
15.480 kcal/h

3.276,00
94 / 0,44

⚡ 0,01 KW
230V~
50/60 Hz

TUTTAPIASTRA GAS 70

MOD. _____
COD. _____

DESCRIZIONE/DESCRIPTION/BEZEICHNUNG/DESCRIPTION/DESCRIPCIÓN
DIMENSIONI/DIMENSIONS/ABMESSUNGEN/DIMENSIONS/DIMENSIONES

POTENZA/POWER/LEISTUNG/PUISSANCE/POTENCIA
VOLTAGGIO/VOLTAGE/SPANNUNG/VOLTAGE/VOLTAJE

⚡ kW kcal/h
⚡ kW V~ Hz

PREZZO/PRICE €
PREIS/PRIX/PRECIO €
KG / M³

TPD-85G
28290550

TUTTA PIASTRA GAS PIASTRA CM 37X57. ACCENSIONE ELETTRICA, INDICATORE PRESENZA FIAMMA PILOTA, CANALA PERIMETRALE ALLAGABILE, SCARICO CON FILTRO REMOVIBILE.

EN Solid top gas - Plate.37x57cm. Electric ignition, flame presence indicator, floodable perimeter channel, drain with removable filter.
• **DE** Gas-Kochplatte - Platte.37x57 cm. Elektrische Zündung, Flammenpräsenzanzeige, flutbaren Umfangskanal, Auspuff mit abnehmbarem Filter. • **FR** Toute plaque à gaz - Plaque cm.37x57. Allumage électrique, indicateur de présence de flamme, un conduit extérieur inondable, échappement avec filtre amovible. • **ES** Placa de cocción a gas - Placa cm.37x57. Ignición eléctrica, indicador externo de llama piloto, canal perimetral inundable, drenaje con filtro extraíble.
cm. 50x 80x 31h



⚡ 7 kW kcal/h **3.194,00**
6.020 kcal/h 58 / 0,33

⚡ 0,01 KW
230V~
50/60 Hz

TPD-89G
28290950

TUTTA PIASTRA GAS PIASTRA CM 77X57. ACCENSIONE ELETTRICA, INDICATORE PRESENZA FIAMMA PILOTA, CANALA PERIMETRALE ALLAGABILE, SCARICO CON FILTRO REMOVIBILE.

EN Solid top gas - Plate.77x57cm. Electric ignition, flame presence indicator, floodable perimeter channel, drain with removable filter.
• **DE** Gas-Kochplatte - Platte.77x57 cm. Elektrische Zündung, Flammenpräsenzanzeige, flutbaren Umfangskanal, Auspuff mit abnehmbarem Filter. • **FR** Toute plaque à gaz - Plaque cm.77x57. Allumage électrique, indicateur de présence de flamme, un conduit extérieur inondable, échappement avec filtre amovible. • **ES** Placa de cocción a gas - Placa cm.77x57. Ignición eléctrica, indicador externo de llama piloto, canal perimetral inundable, drenaje con filtro extraíble.
cm. 90x 80x 31h



⚡ 12 kW kcal/h **3.596,00**
10.320 kcal/h 129 / 0,44

⚡ 0,01 KW
230V~
50/60 Hz

TPD-95G
29290550

TUTTA PIASTRA GAS PIASTRA CM 39X73. ACCENSIONE ELETTRICA, INDICATORE PRESENZA FIAMMA PILOTA, CANALA PERIMETRALE ALLAGABILE, SCARICO CON FILTRO REMOVIBILE.

EN Solid top gas - Plate.39x73 cm. Electric ignition, flame presence indicator, floodable perimeter channel, drain with removable filter.
• **DE** Gas-Kochplatte - Platte.39x73 cm. Elektrische Zündung, Flammenpräsenzanzeige, flutbaren Umfangskanal, Auspuff mit abnehmbarem Filter. • **FR** Toute plaque à gaz - Plaque cm.39x73. Allumage électrique, indicateur de présence de flamme, un conduit extérieur inondable, échappement avec filtre amovible. • **ES** Placa de cocción a gas - Placa cm.39x73. Ignición eléctrica, indicador externo de llama piloto, canal perimetral inundable, drenaje con filtro extraíble.
cm. 50x 95x 31h



⚡ 7 kW kcal/h **3.291,00**
6.020 kcal/h 62 / 0,33

⚡ 0,01 KW
230V~
50/60 Hz

TPD-99G
29290950

TUTTA PIASTRA GAS PIASTRA CM 79X73. ACCENSIONE ELETTRICA, INDICATORE PRESENZA FIAMMA PILOTA, CANALA PERIMETRALE ALLAGABILE, SCARICO CON FILTRO REMOVIBILE.

EN Solid top gas - Plate.79x73 cm. Electric ignition, flame presence indicator, floodable perimeter channel, drain with removable filter.
• **DE** Gas-Kochplatte - Platte.79x73 cm. Elektrische Zündung, Flammenpräsenzanzeige, flutbaren Umfangskanal, Auspuff mit abnehmbarem Filter. • **FR** Toute plaque à gaz - Plaque cm.79x73. Allumage électrique, indicateur de présence de flamme, un conduit extérieur inondable, échappement avec filtre amovible. • **ES** Placa de cocción a gas - Placa cm.79x73. Ignición eléctrica, indicador externo de llama piloto, canal perimetral inundable, drenaje con filtro extraíble.
cm. 90x 95x 31h



⚡ 12 kW kcal/h **3.927,00**
10.320 kcal/h 135 / 0,64

⚡ 0,01 KW
230V~
50/60 Hz

MOD. _____
COD. _____

DESCRIZIONE / DESCRIPTION / BEZEICHNUNG / DESCRIPTION / DESCRIPCIÓN
DIMENSIONI / DIMENSIONS / ABMESSUNGEN / DIMENSIONS / DIMENSIONES

POTENZA / POWER / LEISTUNG / PUISSANCE / POTENCIA
VOLTAGGIO / VOLTAGE / SPANNUNG / VOLTAGE / VOLTAJE

⚡ kW _____
kcal/h _____
⚡ kW _____
V~ _____
Hz _____

PREZZO / PRICE
PREIS / PRIX / PRECIO
KG / M³



FTLD-85GS
28230554

FRY-TOP GAS LISCIO CROMATO SUPERCHROME (MOCA APPROVED), PIASTRA CM.39X53,5. ACCENSIONE ELETTRICA, INDICATORE PRESENZA FIAMMA PILOTA, CANALA PERIMETRALE ALLAGABILE, SCARICO CON FILTRO REMOVIBILE.

EN Gas Fry-top smooth chromed griddle SUPERCHROME (Moca Approved), plate cm.39x53,5. Electric ignition, flame presence indicator, floodable perimeter channel, drain with removable filter. • **DE** Gas-griddleplatte glatt hartverchromt SUPERCHROME (Moca Approved), platte cm.39x53,5. Elektrische Zündung, Flammenpräsenzanzeige, flutbaren Umfangskanal, Auspuff mit abnehmbarem Filter. • **FR** Plaque gaz lisse chromée SUPERCHROME (Moca Approved), plaque cm.39x53,5. Allumage électrique, indicateur de présence de flamme, un conduit extérieur inondable, échappement avec filtre amovible. • **ES** Fry-top gas liso cromado SUPERCHROME (Moca Approved), plancha cm.39x53,5. Ignición eléctrica, indicador externo de llama piloto, canal perimetral inundable, drenaje con filtro extraíble.
cm. 50x 80x 33h



⚡ 7 kW _____ **3.914,00**
6.020 kcal/h _____ 53 / 0,33

⚡ 0,01 KW _____
230V~ _____
50/60 Hz _____



FTRD-85GS
28230556

FRY-TOP GAS RIGATO CROMATO SUPERCHROME (MOCA APPROVED), PIASTRA CM.39X53,5. ACCENSIONE ELETTRICA, INDICATORE PRESENZA FIAMMA PILOTA, CANALA PERIMETRALE ALLAGABILE, SCARICO CON FILTRO REMOVIBILE.

EN Gas Fry-top grooved chromed griddle SUPERCHROME (Moca Approved), plate cm.39x53,5. Electric ignition, flame presence indicator, floodable perimeter channel, drain with removable filter. • **DE** Gas-griddleplatte gerillt hartverchromt SUPERCHROME (Moca Approved), platte cm.39x53,5. Elektrische Zündung, Flammenpräsenzanzeige, flutbaren Umfangskanal, Auspuff mit abnehmbarem Filter. • **FR** Plaque gaz nervurée chromée SUPERCHROME (Moca Approved), plaque cm.39x53,5. Allumage électrique, indicateur de présence de flamme, un conduit extérieur inondable, échappement avec filtre amovible. • **ES** Fry-top gas estriado cromado SUPERCHROME (Moca Approved), plancha cm.39x53,5. Ignición eléctrica, indicador externo de llama piloto, canal perimetral inundable, drenaje con filtro extraíble.
cm. 50x 80x 33h



⚡ 7 kW _____ **3.071,00**
6.020 kcal/h _____ 53 / 0,33

⚡ 0,01 KW _____
230V~ _____
50/60 Hz _____



FTLD-87GS
28230754

FRY-TOP GAS LISCIO CROMATO SUPERCHROME (MOCA APPROVED), PIASTRA CM.59X53,5. ACCENSIONE ELETTRICA, INDICATORE PRESENZA FIAMMA PILOTA, CANALA PERIMETRALE ALLAGABILE, SCARICO CON FILTRO REMOVIBILE.

EN Gas Fry-top smooth chromed griddle SUPERCHROME (Moca Approved), plate cm.59x53,5. Electric ignition, flame presence indicator, floodable perimeter channel, drain with removable filter. • **DE** Gas-griddleplatte glatt hartverchromt SUPERCHROME (Moca Approved), platte cm.59x53,5. Elektrische Zündung, Flammenpräsenzanzeige, flutbaren Umfangskanal, Auspuff mit abnehmbarem Filter. • **FR** Plaque gaz lisse chromée SUPERCHROME (Moca Approved), plaque cm.59x53,5. Allumage électrique, indicateur de présence de flamme, un conduit extérieur inondable, échappement avec filtre amovible. • **ES** Fry-top gas liso cromado SUPERCHROME (Moca Approved), plancha cm.59x53,5. Ignición eléctrica, indicador externo de llama piloto, canal perimetral inundable, drenaje con filtro extraíble.
cm. 70x 80x 33h



⚡ 10,5 kW _____ **3.063,00**
9.030 kcal/h _____ 62 / 0,35

⚡ 0,01 KW _____
230V~ _____
50/60 Hz _____



FRY-TOP A GAS 80

MOD. _____
COD. _____

DESCRIZIONE/DESCRIPTION/BEZEICHNUNG/DESCRIPTION/DESCRIPCIÓN
DIMENSIONI/DIMENSIONS/ABMESSUNGEN/DIMENSIONS/DIMENSIONES

POTENZA/POWER/LEISTUNG/PUISSANCE/POTENCIA
VOLTAGGIO/VOLTAGE/SPANNUNG/VOLTAGE/VOLTAJE

⚡ kW
kcal/h

⚡ kW
V~
Hz

PREZZO/PRICE
PREIS/PRIX/PRECIO
KG / M³



FTLRD-87GS FRY-TOP GAS 1/2 RIGATO + 1/2 LISCIO CROMATO SUPERCHROME (MOCA APPROVED), PIASTRA CM.59X53,5. ACCENSIONE ELETTRICA, INDICATORE PRESENZA FIAMMA PILOTA, CANALA PERIMETRALE ALLAGABILE, SCARICO CON FILTRO REMOVIBILE.

28230755

EN Gas Fry-top 1/2 grooved + 1/2 smooth chromed griddle SUPERCHROME (Moca Approved), plate cm.59x53,5. Electric ignition, flame presence indicator, floodable perimeter channel, drain with removable filter. • **DE** Gas-griddleplatte 1/2 gerillt + 1/2 glatt hartverchromt SUPERCHROME (Moca Approved), platte cm.59x53,5. Elektrische Zündung, Flammenpräsenzanzeige, flutbaren Umfangskanal, Auspuff mit abnehmbarem Filter. • **FR** Plaque gaz 1/2 nervurée + 1/2 lisse chromée SUPERCHROME (Moca Approved), plaque cm.59x53,5. Allumage électrique, indicateur de présence de flamme, un conduit extérieur inondable, échappement avec filtre amovible. • **ES** Fry-top gas 1/2 estriado + 1/2 liso cromado SUPERCHROME (Moca Approved), plancha cm.59x53,5. Ignición eléctrica, indicador externo de llama piloto, canal perimetral inundable, drenaje con filtro extraíble.

cm. 70x 80x 33h



⚡ 10,5 kW
9.030 kcal/h

3.196,00
62 / 0,35

⚡ 0,01 KW
230V~
50/60 Hz



FTRD-87GS FRY-TOP GAS RIGATO CROMATO SUPERCHROME (MOCA APPROVED), PIASTRA CM.59X53,5. ACCENSIONE ELETTRICA, INDICATORE PRESENZA FIAMMA PILOTA, CANALA PERIMETRALE ALLAGABILE, SCARICO CON FILTRO REMOVIBILE.

28230756

EN Gas Fry-top grooved chromed griddle SUPERCHROME (Moca Approved), plate cm.59x53,5. Electric ignition, flame presence indicator, floodable perimeter channel, drain with removable filter. • **DE** Gas-griddleplatte gerillt hartverchromt SUPERCHROME (Moca Approved), platte cm.59x53,5. Elektrische Zündung, Flammenpräsenzanzeige, flutbaren Umfangskanal, Auspuff mit abnehmbarem Filter. • **FR** Plaque gaz nervurée chromée SUPERCHROME (Moca Approved), plaque cm.59x53,5. Allumage électrique, indicateur de présence de flamme, un conduit extérieur inondable, échappement avec filtre amovible. • **ES** Fry-top gas estriado cromado SUPERCHROME (Moca Approved), plancha cm.59x53,5. Ignición eléctrica, indicador externo de llama piloto, canal perimetral inundable, drenaje con filtro extraíble.

cm. 70x 80x 33h



⚡ 10,5 kW
9.030 kcal/h

3.298,00
62 / 0,35

⚡ 0,01 KW
230V~
50/60 Hz



FTLD-89GS FRY-TOP GAS LISCIO CROMATO SUPERCHROME (MOCA APPROVED), PIASTRA CM.79X53,5 - 2 ZONE DI COTTURA. ACCENSIONE ELETTRICA, INDICATORE PRESENZA FIAMMA PILOTA, CANALA PERIMETRALE ALLAGABILE, SCARICO CON FILTRO REMOVIBILE.

28230954

EN Gas Fry-top smooth chromed griddle SUPERCHROME (Moca Approved), plate cm.79x53,5 - 2 cooking areas. Electric ignition, flame presence indicator, floodable perimeter channel, drain with removable filter. • **DE** Gas-griddleplatte glatt hartverchromt SUPERCHROME (Moca Approved), platte cm.79x53,5 - 2 Heizzonen. Elektrische Zündung, Flammenpräsenzanzeige, flutbaren Umfangskanal, Auspuff mit abnehmbarem Filter. • **FR** Plaque gaz lisse chromée SUPERCHROME (Moca Approved), plaque cm.79x53,5 - 2 zones de cuisson. Allumage électrique, indicateur de présence de flamme, un conduit extérieur inondable, échappement avec filtre amovible. • **ES** Fry-top gas liso cromado SUPERCHROME (Moca Approved), plancha cm.79x53,5 - 2 zonas de cocción. Ignición eléctrica, indicador externo de llama piloto, canal perimetral inundable, drenaje con filtro extraíble.

cm. 90x 80x 33h



⚡ 14 kW
12.040 kcal/h

3.906,00
98 / 0,44

⚡ 0,01 KW
230V~
50/60 Hz

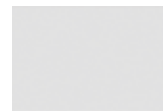

MOD. _____
COD. _____

DESCRIZIONE/DESCRIPTION/BEZEICHNUNG/DESCRIPTION/DESCRIPCIÓN
DIMENSIONI/DIMENSIONS/ABMESSUNGEN/DIMENSIONS/DIMENSIONES

POTENZA/POWER/LEISTUNG/PUISSANCE/POTENCIA
VOLTAGGIO/VOLTAGE/SPANNUNG/VOLTAGE/VOLTAJE

⚡ kW
kcal/h

⚡ kW
V~
Hz

PREZZO/PRICE
PREIS/PRIX/PRECIO
KG / M³



FTLRD-89GS FRY-TOP GAS 1/2 RIGATO + 1/2 LISCIO CROMATO SUPERCHROME (MOCA APPROVED), PIASTRA CM.79X53,5 - 2 ZONE DI COTTURA. ACCENSIONE ELETTRICA, INDICATORE PRESENZA FIAMMA PILOTA, CANALA PERIMETRALE ALLAGABILE, SCARICO CON FILTRO REMOVIBILE.

28230955

EN Gas Fry-top 1/2 grooved + 1/2 smooth chromed griddle SUPERCHROME (Moca Approved), plate cm.79x53,5 - 2 cooking areas. Electric ignition, flame presence indicator, floodable perimeter channel, drain with removable filter. • **DE** Gas-griddleplatte 1/2 gerillt + 1/2 glatt hartverchromt SUPERCHROME (Moca Approved), platte cm.79x53,5 - 2 Heizzonen. Elektrische Zündung, Flammenpräsenzanzeige, flutbaren Umfangskanal, Auspuff mit abnehmbarem Filter. • **FR** Plaque gaz 1/2 nervurée + 1/2 lisse chromée SUPERCHROME (Moca Approved), plaque cm.79x53,5 - 2 zones de cuisson. Allumage électrique, indicateur de présence de flamme, un conduit extérieur inondable, échappement avec filtre amovible. • **ES** Fry-top gas 1/2 estriado + 1/2 liso cromado SUPERCHROME (Moca Approved), plancha cm.79x53,5 - 2 zonas de cocción. Ignición eléctrica, indicador externo de llama piloto, canal perimetral inundable, drenaje con filtro extraíble.
cm. 90x 80x 33h



⚡ 14 kW
12.040 kcal/h

4.084,00
98 / 0,44

⚡ 0,01 KW
230V~
50/60 Hz



FTLRD-89GS FRY-TOP GAS RIGATO CROMATO SUPERCHROME (MOCA APPROVED), PIASTRA CM.79X53,5 - 2 ZONE DI COTTURA. ACCENSIONE ELETTRICA, INDICATORE PRESENZA FIAMMA PILOTA, CANALA PERIMETRALE ALLAGABILE, SCARICO CON FILTRO REMOVIBILE.

28230956

EN Gas Fry-top grooved chromed griddle SUPERCHROME (Moca Approved), plate cm.79x53,5 - 2 cooking areas. Electric ignition, flame presence indicator, floodable perimeter channel, drain with removable filter. • **DE** Gas-griddleplatte gerillt hartverchromt SUPERCHROME (Moca Approved), platte cm.79x53,5 - 2 Heizzonen. Elektrische Zündung, Flammenpräsenzanzeige, flutbaren Umfangskanal, Auspuff mit abnehmbarem Filter. • **FR** Plaque gaz nervurée chromée SUPERCHROME (Moca Approved), plaque cm.79x53,5 - 2 zones de cuisson. Allumage électrique, indicateur de présence de flamme, un conduit extérieur inondable, échappement avec filtre amovible. • **ES** Fry-top gas estriado cromado SUPERCHROME (Moca Approved), plancha cm.79x53,5 - 2 zonas de cocción. Ignición eléctrica, indicador externo de llama piloto, canal perimetral inundable, drenaje con filtro extraíble.
cm. 90x 80x 33h



⚡ 14 kW
12.040 kcal/h

4.272,00
98 / 0,44

⚡ 0,01 KW
230V~
50/60 Hz



FTLRD-95GS FRY-TOP GAS LISCIO CROMATO SUPERCHROME (MOCA APPROVED), PIASTRA CM.39X68,5. ACCENSIONE ELETTRICA, INDICATORE PRESENZA FIAMMA PILOTA, CANALA PERIMETRALE ALLAGABILE, SCARICO CON FILTRO REMOVIBILE.

29230554

EN Gas Fry-top smooth chromed griddle SUPERCHROME (Moca Approved), plate cm.39x68,5. Electric ignition, flame presence indicator, floodable perimeter channel, drain with removable filter. • **DE** Gas-griddleplatte glatt hartverchromt SUPERCHROME (Moca Approved), platte cm.39x68,5. Elektrische Zündung, Flammenpräsenzanzeige, flutbaren Umfangskanal, Auspuff mit abnehmbarem Filter. • **FR** Plaque gaz lisse chromée SUPERCHROME (Moca Approved), plaque cm.39x68,5. Allumage électrique, indicateur de présence de flamme, un conduit extérieur inondable, échappement avec filtre amovible. • **ES** Fry-top gas liso cromado SUPERCHROME (Moca Approved), plancha cm.39x68,5. Ignición eléctrica, indicador externo de llama piloto, canal perimetral inundable, drenaje con filtro extraíble.
cm. 50x 95x 33h



⚡ 9 kW
7.7440 kcal/h

3.355,00
61 / 0,33

⚡ 0,01 KW
230V~
50/60 Hz



FRY-TOP A GAS 90

MOD. _____
COD. _____

DESCRIZIONE/DESCRIPTION/BEZEICHNUNG/DESCRIPTION/DESCRIPCIÓN
DIMENSIONI/DIMENSIONS/ABMESSUNGEN/DIMENSIONS/DIMENSIONES

POTENZA/POWER/LEISTUNG/PUISSANCE/POTENCIA
VOLTAGGIO/VOLTAGE/SPANNUNG/VOLTAGE/VOLTAJE

⚡ kW _____
kcal/h _____
⚡ kW _____
V~ _____
Hz _____

PREZZO/PRICE
PREIS/PRIX/PRECIO
KG / M³



FTRD-95GS
29230556

FRY-TOP GAS RIGATO CROMATO SUPERCHROME (MOCA APPROVED), PIASTRA CM.39X68,5. ACCENSIONE ELETTRICA, INDICATORE PRESENZA FIAMMA PILOTA, CANALA PERIMETRALE ALLAGABILE, SCARICO CON FILTRO REMOVIBILE.

EN Gas Fry-top grooved chromed griddle SUPERCHROME (Moca Approved), plate cm.39x68,5. Electric ignition, flame presence indicator, floodable perimeter channel, drain with removable filter. • **DE** Gas-griddleplatte gerillt hartverchromt SUPERCHROME (Moca Approved), platte cm.39x68,5. Elektrische Zündung, Flammenpräsenzanzeige, flutbaren Umfangskanal, Auspuff mit abnehmbarem Filter. • **FR** Plaque gaz nervurée chromée SUPERCHROME (Moca Approved), plaque cm.39x68,5. Allumage électrique, indicateur de présence de flamme, un conduit extérieur inondable, échappement avec filtre amovible. • **ES** Fry-top gas estriado cromado SUPERCHROME (Moca Approved), plancha cm.39x68,5. Ignición eléctrica, indicador externo de llama piloto, canal perimetral inundable, drenaje con filtro extraíble.
cm. 50x 95x 33h



⚡ 9 kW _____ **3.532,00**
7.7440 kcal/h _____ 61 / 0,33

⚡ 0,01 KW _____
230V~ _____
50/60 Hz _____



FTLD-99GS
29230954

FRY-TOP GAS LISCIO CROMATO SUPERCHROME (MOCA APPROVED), PIASTRA CM.79X68,5 - 2 ZONE DI COTTURA. ACCENSIONE ELETTRICA, INDICATORE PRESENZA FIAMMA PILOTA, CANALA PERIMETRALE ALLAGABILE, SCARICO CON FILTRO REMOVIBILE.

EN Gas Fry-top smooth chromed griddle SUPERCHROME (Moca Approved), plate cm.79x68,5 - 2 cooking areas. Electric ignition, flame presence indicator, floodable perimeter channel, drain with removable filter. • **DE** Gas-griddleplatte glatt hartverchromt SUPERCHROME (Moca Approved), platte cm.79x68,5 - 2 Heizzonen. Elektrische Zündung, Flammenpräsenzanzeige, flutbaren Umfangskanal, Auspuff mit abnehmbarem Filter. • **FR** Plaque gaz lisse chromée SUPERCHROME (Moca Approved), plaque cm.79x68,5 - 2 zones de cuisson. Allumage électrique, indicateur de présence de flamme, un conduit extérieur inondable, échappement avec filtre amovible. • **ES** Fry-top gas liso cromado SUPERCHROME (Moca Approved), plancha cm.79x68,5 - 2 zonas de cocción. Ignición eléctrica, indicador externo de llama piloto, canal perimetral inundable, drenaje con filtro extraíble.
cm. 90x 95x 33h



⚡ 18 kW _____ **4.767,00**
15.480 kcal/h _____ 102 / 0,64

⚡ 0,01 KW _____
230V~ _____
50/60 Hz _____

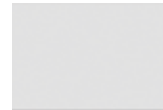

FTLRD-99GS
29230955

FRY-TOP GAS 1/2 RIGATO + 1/2 LISCIO CROMATO SUPERCHROME (MOCA APPROVED), PIASTRA CM.79X68,5 - 2 ZONE DI COTTURA. ACCENSIONE ELETTRICA, INDICATORE PRESENZA FIAMMA PILOTA, CANALA PERIMETRALE ALLAGABILE, SCARICO CON FILTRO REMOVIBILE.

EN Gas Fry-top 1/2 grooved + 1/2 smooth chromed griddle SUPERCHROME (Moca Approved), plate cm.79x68,5 - 2 cooking areas. Electric ignition, flame presence indicator, floodable perimeter channel, drain with removable filter. • **DE** Gas-griddleplatte 1/2 gerillt + 1/2 glatt hartverchromt SUPERCHROME (Moca Approved), platte cm.79x68,5 - 2 Heizzonen. Elektrische Zündung, Flammenpräsenzanzeige, flutbaren Umfangskanal, Auspuff mit abnehmbarem Filter. • **FR** Plaque gaz 1/2 nervurée + 1/2 lisse chromée SUPERCHROME (Moca Approved), plaque cm.79x68,5 - 2 zones de cuisson. Allumage électrique, indicateur de présence de flamme, un conduit extérieur inondable, échappement avec filtre amovible. • **ES** Fry-top gas 1/2 estriado + 1/2 liso cromado SUPERCHROME (Moca Approved), plancha cm.79x68,5 - 2 zonas de cocción. Ignición eléctrica, indicador externo de llama piloto, canal perimetral inundable, drenaje con filtro extraíble.
cm. 90x 95x 33h



⚡ 18 kW _____ **4.987,00**
15.480 kcal/h _____ 102 / 0,64

⚡ 0,01 KW _____
230V~ _____
50/60 Hz _____



FRY-TOP A GAS 90

MOD. _____
COD. _____

DESCRIZIONE/DESCRIPTION/BEZEICHNUNG/DESCRIPTION/DESCRIPCIÓN
DIMENSIONI/DIMENSIONS/ABMESSUNGEN/DIMENSIONS/DIMENSIONES

POTENZA/POWER/LEISTUNG/PUISSANCE/POTENCIA
VOLTAGGIO/VOLTAGE/SPANNUNG/VOLTAGE/VOLTAJE

⚡ kW kcal/h
⚡ kw V~ Hz

PREZZO/PRICE
PREIS/PRIX/PRECIO
KG / M³



FREEBLOCK
FREELOTUS

FTRD-99GS
29230956

FRY-TOP GAS RIGATO CROMATO SUPERCHROME (MOCA APPROVED), PIASTRA CM.79X68,5 - 2 ZONE DI COTTURA. ACCENSIONE ELETTRICA, INDICATORE PRESENZA FIAMMA PILOTA, CANALA PERIMETRALE ALLAGABILE, SCARICO CON FILTRO REMOVIBILE.

EN Gas Fry-top grooved chromed griddle SUPERCHROME (Moca Approved), plate cm.79x68,5 - 2 cooking areas. Electric ignition, flame presence indicator, floodable perimeter channel, drain with removable filter. • **DE** Gas-griddleplatte gerillt hartverchromt SUPERCHROME (Moca Approved), platte cm.79x68,5 - 2 Heizzonen. Elektrische Zündung, Flammenpräsenzanzeige, flutbaren Umfangskanal, Auspuff mit abnehmbarem Filter. • **FR** Plaque gaz nervurée chromée SUPERCHROME (Moca Approved), plaque cm.79x68,5 - 2 zones de cuisson. Allumage électrique, indicateur de présence de flamme, un conduit extérieur inondable, échappement avec filtre amovible. • **ES** Fry-top gas estriado cromado SUPERCHROME (Moca Approved), plancha cm.79x68,5 - 2 zonas de cocción. Ignición eléctrica, indicador externo de llama piloto, canal perimetral inundable, drenaje con filtro extraíble.
cm. 90x 95x 33h



⚡ 18 kW 5.206,00
15.480 kcal/h 102 / 0,64

⚡ 0,01 KW
230V~
50/60 Hz



LAD-64
26020400

LAVELLO RUBINETTO A LEVA - VASCA CM.29X35X20H

EN Sink unit - Lever type tap. Bowl cm.29x35x20h • **DE** Spülbecken Einhebel-Mischbatterie - Becken cm.29x35x20h • **FR** Bac-évier avec robinetterie - Bac cm.29x35x20h • **ES** Fregadero - Grifo a palanca - Pileta cm.29x35x20h
cm. 40x 60x 35h



922,00
18 / 0,13

OPT-GA

ACCENSIONE ELETTRICA PER APPARECCHI GAS: PCD-64GA, PCD-68GA (PREZZO A BRUCIATORE)

EN electric ignition for gas model: PCD-64GA, PCD-68GA (PRICE FOR 1 BURNER) • **DE** elektrische Zündung für gas modell: PCD-64GA, PCD-68GA (PREIS FÜR 1 BRENNER) • **FR** allumage électrique pour modèle a gaz: PCD-64GA, PCD-68GA (PRIX POUR 1 BRÛLEUR) • **ES** ignición eléctrica para modelo gas: PCD-64GA, PCD-68GA (PRECIO POR 1 QUEMADOR)



⚡ 0,01 KW 250,00
230V~ /
50/60 Hz

532005901 GRIGLIA 1 FUOCO

EN 1 flame grill • **DE** Rost 1 flamme • **FR** Frille 1 feu • **ES** Parilla 1 quemador

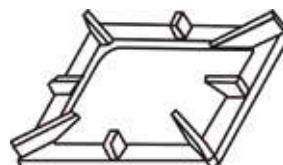

107,00
3 / 0,01

PLF
07590401

PIASTRA LISCIA PER GRIGLIA IN GHISA

EN Smooth griddle plate for cast iron grid • **DE** Fortkochplatte glatt für Gusseisen Rost • **FR** Plaque lisse pour la grille en fonte • **ES** Plancha lisa para rejilla de hierro fundido
cm. 35x 27



190,00
9 / 0,01

PLF/2
07590421

PIASTRA LISCIA 2 FUOCHI PER GRIGLIA IN GHISA

EN Smooth griddle plate 2 burners for cast iron grid • **DE** Fortkochplatte glatt 2 Kochstellen für Gusseisen Rost • **FR** Plaque lisse 2 feux pour la grille en fonte • **ES** Plancha lisa 2 quemadores para rejilla de hierro fundido
cm. 35x 57



375,00
18 / 0,01

PRF
07590403

PIASTRA RIGATA PER GRIGLIA IN GHISA

EN Grooved griddle plate for cast iron grid • **DE** Fortkochplatte gerillt für Gusseisen Rost • **FR** Plaque nervurée pour la grille en fonte • **ES** Plancha estriada para rejilla de hierro fundido
cm. 35x 27

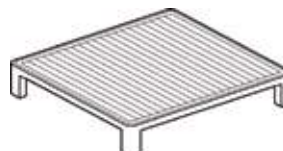

254,00
9 / 0,01

ACCESSORI

MOD. _____
COD. _____

DESCRIZIONE/DESCRIPTION/BEZEICHNUNG/DESCRIPTION/DESCRIPCIÓN
DIMENSIONI/DIMENSIONS/ABMESSUNGEN/DIMENSIONS/DIMENSIONES

POTENZA/POWER/LEISTUNG/PUISSANCE/POTENCIA
VOLTAGGIO/VOLTAGE/SPANNUNG/VOLTAGE/VOLTAJE

⚡ kcal/h ⚡ kw
V~ Hz

PREZZO/PRICE
PREIS/PRIX/PRECIO
KG / M³



PRF/2
07590423

PIASTRA RIGATA 2 FUOCHI PER GRIGLIA IN GHISA
EN Grooved griddle plate 2 burners for cast iron grid • **DE** Fortkochplatte gerillt 2 Kochstellen für Gusseisen Rost • **FR** Plaque nervurée 2 feux pour la grille en fonte • **ES** Plancha estriada 2 quemadores para rejilla de hierro fundido
cm. 35x 57



417,00
18 / 0,01

PLFT/7
08590451

PIASTRA LISCIA PER GRIGLIA IN TONDINO
EN Smooth griddle plate for grid rod • **DE** Fortkochplatte glatt für Gitterstab • **FR** Plaque lisse pour tige grille • **ES** Plancha lisa por red de varilla
cm. 35x 27



190,00
9 / 0,01

PLFT/72
08590471

PIASTRA LISCIA 2 FUOCHI PER GRIGLIA IN TONDINO
EN Smooth griddle plate 2 burners for grid rod • **DE** Fortkochplatte glatt 2 Kochstellen für Gitterstab • **FR** Plaque lisse 2 feux pour tige grille • **ES** Plancha lisa 2 quemadores por red de varilla
cm. 35x 57



375,00
18 / 0,01

PRFT/7
08590453

PIASTRA RIGATA PER GRIGLIA IN TONDINO
EN Grooved griddle plate for grid rod • **DE** Fortkochplatte gerillt für Gitterstab • **FR** Plaque nervurée pour tige grille • **ES** Plancha estriada por red de varilla
cm. 35x 27

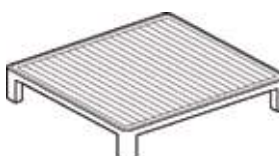

254,00
9 / 0,01

PRFT/72
08590473

PIASTRA RIGATA 2 FUOCHI PER GRIGLIA IN TONDINO
EN Grooved griddle plate 2 burners for grid rod • **DE** Fortkochplatte gerillt 2 Kochstellen für Gitterstab • **FR** Plaque nervurée 2 feux pour tige grille • **ES** Plancha estriada 2 quemadores por red de varilla
cm. 35x 57



417,00
18 / 0,01

KIT-WOK
09580040

KIT WOK - FIAMMA VERTICALE - SOLO SU BRUCIATORE DA 10 KW E GRIGLIE IN GHISA
EN KIT WOK - vertical flame - only for 10 kW burner and cast iron grills • **DE** KIT WOK - vertikaler Flamme - nur 10 kW-Brenner und Roste aus Gusseisen • **FR** KIT WOK - verticale de la flamme - seulement 10 kW brûleur et grilles en fonte • **ES** KIT WOK - llama vertical - sólo 10 kW quemador y parrilas de hierro colado
cm. Ø 26x 16h



422,00
5 / 0,02

533009200

GRIGLIA DI RIDUZIONE
EN Reduction • **DE** Reduzierstern • **FR** Grille de réduction • **ES** Rejilla de reducción
cm. 25x 25

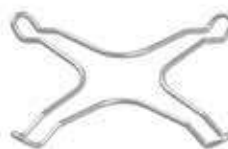

40,00
0.2 / 0,00

531070200

CESTO 1/1 PER CPD-64 - 2/3 PER CPD-84
EN Basket 1/1 for CPD-64 - 2/3 for CPD-84 • **DE** Korb 1/1 für CPD-64 - 2/3 für CPD-84 • **FR** Panier 1/1 pour CPD-64 - 2/3 pour CPD-84 • **ES** Cesta 1/1 para CPD-64 - 2/3 para CPD-84
cm. 28x 32x 21,5h



171,00
2 / 0,00

ACCESSORI CUOCIPASTA

MOD. _____
COD. _____

DESCRIZIONE/DESCRIPTION/BEZEICHNUNG/DESCRIPTION/DESCRIPCIÓN
DIMENSIONI/DIMENSIONS/ABMESSUNGEN/DIMENSIONS/DIMENSIONES

POTENZA/POWER/LEISTUNG/PUISSANCE/POTENCIA
VOLTAGGIO/VOLTAGE/SPANNUNG/VOLTAGE/VOLTAJE

⚡ kW kcal/h
⚡ kw V~ Hz

PREZZO/PRICE
PREIS/PRIX/PRECIO
KG / M³



FREEBLOCK
FREELOTUS

531032400 CESTO 1/2 PER CPD-64

EN Basket 1/2 for CPD-64 • **DE** Korb 1/2 für CPD-64 • **FR** Panier 1/2 pour CPD-64 • **ES** Cesta 1/2 para CPD-64
cm. 14x 32x 20h

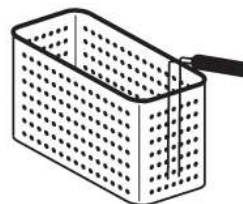

..324..

118,00
1.5 / 0,05

531047900 CESTO 1/2 PER CPD-64 - 1/3 PER CPD-84

EN Basket 1/2 for CPD-64 - 1/3 for CPD-84 • **DE** Korb 1/2 für CPD-64 - 1/3 für CPD-84 • **FR** Panier 1/2 pour CPD-64 - 1/3 pour CPD-84
• **ES** Cesta 1/2 para CPD-64 - 1/3 para CPD-84
cm. 28x 16x 21,5h



123,00
1.5 / 0,04

531048000 CESTO 1/4 PER CPD-64 - 1/6 PER CPD-84

EN Basket 1/4 for CPD-64 - 1/6 for CPD-84 • **DE** Korb 1/4 für CPD-64 - 1/6 für CPD-84 • **FR** Panier 1/4 pour CPD-64 - 1/6 pour CPD-84
• **ES** Cesta 1/4 para CPD-64 - 1/6 para CPD-84
cm. 13,5x 16x 21,5h



94,00
1 / 0,02

531032600 CESTO 1/6 PER CPD-64

EN Basket 1/6 for CPD-64 • **DE** Korb 1/6 für CPD-64 • **FR** Panier 1/6 pour CPD-64 • **ES** Cesta 1/6 para CPD-64
cm. 14x 10x 20h

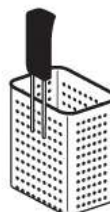

..326..

83,00
0.7 / 0,02

531070300 CESTO 1/1 PER CPD-84

EN Basket 1/1 for CPD-84 • **DE** Korb 1/1 für CPD-84 • **FR** Panier 1/1 pour CPD-84 • **ES** Cesta 1/1 para CPD-84
cm. 28x 49x 21,5h



248,00
3,5 / 0,08

531070100 CESTO 1/2 PER CPD-84

EN Basket 1/2 for CPD-84 • **DE** Korb 1/2 für CPD-84 • **FR** Panier 1/2 pour CPD-84 • **ES** Cesta 1/2 para CPD-84
cm. 28x 24x 21,5h



155,00
1 / 0,05

ACCESSORI CUOCIPASTA

MOD. _____
COD. _____

DESCRIZIONE/DESCRIPTION/BEZEICHNUNG/DESCRIPTION/DESCRIPCIÓN
DIMENSIONI/DIMENSIONS/ABMESSUNGEN/DIMENSIONS/DIMENSIONES

POTENZA/POWER/LEISTUNG/PUISSANCE/POTENCIA
VOLTAGGIO/VOLTAGE/SPANNUNG/VOLTAGE/VOLTAJE

⚡ kW kcal/h
⚡ kw V~ Hz

PREZZO/PRICE
PREIS/PRIX/PRECIO
KG / M³



531071100 CESTO CON GANCIO 1/2 PER CPD-64

EN Basket with hook 1/2 for CPD-64 • **DE** Korb mit Haken 1/2 für CPD-64 • **FR** Panier avec crochet 1/2 pour CPD-64 • **ES** Cesta con gancho 1/2 para CPD-64
cm. 14,5x 29x 20h



166,00
1.5 / 0,05

531069300 GRIGLIA SUPPORTO CESTI CON GANCIO PER CPD-64

EN support for baskets with hook for CPD-64 • **DE** Unterstützung für Körbe mit Haken für CPD-64 • **FR** soutien pour les paniers avec crochet pour CPD-64 • **ES** soporte para cestas con gancho para CPD-64
cm. 30x 33x 41h



141,00
3.5 / 0,06

08550400 COPERCHIO BRFD-64

EN Lid BRFD-64 • **DE** Deckel BRFD-64 • **FR** Couvercle BRFD-64 • **ES** Tapa BRFD-64
cm. 32x 53x 5h



143,00
2 / 0,02

531013200 CESTO 1/2 PER F10D-E

EN Basket 1/2 for F10D-E • **DE** Korb 1/2 for F10D-E • **FR** Panier 1/2 for F10D-E • **ES** Cesta 1/2 for F10D-E
cm. 10x 30x 12h



58,00
0.7 / 0,03

531041600 CESTINO 1/2 PER F18D-64E

EN Basket 1/2 for F18D-64E • **DE** Korb 1/2 zur Friteuse F18D-64E • **FR** Panier 1/2 pour F18D-64E • **ES** Cesta 1/2 para F18D-64E
cm. 13,5x 29x 15h



78,00
0.8 / 0,04



STRUTTURE SBALZO 1 LATO S90

MOD. _____
COD. _____

DESCRIZIONE/DESCRIPTION/BEZEICHNUNG/DESCRIPTION/DESCRIPCIÓN
DIMENSIONI/DIMENSIONS/ABMESSUNGEN/DIMENSIONS/DIMENSIONES

POTENZA/POWER/LEISTUNG/PUISSANCE/POTENCIA
VOLTAGGIO/VOLTAGE/SPANNUNG/VOLTAGE/VOLTAJE

$\frac{kW}{kcal/h}$ $\frac{V}{Hz}$

PREZZO/PRICE
PREIS/PRIX/PRECIO
KG / M³

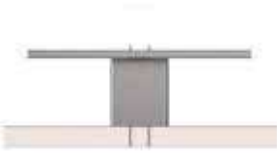

SB90T-2,0 01509200	STRUTTURA SBALZO 1 LATO SERIE 90T, 1 PIEDE PER FISSAGGIO A TERRA EN CANTILEVER STRUCTURE 1 side S90T, 1 foot for ground fixing • DE BRÜCKENSTRUKTURE 1 seite S90T, 1 steher für bodenverankerung • FR STRUCTURE SUSPENDUES 1 coté S90T, 1 pied pour le fixage au sol • ES ESTRUCTURA SUSPENDIDA 1 lado S90T, 1 pata para fijacion al suelo cm. 200x113,1x 90h		4.248,00 113 / 1,62
SB90T-2,4 01509240	cm. 240x113,1x 90h		4.560,00 123 / 1,93
SB90T-2,8 01509280	STRUTTURA SBALZO 1 LATO SERIE 90T, 2 PIEDI PER FISSAGGIO A TERRA EN CANTILEVER STRUCTURE 1 side S90T, 2 feet for ground fixing • DE BRÜCKENSTRUKTURE 1 seite S90T, 2 stehern für bodenverankerung • FR STRUCTURE SUSPENDUES 1 coté S90T, 2 pieds pour le fixage au sol • ES ESTRUCTURA SUSPENDIDA 1 lado S90T, 2 patas para fijacion al suelo cm. 280x113,1x 90h		6.456,00 194 / 2,23
SB90T-3,2 01509320	cm. 320x113,1x 90h		6.768,00 221 / 2,54
SB90T-3,6 01509360	cm. 360x113,1x 90h		7.080,00 242 / 2,85
SB90T-4,0 01509400	cm. 400x113,1x 90h		7.393,00 263 / 3,16
SB90T-4,4 01509440	cm. 440x113,1x 90h		7.705,00 290 / 3,47
SB90T-4,8 01509480	cm. 480x113,1x 90h		8.017,00 311 / 3,77
SB90T-5,2 01509520	cm. 520x113,1x 90h		8.331,00 338 / 4,08
SB90T-5,6 01509560	cm. 560x113,1x 90h		8.643,00 359 / 4,39
SB90T-6,0 01509600	cm. 600x113,1x 90h		8.956,00 380 / 4,70

SB99T-2,0 01599200	STRUTTURA SBALZO 2 LATI SERIE 90T, 1 PIEDE PER FISSAGGIO A TERRA EN CANTILEVER STRUCTURE 2 sides S90T, 1 foot for ground fixing • DE BRÜCKENSTRUKTURE 2 seiten S90T, 1 steher für bodenverankerung • FR STRUCTURE SUSPENDUES 2 cotés S90T, 1 pied pour le fixage au sol • ES ESTRUCTURA SUSPENDIDA 2 lados S90T, 1 pata para fijacion al suelo cm. 200x 200x 90h		4.695,00 136 / 2,79
SB99T-2,4 01599240	cm. 240x 200x 90h		5.112,00 149 / 3,33
SB99T-2,8 01599280	STRUTTURA SBALZO 2 LATI SERIE 90T, 2 PIEDI PER FISSAGGIO A TERRA EN CANTILEVER STRUCTURE 2 sides S90T, 2 feet for ground fixing • DE BRÜCKENSTRUKTURE 2 seiten S90T, 2 stehern für bodenverankerung • FR STRUCTURE SUSPENDUES 2 cotés S90T, 2 pieds pour le fixage au sol • ES ESTRUCTURA SUSPENDIDA 2 lados S90T, 2 patas para fijacion al suelo cm. 280x 200x 90h		7.052,00 226 / 3,86

STRUTTURE SBALZO 2 LATI S90

MOD. _____
COD. _____

DESCRIZIONE/DESCRIPTION/BEZEICHNUNG/DESCRIPTION/DESCRIPCIÓN
DIMENSIONI/DIMENSIONS/ABMESSUNGEN/DIMENSIONS/DIMENSIONES

POTENZA/POWER/LEISTUNG/PUISSANCE/POTENCIA
VOLTAGGIO/VOLTAGE/SPANNUNG/VOLTAGE/VOLTAJE

↓ kW kcal/h
↗ kW V~ Hz

PREZZO/PRICE
PREIS/PRIX/PRECIO
KG / M³



SB99T-3,2 01599320	cm. 320x 200x 90h		7.468,00 257 / 4,39
SB99T-3,6 01599360	cm. 360x 200x 90h		7.885,00 281 / 4,92
SB99T-4,0 01599400	cm. 400x 200x 90h		8.301,00 305 / 5,45
SB99T-4,4 01599440	cm. 440x 200x 90h		8.714,00 336 / 5,99
SB99T-4,8 01599480	cm. 480x 200x 90h		9.130,00 360 / 6,52
SB99T-5,2 01599520	cm. 520x 200x 90h		9.547,00 391 / 7,05
SB99T-5,6 01599560	cm. 560x 200x 90h		9.963,00 415 / 7,58
SB99T-6,0 01599600	cm. 600x 200x 90h		10.379,00 440 / 8,11
SB70T-2,0 01507200	STRUTTURA SBALZO 1 LATO SERIE 70T, 1 PIEDE PER FISSAGGIO A TERRA EN CANTILEVER STRUCTURE 1 side S70T, 1 foot for ground fixing • DE BRÜCKENSTRUKTURE 1 seite S70T, 1 steher für bodenverankerung • FR STRUCTURE SUSPENDUES 1 coté S70T, 1 pied pour le fixage au sol • ES ESTRUCTURA SUSPENDIDA 1 lado S70T, 1 pata para fijacion al suelo cm. 200x 93,6x 90h		4.248,00 110 / 1,32
SB70T-2,4 01507240	cm. 240x 93,6x 90h		4.560,00 120 / 1,58
SB70T-2,8 01507280	STRUTTURA SBALZO 1 LATO SERIE 70T, 2 PIEDI PER FISSAGGIO A TERRA EN CANTILEVER STRUCTURE 1 side S70T, 2 feet for ground fixing • DE BRÜCKENSTRUKTURE 1 seite S70T, 2 steher für bodenverankerung • FR STRUCTURE SUSPENDUES 1 coté S70T, 2 pieds pour le fixage au sol • ES ESTRUCTURA SUSPENDIDA 1 lado S70T, 2 patas para fijacion al suelo cm. 280x 93,6x 90h		6.456,00 191 / 1,83
SB70T-3,2 01507320	cm. 320x 93,6x 90h		6.768,00 217 / 2,08
SB70T-3,6 01507360	cm. 360x 93,6x 90h		7.080,00 238 / 2,33
SB70T-4,0 01507400	cm. 400x 93,6x 90h		7.393,00 259 / 2,58
SB70T-4,4 01507440	cm. 440x 93,6x 90h		7.705,00 285 / 2,84
SB70T-4,8 01507480	cm. 480x 93,6x 90h		8.017,00 306 / 3,09
SB70T-5,2 01507520	cm. 520x 93,6x 90h		8.331,00 332 / 3,34

STRUTTURE SBALZO 1 LATO S70

MOD. _____
COD. _____

DESCRIZIONE/DESCRIPTION/BEZEICHNUNG/DESCRIPTION/DESCRIPCIÓN
DIMENSIONI/DIMENSIONS/ABMESSUNGEN/DIMENSIONS/DIMENSIONES

POTENZA/POWER/LEISTUNG/PUISSANCE/POTENCIA
VOLTAGGIO/VOLTAGE/SPANNUNG/VOLTAGE/VOLTAJE

↓ kW kcal/h
↗ kW V~ Hz

PREZZO/PRICE
PREIS/PRIX/PRECIO
KG / M³



SB70T-5,6 cm. 560x 93,6x 90h **8.643,00**
01507560 353 / 3,59

SB70T-6,0 cm. 600x 93,6x 90h **8.956,00**
01507600 374 / 3,84



SB77T-2,0 **STRUTTURA SBALZO 2 LATI SERIE 70T, 1 PIEDE PER** **4.695,00**
01577200 **FISSAGGIO A TERRA** 130 / 2,21
EN CANTILEVER STRUCTURE 2 sides S70T, 1 foot for ground
fixing • **DE** BRÜCKENSTRUKTURE 2 seiten S70T, 1 steher für
bodenverankerung • **FR** STRUCTURE SUSPENDUES 2 cotés S70T, 1 pied
pour le fixation au sol • **ES** ESTRUCTURA SUSPENDIDA 2 lados S70T, 1
pata para fijacion al suelo

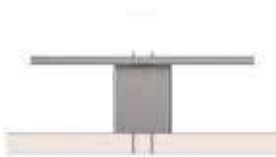

SB77T-2,4 cm. 240x 161x 90h **5.112,00**
01577240 143 / 2,63

SB77T-2,8 **STRUTTURA SBALZO 2 LATI SERIE 70T, 2 PIEDI PER** **7.052,00**
01577280 **FISSAGGIO A TERRA** 218 / 3,05
EN CANTILEVER STRUCTURE 2 sides S70T, 2 feet for ground fixing • **DE**
BRÜCKENSTRUKTURE 2 seiten S70T, 2 stehern für bodenverankerung
• **FR** STRUCTURE SUSPENDUES 2 cotés S70T, 2 pieds pour le fixation au
sol • **ES** ESTRUCTURA SUSPENDIDA 2 lados S70T, 2 patas para fijacion
al suelo

SB77T-3,2 cm. 320x 161x 90h **7.468,00**
01577320 248 / 3,47

SB77T-3,6 cm. 360x 161x 90h **7.885,00**
01577360 272 / 3,89

SB77T-4,0 cm. 400x 161x 90h **8.301,00**
01577400 296 / 4,31

SB77T-4,4 cm. 440x 161x 90h **8.714,00**
01577440 326 / 4,73

SB77T-4,8 cm. 480x 161x 90h **9.130,00**
01577480 350 / 5,15

SB77T-5,2 cm. 520x 161x 90h **9.547,00**
01577520 380 / 5,57

SB77T-5,6 cm. 560x 161x 90h **9.963,00**
01577560 404 / 5,99

SB77T-6,0 cm. 600x 161x 90h **10.379,00**
01577600 428 / 6,41

STRUTTURE SBALZO 2 LATI S90 E 70

MOD. _____
COD. _____



DESCRIZIONE/DESCRIPTION/BEZEICHNUNG/DESCRIPTION/DESCRIPCIÓN
DIMENSIONI/DIMENSIONS/ABMESSUNGEN/DIMENSIONS/DIMENSIONES

POTENZA/POWER/LEISTUNG/PUISSANCE/POTENCIA
VOLTAGGIO/VOLTAGE/SPANNUNG/VOLTAGE/VOLTAJE

↓ kW kcal/h
↗ kW V~ Hz

PREZZO/PRICE
PREIS/PRIX/PRECIO
KG / M³

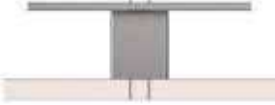

SB79T-2,0 01579200	STRUTTURA SBALZO 2 LATI SERIE 70T/90T, 1 PIEDE PER FISSAGGIO A TERRA EN CANTILEVER STRUCTURE 2 sides S70T/90T, 1 foot for ground fixing • DE BRÜCKENSTRUKTURE 2 seiten S70T/90T, 1 steher für bodenverankerung • FR STRUCTURE SUSPENDUES 2 cotés S70T/90T, 1 pied pour le fixage au sol • ES ESTRUCTURA SUSPENDIDA 2 lados S70T/90T, 1 pata para fijación al suelo cm. 200x180,5x 90h		4.695,00 133 / 2,50
SB79T-2,4 01579240	cm. 240x180,5x 90h		5.112,00 146 / 2,98
SB79T-2,8 01579280	STRUTTURA SBALZO 2 LATI SERIE 70T/90T, 2 PIEDI PER FISSAGGIO A TERRA EN CANTILEVER STRUCTURE 2 sides S70T/90T, 2 feet for ground fixing • DE BRÜCKENSTRUKTURE 2 seiten S70T/90T, 2 stehern für bodenverankerung • FR STRUCTURE SUSPENDUES 2 cotés S70T/90T, 2 pieds pour le fixage au sol • ES ESTRUCTURA SUSPENDIDA 2 lados S70T/90T, 2 patas para fijación al suelo cm. 280x180,5x 90h		7.052,00 222 / 3,45
SB79T-3,2 01579320	cm. 320x180,5x 90h		7.468,00 253 / 3,93
SB79T-3,6 01579360	cm. 360x180,5x 90h		7.885,00 277 / 4,40
SB79T-4,0 01579400	cm. 400x180,5x 90h		8.301,00 301 / 4,88
SB79T-4,4 01579440	cm. 440x180,5x 90h		8.714,00 331 / 5,36
SB79T-4,8 01579480	cm. 480x180,5x 90h		9.130,00 355 / 5,83
SB79T-5,2 01579520	cm. 520x180,5x 90h		9.547,00 386 / 6,31
SB79T-5,6 01579560	cm. 560x180,5x 90h		9.963,00 410 / 6,78
SB79T-6,0 01579600	cm. 600x180,5x 90h		10.379,00 434 / 7,26
SB90T-2,8A 01509281	STRUTTURA SBALZO 1 LATO SERIE 90T, 2 PIEDI AUTOPORTANTI EN CANTILEVER STRUCTURE 1 side S90T, 2 self-supporting feet • DE BRÜCKENSTRUKTURE 1 seite S90T, 2 stehern für selbsttragende Struktur • FR STRUCTURE SUSPENDUES 1 coté S90T, 2 pieds autoportantes • ES ESTRUCTURA SUSPENDIDA 1 lado S90T, 2 patas autoportantes cm. 280x113,1x 90h		7.807,00 194 / 2,23
SB90T-3,2A 01509321	cm. 320x113,1x 90h		8.119,00 221 / 2,54
SB90T-3,6A 01509361	cm. 360x113,1x 90h		8.433,00 242 / 2,85
SB90T-4,0A 01509401	cm. 400x113,1x 90h		8.745,00 263 / 3,16
SB90T-4,4A 01509441	cm. 440x113,1x 90h		9.057,00 290 / 3,47

STRUTTURE SBALZO 1 LATO S90 AUTOPORTANTI

MOD. COD.	DESCRIZIONE/DESCRIPTION/BEZEICHNUNG/DESCRIPTION/DESCRIPCIÓN DIMENSIONI/DIMENSIONS/ABMESSUNGEN/DIMENSIONS/DIMENSIONES	POTENZA/POWER/LEISTUNG/PUISSANCE/POTENCIA VOLTAGGIO/VOLTAGE/SPANNUNG/VOLTAGE/VOLTAJE	$\frac{kW}{kcal/h}$ $\frac{V}{Hz}$	PREZZO/PRICE PREIS/PRIX/PRECIO € KG / M ³
SB90T-4,8A 01509481	cm. 480x113,1x 90h			9.370,00 311 / 3,77
SB90T-5,2A 01509521	cm. 520x113,1x 90h			9.682,00 338 / 4,08
SB90T-5,6A 01509561	cm. 560x113,1x 90h			9.996,00 359 / 4,39
SB90T-6,0A 01509601	cm. 600x113,1x 90h			10.308,00 380 / 4,70
SB99T-2,8A 01599281	STRUTTURA SBALZO 2 LATI SERIE 90T, 2 PIEDI AUTOPORTANTI EN CANTILEVER STRUCTURE 2 sides S90T, 2 self-supporting feet • DE BRÜCKENSTRUKTURE 2 seiten S90T, 2 stehern für selbsttragende Struktur • FR STRUCTURE SUSPENDUES 2 cotés S90T, 2 pieds autoportantes • ES ESTRUCTURA SUSPENDIDA 2 lados S90T, 2 patas autoportantes cm. 280x 200x 90h			8.611,00 226 / 3,86
SB99T-3,2A 01599321	cm. 320x 200x 90h			9.029,00 257 / 4,39
SB99T-3,6A 01599361	cm. 360x 200x 90h			9.444,00 281 / 4,92
SB99T-4,0A 01599401	cm. 400x 200x 90h			9.859,00 305 / 5,45
SB99T-4,4A 01599441	cm. 440x 200x 90h			10.277,00 336 / 5,99
SB99T-4,8A 01599481	cm. 480x 200x 90h			10.689,00 360 / 6,52
SB99T-5,2A 01599521	cm. 520x 200x 90h			11.107,00 391 / 7,05
SB99T-5,6A 01599561	cm. 560x 200x 90h			11.524,00 415 / 7,58
SB99T-6,0A 01599601	cm. 600x 200x 90h			11.939,00 440 / 8,11
SB70T-2,8A 01507281	STRUTTURA SBALZO 1 LATO SERIE 70T, 2 PIEDI AUTOPORTANTI EN CANTILEVER STRUCTURE 1 side S70T, 2 self-supporting feet • DE BRÜCKENSTRUKTURE 1 seite S70T, 2 stehern für selbsttragende Struktur • FR STRUCTURE SUSPENDUES 1 coté S70T, 2 pieds autoportantes • ES ESTRUCTURA SUSPENDIDA 1 lado S70T, 2 patas autoportantes cm. 280x 93,6x 90h			7.807,00 191 / 1,83
SB70T-3,2A 01507321	cm. 320x 93,6x 90h			8.119,00 217 / 2,08
SB70T-3,6A 01507361	cm. 360x 93,6x 90h			8.433,00 238 / 2,33
SB70T-4,0A 01507401	cm. 400x 93,6x 90h			8.745,00 259 / 2,58

STRUTTURE SBALZO 1 LATO S70 AUTOPORTANTI

MOD. _____
COD. _____

DESCRIZIONE/DESCRIPTION/BEZEICHNUNG/DESCRIPTION/DESCRIPCIÓN
DIMENSIONI/DIMENSIONS/ABMESSUNGEN/DIMENSIONS/DIMENSIONES

POTENZA/POWER/LEISTUNG/PUISSANCE/POTENCIA
VOLTAGGIO/VOLTAGE/SPANNUNG/VOLTAGE/VOLTAJE

$\frac{kW}{kcal/h}$ $\frac{V}{Hz}$

PREZZO/PRICE
PREIS/PRIX/PRECIO
KG / M³



SB70T-4,4A cm. 440x 93,6x 90h 01507441		9.057,00 285 / 2,84
SB70T-4,8A cm. 480x 93,6x 90h 01507481		9.370,00 306 / 3,09
SB70T-5,2A cm. 520x 93,6x 90h 01507521		9.682,00 332 / 3,34
SB70T-5,6A cm. 560x 93,6x 90h 01507561		9.996,00 353 / 3,59
SB70T-6,0A cm. 600x 93,6x 90h 01507601		10.308,00 374 / 3,84

SB77T-2,8A STRUTTURA SBALZO 2 LATI SERIE 70T, 2 PIEDI AUTOPORTANTI 01577281		8.611,00 218 / 3,05
EN CANTILEVER STRUCTURE 2 sides S70T, 2 self-supporting feet • DE BRÜCKENSTRUKTURE 2 seiten S70T, 2 stehern für selbsttragende Struktur • FR STRUCTURE SUSPENDUES 2 cotés S70T, 2 pieds autoportantes • ES ESTRUCTURA SUSPENDIDA 2 lados S70T, 2 patas autoportantes cm. 280x 161x 90h		

SB77T-3,2A cm. 320x 161x 90h 01577321		9.029,00 248 / 3,47
SB77T-3,6A cm. 360x 161x 90h 01577361		9.444,00 272 / 3,89
SB77T-4,0A cm. 400x 161x 90h 01577401		9.859,00 296 / 4,31
SB77T-4,4A cm. 440x 161x 90h 01577441		10.277,00 326 / 4,73
SB77T-4,8A cm. 480x 161x 90h 01577481		10.689,00 350 / 5,15
SB77T-5,2A cm. 520x 161x 90h 01577521		11.107,00 380 / 5,57
SB77T-5,6A cm. 560x 161x 90h 01577561		11.524,00 404 / 5,99
SB77T-6,0A cm. 600x 161x 90h 01577601		11.939,00 428 / 6,41

SB79T-2,8A STRUTTURA SBALZO 2 LATI SERIE 70T/90T, 2 PIEDI AUTOPORTANTI 01579281		8.611,00 222 / 3,45
EN CANTILEVER STRUCTURE 2 sides S70T/90T, 2 self-supporting feet • DE BRÜCKENSTRUKTURE 2 seiten S70T/90T, 2 stehern für selbsttragende Struktur • FR STRUCTURE SUSPENDUES 2 cotés S70T/90T, 2 pieds autoportantes • ES ESTRUCTURA SUSPENDIDA 2 lados S70T/90T, 2 patas autoportantes cm. 280x180,5x 90h		

SB79T-3,2A cm. 320x180,5x 90h 01579321		9.029,00 253 / 3,93
SB79T-3,6A cm. 360x180,5x 90h 01579361		9.444,00 277 / 4,40

STRUTTURE SBALZO 2 LATI S90 E 70 AUTOPORTANTI

MOD. _____
COD. _____

DESCRIZIONE/DESCRIPTION/BEZEICHNUNG/DESCRIPTION/DESCRIPCIÓN
DIMENSIONI/DIMENSIONS/ABMESSUNGEN/DIMENSIONS/DIMENSIONES

POTENZA/POWER/LEISTUNG/PUISSANCE/POTENCIA
VOLTAGGIO/VOLTAGE/SPANNUNG/VOLTAGE/VOLTAJE

⚡ kW kcal/h
⚡ kw V~ Hz

PREZZO/PRICE
PREIS/PRIX/PRECIO
KG / M³



SB79T-4,0A cm. 400x180,5x 90h
01579401



9.859,00
301 / 4,88

SB79T-4,4A cm. 440x180,5x 90h
01579441

10.277,00
331 / 5,36

SB79T-4,8A cm. 480x180,5x 90h
01579481

10.689,00
355 / 5,83

SB79T-5,2A cm. 520x180,5x 90h
01579521

11.107,00
386 / 6,31

SB79T-5,6A cm. 560x180,5x 90h
01579561

11.524,00
410 / 6,78

SB79T-6,0A cm. 600x180,5x 90h
01579601

11.939,00
434 / 7,26

SOVMOB SOVRAPPREZZO PER MONTAGGIO DI UN APPARECCHIO A MOBILE. ATTENZIONE: IN CASO DI MONTAGGIO SU STRUTTURE DA 2,0/2,4 MT., QUEST'ULTIME SARANNO PRODOTTE CON 2 PIEDI



321,00
/

EN OVERPRICE FOR ASSEMBLY OF A STAND UNIT.
ATTENTION: IN CASE OF MOUNTING OVER STRUCTURE FOR 2,0/2,4 mt, THE LATTER WILL BE PRODUCED WITH TWO FEET. • **DE** PREISERHÖRUNG FÜR DIE MONTAGE VON EINE STAND GERAT.
ACHTUNG: FÜR DEN EINBAU AUF STRUKTUREN VON 2,0/2,4 Meter, WERDEN DIESE MIT 2 FUSSE GELIEFERT. • **FR** AUGMENTATION DE PRIX POUR L'ASSEMBLAGE D'UN APPAREIL SUR PLACARD.
ATTENTION: EN CAS DE MONTAGE SUR STRUCTURES DE 2,0 ET 2,4 mt., CES STRUCTURES SERONT PRODUITE AVEC 2 PIEDS. • **ES** INCREMENTO DE PRECIOS POR LE MONTAJE DE UN APPARATO SOBRE UN MEUBLE.
ATENCION: EN CASO DE MONTAJE SU ESTRUCTURAS DE MEDIDA 2,0m Y 2,4m, ESAS SERAN DE 2 PATAS

CORRIMANO CORRIMANO
EN HANDRAIL • **DE** HAND LAUF • **FR** MAIN COURANTE • **ES** PASAMANO
€/m



395,00
/

SB90-FDX **TESTATA 1 LATO SERIE 90 DX**
01609000 **EN** Head 1 side S90 DX • **DE** Abschluss element 1 seite S90 DX • **FR** Element de jonction 1 coté S90 DX • **ES** Embellecedor 1 lado S90 DX
cm. 0,2x131,1x 90h

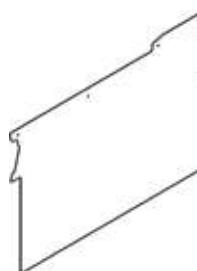

411,00
13.4 / 0,02

SB90-FPDX **TESTATA 1 LATO SERIE 90 DX CON PIANETTO**
01609010 **EN** Head 1 side S90 DX with shelf • **DE** Abschluss element 1 seite S90 DX mit ablage • **FR** Element de jonction 1 coté S90 DX avec etagere
• **ES** Embellecedor 1 lado S90 DX con estante
cm. 20x131,1x 90h

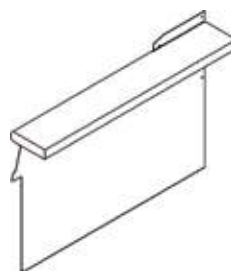

743,00
18.8 / 0,38

TESTATE 1 LATO S90

MOD. _____
COD. _____

DESCRIZIONE/DESCRIPTION/BEZEICHNUNG/DESCRIPTION/DESCRIPCIÓN
DIMENSIONI/DIMENSIONS/ABMESSUNGEN/DIMENSIONS/DIMENSIONES

POTENZA/POWER/LEISTUNG/PUISSANCE/POTENCIA
VOLTAGGIO/VOLTAGE/SPANNUNG/VOLTAGE/VOLTAJE

↓ kW kcal/h
↗ kW V~ Hz

PREZZO/PRICE
PREIS/PRIX/PRECIO
KG / M³



SB90-FSX
01609001

TESTATA 1 LATO SERIE 90 SX
EN Head 1 side S90 SX • **DE** Abschluss element 1 seite S90 SX • **FR** Element de jonction 1 coté S90 SX • **ES** Embellecedor 1 lado S90 SX
cm. 0,2x131,1x 90h

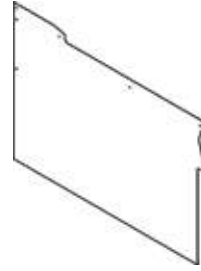

411,00
13.4 / 0,02

SB90-FPSX
01609011

TESTATA 1 LATO SERIE 90 SX CON PIANETTO
EN Head 1 side S90 SX with shelf • **DE** Abschluss element 1 seite S90 SX mit ablage • **FR** Element de jonction 1 coté S90 SX avec etagere • **ES** Embellecedor 1 lado S90 SX con estante
cm. 20x131,1x 90h

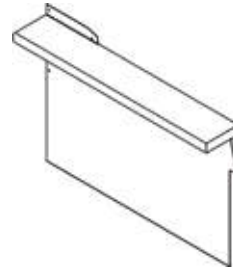

743,00
18.8 / 0,38

SB99-F
01699002

TESTATA 2 LATI SERIE 90
EN Head 2 sides S90 • **DE** Abschluss element seiten S90 • **FR** Element de jonction 2 cotés S90 • **ES** Embellecedor 2 lados S90
cm. 0,2x 200x 90h

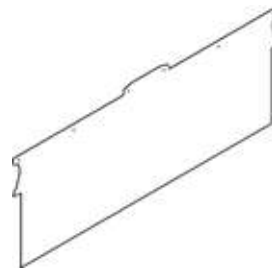

615,00
23.7 / 0,04

SB99-FP
01699012

TESTATA 2 LATI SERIE 90 CON PIANETTO
EN Head 2 sides S90 with shelf • **DE** Abschluss element seiten S90 mit ablage • **FR** Element de jonction 2 cotés S90 avec etagere • **ES** Embellecedor 2 lados S90 con estante
cm. 20x 200x 90h

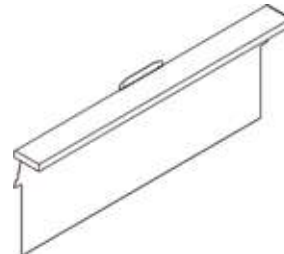

992,00
33.3 / 0,66

SB90T-FDX
01709000

TESTATA 1 LATO SERIE 90TOP DX
EN Head 1 side S90TOP DX • **DE** Abschluss element 1 seite S90TOP DX • **FR** Element de jonction 1 coté S90TOP DX • **ES** Embellecedor 1 lado S90TOP DX
cm. 0,2x131,1x 36h

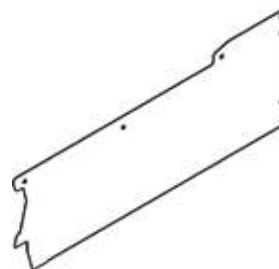

282,00
5.1 / 0,01

SB90T-FPDX
01709010

TESTATA 1 LATO SERIE 90TOP DX CON PIANETTO
EN Head 1 side S90TOP DX with shelf • **DE** Abschluss element 1 seite S90TOP DX mit ablage • **FR** Element de jonction 1 coté S90TOP DX avec etagere • **ES** Embellecedor 1 lado S90TOP DX con estante
cm. 20x131,1x 36h

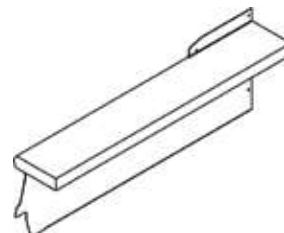

615,00
10.5 / 0,21

TESTATE 1 LATO S90

MOD. _____
COD. _____

DESCRIZIONE/DESCRIPTION/BEZEICHNUNG/DESCRIPTION/DESCRIPCIÓN
DIMENSIONI/DIMENSIONS/ABMESSUNGEN/DIMENSIONS/DIMENSIONES

POTENZA/POWER/LEISTUNG/PUISSANCE/POTENCIA
VOLTAGGIO/VOLTAGE/SPANNUNG/VOLTAGE/VOLTAJE

⚡ kW kcal/h
⚡ kW V~ Hz

PREZZO/PRICE
PREIS/PRIX/PRECIO
KG / M³



SB90T-FSX
01709001

TESTATA 1 LATO SERIE 90TOP SX
EN Head 1 side S90TOP SX • **DE** Abschluss element 1 seite S90TOP SX
• **FR** Element de jonction 1 coté S90TOP SX • **ES** Embellecedor 1 lado S90TOP SX
cm. 0,2x131,1x 36h

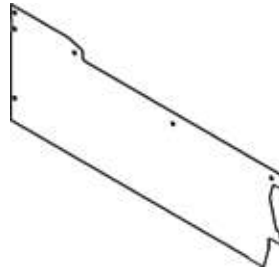

282,00
5.2 / 0,01

SB90T-FPSX
01709011

TESTATA 1 LATO SERIE 90TOP SX CON PIANETTO
EN Head 1 side S90TOP SX with shelf • **DE** Abschluss element 1 seite S90TOP SX mit ablage • **FR** Element de jonction 1 coté S90TOP SX avec etagere • **ES** Embellecedor 1 lado S90TOP SX con estante
cm. 20x131,1x 36h

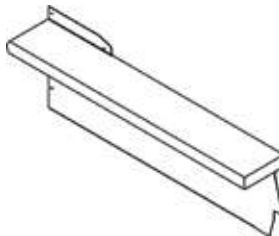

615,00
10.7 / 0,21

SB99T-F
01799002

TESTATA 2 LATI SERIE 90TOP
EN Head 2 sides S90TOP • **DE** Abschluss element seiten S90TOP • **FR** Element de jonction 2 cotés S90TOP • **ES** Embellecedor 2 lados S90TOP
cm. 0,2x 200x 36h

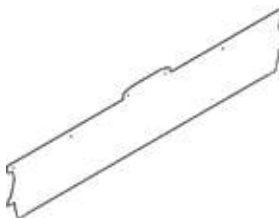

377,00
9.3 / 0,02

SB99T-FP
01799012

TESTATA 2 LATI SERIE 90TOP CON PIANETTO
EN Head 2 sides S90TOP with shelf • **DE** Abschluss element seiten S90TOP mit ablage • **FR** Element de jonction 2 cotés S90TOP avec etagere • **ES** Embellecedor 2 lados S90TOP con estante
cm. 20x 200x 36h



755,00
18.9 / 0,37

SB70-FDX
01607000

TESTATA 1 LATO SERIE 70 DX
EN Head 1 side S70 DX • **DE** Abschluss element 1 seite S70 DX • **FR** Element de jonction 1 coté S70 DX • **ES** Embellecedor 1 lado S70 DX
cm. 0,2x 93,6x 90h

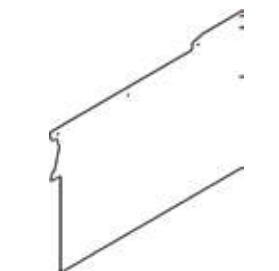

371,00
11 / 0,02

SB70-FPDX
01607010

TESTATA 1 LATO SERIE 70 DX CON PIANETTO
EN Head 1 side S70 DX with shelf • **DE** Abschluss element 1 seite S70 DX mit ablage • **FR** Element de jonction 1 coté S70 DX avec etagere • **ES** Embellecedor 1 lado S70 DX con estante
cm. 20x 93,6x 90h

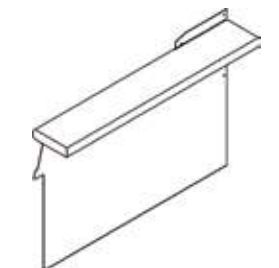

690,00
15.5 / 0,32

TESTATE 1 LATO S70

MOD. _____
COD. _____

DESCRIZIONE/DESCRIPTION/BEZEICHNUNG/DESCRIPTION/DESCRIPCIÓN
DIMENSIONI/DIMENSIONS/ABMESSUNGEN/DIMENSIONS/DIMENSIONES

POTENZA/POWER/LEISTUNG/PUISSANCE/POTENCIA
VOLTAGGIO/VOLTAGE/SPANNUNG/VOLTAGE/VOLTAJE

↓ kW kcal/h
↗ kW V~ Hz

PREZZO/PRICE
PREIS/PRIX/PRECIO
KG / M³



SB70-FSX
01607001

TESTATA 1 LATO SERIE 70 SX
EN Head 1 side S70 SX • **DE** Abschluss element 1 seite S70 SX • **FR** Element de jonction 1 coté S70 SX • **ES** Embellecedor 1 lado S70 SX
cm. 0,2x 93,6x 90h

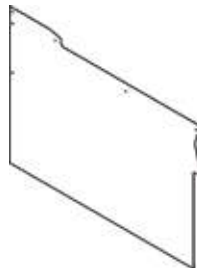

371,00
11 / 0,02

SB70-FPSX
01607011

TESTATA 1 LATO SERIE 70 SX CON PIANETTO
EN Head 1 side S70 SX with shelf • **DE** Abschluss element 1 seite S70 SX mit ablage • **FR** Element de jonction 1 coté S70 SX avec etagere • **ES** Embellecedor 1 lado S70 SX con estante
cm. 20x 93,6x 90h

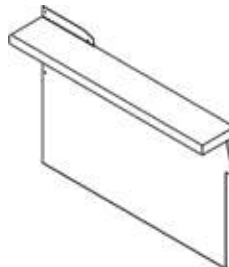

690,00
15.5 / 0,32

SB77-F
01677002

TESTATA 2 LATI SERIE 70
EN Head 2 sides S70 • **DE** Abschluss element seiten S70 • **FR** Element de jonction 2 cotés S70 • **ES** Embellecedor 2 lados S70
cm. 0,2x 161x 90h

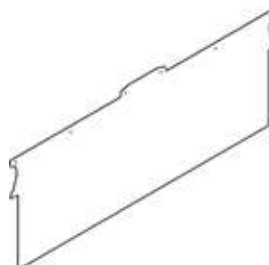

520,00
18.9 / 0,04

SB77-FP
01677012

TESTATA 2 LATI SERIE 70 CON PIANETTO
EN Head 2 sides S70 with shelf • **DE** Abschluss element seiten S70 mit ablage • **FR** Element de jonction 2 cotés S70 avec etagere • **ES** Embellecedor 2 lados S70 con estante
cm. 20x 161x 90h

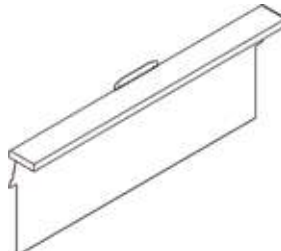

875,00
26.6 / 0,54

SB70T-FDX
01707000

TESTATA 1 LATO SERIE 70TOP DX
EN Head 1 side S70TOP DX • **DE** Abschluss element 1 seite S70TOP DX • **FR** Element de jonction 1 coté S70TOP DX • **ES** Embellecedor 1 lado S70TOP DX
cm. 0,2x 93,6x 36h

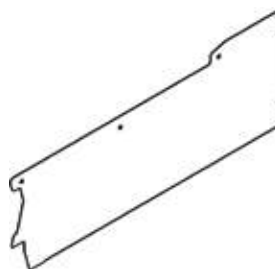

262,00
4.2 / 0,01

SB70T-FPDX
01707010

TESTATA 1 LATO SERIE 70TOP DX CON PIANETTO
EN Head 1 side S70TOP DX with shelf • **DE** Abschluss element 1 seite S70TOP DX mit ablage • **FR** Element de jonction 1 coté S70TOP DX avec etagere • **ES** Embellecedor 1 lado S70TOP DX con estante
cm. 20x 93,6x 36h

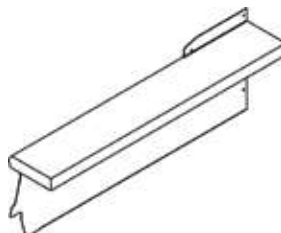

578,00
8.6 / 0,18

TESTATE 1 LATO S70

MOD.
COD.

DESCRIZIONE/DESCRIPTION/BEZEICHNUNG/DESCRIPTION/DESCRIPCIÓN
DIMENSIONI/DIMENSIONS/ABMESSUNGEN/DIMENSIONS/DIMENSIONES

POTENZA/POWER/LEISTUNG/PUISSANCE/POTENCIA
VOLTAGGIO/VOLTAGE/SPANNUNG/VOLTAGE/VOLTAJE

↓ kW kcal/h
↗ kW
V~
Hz

PREZZO/PRICE
PREIS/PRIX/PRECIO
KG / M³



SB70T-FSX
01707001

TESTATA 1 LATO SERIE 70TOP SX
EN Head 1 side S70TOP SX • **DE** Abschluss element 1 seite S70TOP SX
• **FR** Element de jonction 1 coté S70TOP SX • **ES** Embellecedor 1 lado S70TOP SX
cm. 0,2x 93,6x 36h

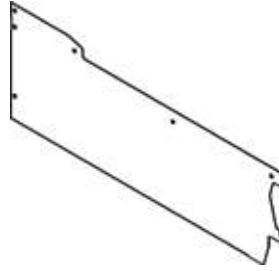

262,00
4.3 / 0,01

SB70T-FPSX
01707011

TESTATA 1 LATO SERIE 70TOP SX CON PIANETTO
EN Head 1 side S70TOP SX with shelf • **DE** Abschluss element 1 seite S70TOP SX mit ablage • **FR** Element de jonction 1 coté S70TOP SX avec etagere • **ES** Embellecedor 1 lado S70TOP SX con estante
cm. 20x 93,6x 36h

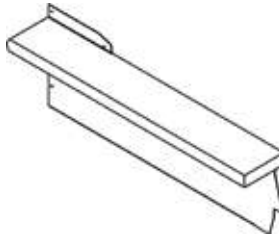

578,00
8.8 / 0,18

SB77T-F
01777002

TESTATA 2 LATI SERIE 70TOP
EN Head 2 sides S70TOP • **DE** Abschluss element seiten S70TOP • **FR** Element de jonction 2 cotés S70TOP • **ES** Embellecedor 2 lados S70TOP
cm. 0,2x 161x 36h

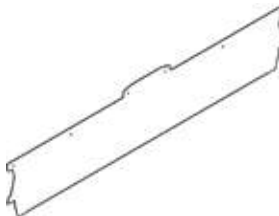

329,00
7.4 / 0,02

SB77T-FP
01777012

TESTATA 2 LATI SERIE 70TOP CON PIANETTO
EN Head 2 sides S70TOP with shelf • **DE** Abschluss element seiten S70TOP mit ablage • **FR** Element de jonction 2 cotés S70TOP avec etagere • **ES** Embellecedor 2 lados S70TOP con estante
cm. 20x 161x 36h



685,00
15.1 / 0,30

SB79-FDX
01679000

TESTATA 2 LATI SERIE 70/90 DX
EN Head 2 sides S70/S90 DX • **DE** Abschluss element seiten S70/S90 DX • **FR** Element de jonction 2 cotés S70/S90 DX • **ES** Embellecedor 2 lados S70/S90 DX
cm. 0,2x180,5x 90h

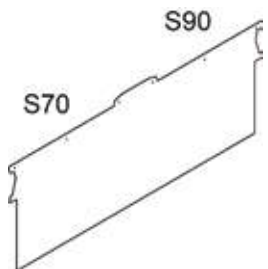

567,00
21.3 / 0,04

SB79-FPDX
01679010

TESTATA 2 LATI SERIE 70/90 DX CON PIANETTO
EN Head 2 sides S70/S90 DX with shelf • **DE** Abschluss element seiten S70/S90 DX mit ablage • **FR** Element de jonction 2 cotés S70/S90 DX avec etagere • **ES** Embellecedor 2 lados S70/S90 DX con estante
cm. 20x180,5x 90h

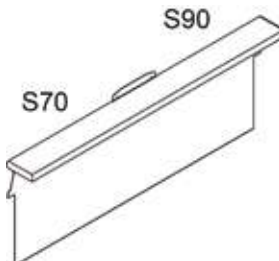

930,00
30 / 0,60

TESTATE 2 LATI S90 E 70

MOD. _____
COD. _____

DESCRIZIONE/DESCRIPTION/BEZEICHNUNG/DESCRIPTION/DESCRIPCIÓN
DIMENSIONI/DIMENSIONS/ABMESSUNGEN/DIMENSIONS/DIMENSIONES

POTENZA/POWER/LEISTUNG/PUISSANCE/POTENCIA
VOLTAGGIO/VOLTAGE/SPANNUNG/VOLTAGE/VOLTAJE

↓ kW kcal/h ↗ kW V~ Hz

PREZZO/PRICE
PREIS/PRIX/PRECIO
KG / M³



SB79-FSX
01679001

TESTATA 2 LATI SERIE 70/90 SX
EN Head 2 sides S70/S90 SX • **DE** Abschluss element seiten S70/S90 SX • **FR** Element de jonction 2 cotés S70/S90 SX • **ES** Embellecedor 2 lados S70/S90 SX
cm. 0,2x180,5x 90h

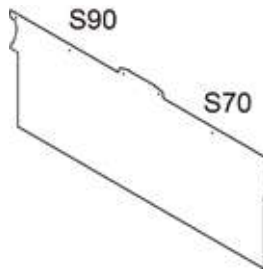

567,00
21.3 / 0,04

SB79-FPSX
01679011

TESTATA 2 LATI SERIE 70/90 SX CON PIANETTO
EN Head 2 sides S70/S90 SX with shelf • **DE** Abschluss element seiten S70/S90 SX mit ablage • **FR** Element de jonction 2 cotés S70/S90 SX avec etagere • **ES** Embellecedor 2 lados S70/S90 SX con estante
cm. 20x180,5x 90h

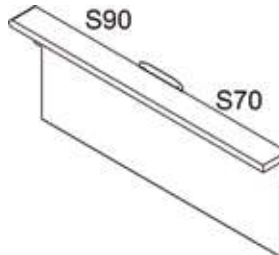

930,00
30 / 0,60

SB79T-FDX
01779000

TESTATA 2 LATI SERIE 70TOP/90TOP DX
EN Head 2 sides S70TOP/S90TOP DX • **DE** Abschluss element seiten S70TOP/S90TOP DX • **FR** Element de jonction 2 cotés S70TOP/S90TOP DX • **ES** Embellecedor 2 lados S70TOP/S90TOP DX
cm. 0,2x180,5x 36h

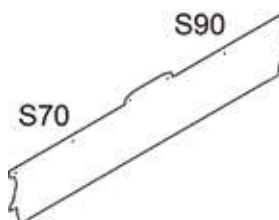

354,00
8.4 / 0,02

SB79T-FPDX
01779010

TESTATA 2 LATI SERIE 70TOP/90TOP DX CON PIANETTO
EN Head 2 sides S70TOP/S90TOP DX with shelf • **DE** Abschluss element seiten S70TOP/S90TOP DX mit ablage • **FR** Element de jonction 2 cotés S70TOP/S90TOP DX avec etagere • **ES** Embellecedor 2 lados S70TOP/S90TOP DX con estante
cm. 20x180,5x 36h

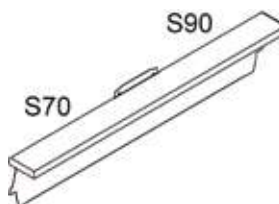

719,00
17 / 0,33

SB79T-FSX
01779001

TESTATA 2 LATI SERIE 70TOP/90TOP SX
EN Head 2 sides S70TOP/S90TOP SX • **DE** Abschluss element seiten S70TOP/S90TOP SX • **FR** Element de jonction 2 cotés S70TOP/S90TOP SX • **ES** Embellecedor 2 lados S70TOP/S90TOP SX
cm. 0,2x180,5x 36h

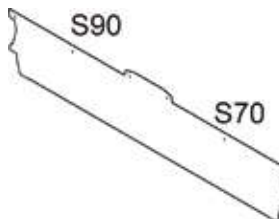

354,00
8.4 / 0,02

SB79T-FPSX
01779011

TESTATA 2 LATI SERIE 70TOP/90TOP SX CON PIANETTO
EN Head 2 sides S70TOP/S90TOP SX with shelf • **DE** Abschluss element seiten S70TOP/S90TOP SX mit ablage • **FR** Element de jonction 2 cotés S70TOP/S90TOP SX avec etagere • **ES** Embellecedor 2 lados S70TOP/S90TOP SX con estante
cm. 20x180,5x 36h

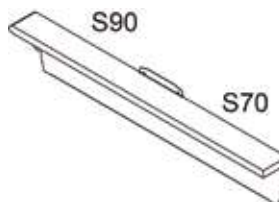

719,00
17 / 0,33

SB99TM-FDX
01899000

TESTATA 2 LATI SERIE 90TOP/90 DX
EN Head 2 sides S90TOP/S90 DX • **DE** Abschluss element seiten S90TOP/S90 DX • **FR** Element de jonction 2 cotés S90TOP/S90 DX • **ES** Embellecedor 2 lados S90TOP/S90 DX
cm. 0,2x 200x 90h

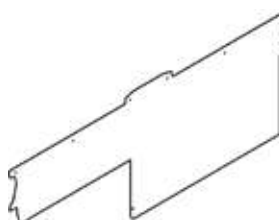

509,00
17.3 / 0,04

TESTATE 2 LATI S90 E 70

MOD. _____
COD. _____

DESCRIZIONE/DESCRIPTION/BEZEICHNUNG/DESCRIPTION/DESCRIPCIÓN
DIMENSIONI/DIMENSIONS/ABMESSUNGEN/DIMENSIONS/DIMENSIONES

POTENZA/POWER/LEISTUNG/PUISSANCE/POTENCIA
VOLTAGGIO/VOLTAGE/SPANNUNG/VOLTAGE/VOLTAJE

↓ kW kcal/h
↗ kW V~ Hz

PREZZO/PRICE
PREIS/PRIX/PRECIO
KG / M³



SB99TM-FPDX TESTATA 2 LATI SERIE 90TOP/90 DX CON PIANETTO

01899010 **EN** Head 2 sides S90TOP/S90 DX with shelf • **DE** Abschluss element seiten S90TOP/S90 DX mit ablage • **FR** Element de jonction 2 cotés S90TOP/S90 DX avec etagere • **ES** Embellecedor 2 lados S90TOP/S90 DX con estante
cm. 20x 200x 90h

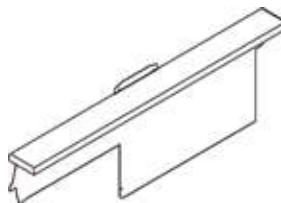

892,00
26.9 / 0,66

SB99TM-FSX TESTATA 2 LATI SERIE 90TOP/90 SX

01899001 **EN** Head 2 sides S90TOP/S90 SX • **DE** Abschluss element seiten S90TOP/S90 SX • **FR** Element de jonction 2 cotés S90TOP/S90 SX • **ES** Embellecedor 2 lados S90TOP/S90 SX
cm. 0,2x 200x 90h

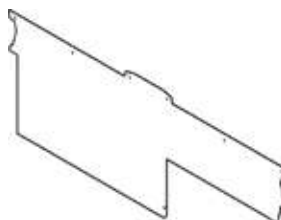

509,00
17.3 / 0,04

SB99TM-FPSX TESTATA 2 LATI SERIE 90TOP/90 SX CON PIANETTO

01899011 **EN** Head 2 sides S90TOP/S90 SX with shelf • **DE** Abschluss element seiten S90TOP/S90 SX mit ablage • **FR** Element de jonction 2 cotés S90TOP/S90 SX avec etagere • **ES** Embellecedor 2 lados S90TOP/S90 SX con estante
cm. 20x 200x 90h

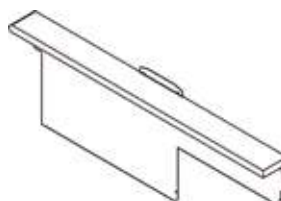

892,00
26.9 / 0,66

SB77TM-FDX TESTATA 2 LATI SERIE 70TOP/70 DX

01877000 **EN** Head 2 sides S70TOP/S70 DX • **DE** Abschluss element seiten S70TOP/S70 DX • **FR** Element de jonction 2 cotés S70TOP/S70 DX • **ES** Embellecedor 2 lados S70TOP/S70 DX
cm. 0,2x 161x 36h

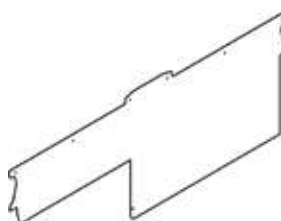

443,00
13.8 / 0,04

SB77TM-FPDX TESTATA 2 LATI SERIE 70TOP/70 DX CON PIANETTO

01877010 **EN** Head 2 sides S70TOP/S70 DX with shelf • **DE** Abschluss element seiten S70TOP/S70 DX mit ablage • **FR** Element de jonction 2 cotés S70TOP/S70 DX avec etagere • **ES** Embellecedor 2 lados S70TOP/S70 DX con estante
cm. 20x 161x 36h

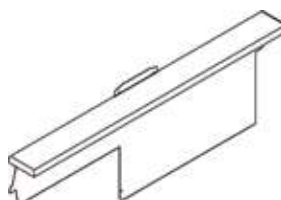

796,00
21.5 / 0,54

SB77TM-FSX TESTATA 2 LATI SERIE 70TOP/70 SX

01877001 **EN** Head 2 sides S70TOP/S70 SX • **DE** Abschluss element seiten S70TOP/S70 SX • **FR** Element de jonction 2 cotés S70TOP/S70 SX • **ES** Embellecedor 2 lados S70TOP/S70 SX
cm. 0,2x 161x 36h

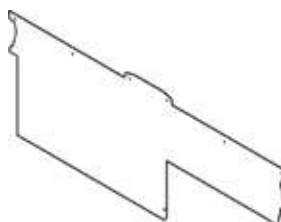

443,00
13.8 / 0,04

SB77TM-FPSX TESTATA 2 LATI SERIE 70TOP/70 SX CON PIANETTO

01877011 **EN** Head 2 sides S70TOP/S70 SX with shelf • **DE** Abschluss element seiten S70TOP/S70 SX mit ablage • **FR** Element de jonction 2 cotés S70TOP/S70 SX avec etagere • **ES** Embellecedor 2 lados S70TOP/S70 SX con estante
cm. 20x 161x 36h

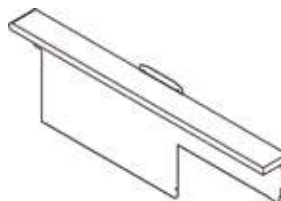

796,00
21.5 / 0,54

TESTATE 2 LATI S90 E 70

MOD. _____
COD. _____

DESCRIZIONE/DESCRIPTION/BEZEICHNUNG/DESCRIPTION/DESCRIPCIÓN
DIMENSIONI/DIMENSIONS/ABMESSUNGEN/DIMENSIONS/DIMENSIONES

POTENZA/POWER/LEISTUNG/PUISSANCE/POTENCIA
VOLTAGGIO/VOLTAGE/SPANNUNG/VOLTAGE/VOLTAJE

↓ kW kcal/h ↗ kW V~ Hz

PREZZO/PRICE
PREIS/PRIX/PRECIO
KG / M³



SB79TM-FDX TESTATA 2 LATI SERIE 70TOP/90 DX

01879000

EN Head 2 sides S70TOP/S90 DX • **DE** Abschluss element seiten S70TOP/S90 DX • **FR** Element de jonction 2 cotés S70TOP/S90 DX • **ES** Embellecedor 2 lados S70TOP/S90 DX
cm. 0,2x180,5x 90h

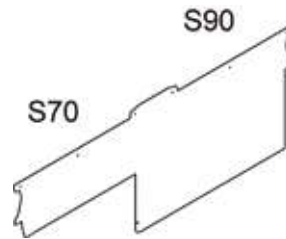

500,00
15.6 / 0,04

SB79TM-FPDX TESTATA 2 LATI SERIE 70TOP/90 DX CON PIANETTO

01879010

EN Head 2 sides S70TOP/S90 DX with shelf • **DE** Abschluss element seiten S70TOP/S90 DX mit ablage • **FR** Element de jonction 2 cotés S70TOP/S90 DX avec etagere • **ES** Embellecedor 2 lados S70TOP/S90 DX con estante
cm. 20x180,5x 90h

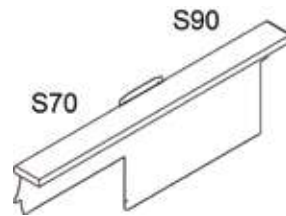

879,00
24.2 / 0,60

SB79TM-FSX TESTATA 2 LATI SERIE 70TOP/90 SX

01879001

EN Head 2 sides S70TOP/S90 SX • **DE** Abschluss element seiten S70TOP/S90 SX • **FR** Element de jonction 2 cotés S70TOP/S90 SX • **ES** Embellecedor 2 lados S70TOP/S90 SX
cm. 0,2x180,5x 90h

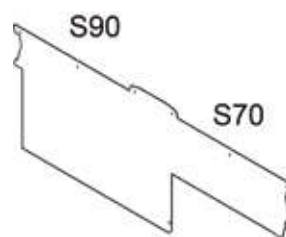

500,00
15.6 / 0,04

SB79TM-FPSX TESTATA 2 LATI SERIE 70TOP/90 SX CON PIANETTO

01879011

EN Head 2 sides S70TOP/S90 SX with shelf • **DE** Abschluss element seiten S70TOP/S90 SX mit ablage • **FR** Element de jonction 2 cotés S70TOP/S90 SX avec etagere • **ES** Embellecedor 2 lados S70TOP/S90 SX con estante
cm. 20x180,5x 90h

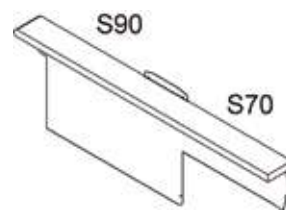

879,00
24.2 / 0,60

SB97TM-FDX TESTATA 2 LATI SERIE 90TOP/70 DX

01897000

EN Head 2 sides S90TOP/S70 DX • **DE** Abschluss element seiten S90TOP/S70 DX • **FR** Element de jonction 2 cotés S90TOP/S70 DX • **ES** Embellecedor 2 lados S90TOP/S70 DX
cm. 0,2x180,5x 90h

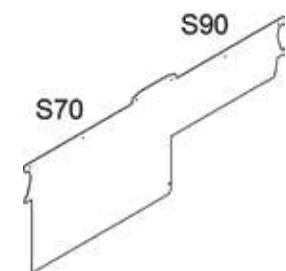

433,00
14.4 / 0,04

SB97TM-FPDX TESTATA 2 LATI SERIE 90TOP/70 DX CON PIANETTO

01897010

EN Head 2 sides S90TOP/S70 DX with shelf • **DE** Abschluss element seiten S90TOP/S70 DX mit ablage • **FR** Element de jonction 2 cotés S90TOP/S70 DX avec etagere • **ES** Embellecedor 2 lados S90TOP/S70 DX con estante
cm. 20x180,5x 90h

TESTATE 2 LATI S90 E 70

MOD. _____
COD. _____

DESCRIZIONE/DESCRIPTION/BEZEICHNUNG/DESCRIPTION/DESCRIPCIÓN
DIMENSIONI/DIMENSIONS/ABMESSUNGEN/DIMENSIONS/DIMENSIONES

POTENZA/POWER/LEISTUNG/PUISSANCE/POTENCIA
VOLTAGGIO/VOLTAGE/SPANNUNG/VOLTAGE/VOLTAJE

$\frac{kW}{kcal/h}$ $\frac{kW}{V \sim}$
Hz

PREZZO/PRICE
PREIS/PRIX/PRECIO
KG / M³



SB97TM-FSX TESTATA 2 LATI SERIE 90TOP/70 SX

01897001

EN Head 2 sides S90TOP/S70 SX • **DE** Abschluss element seiten S90TOP/S70 SX • **FR** Element de jonction 2 cotés S90TOP/S70 SX
• **ES** Embellecedor 2 lados S90TOP/S70 SX
cm. 0,2x180,5x 90h

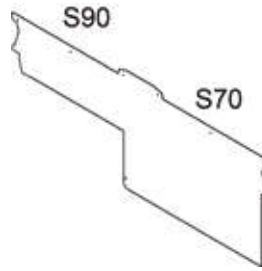

433,00
14.4 / 0,04

SB97TM-FPSX TESTATA 2 LATI SERIE 90TOP/70 SX CON PIANETTO

01897011

EN Head 2 sides S90TOP/S70 SX with shelf • **DE** Abschluss element seiten S90TOP/S70 SX mit ablage • **FR** Element de jonction 2 cotés S90TOP/S70 SX avec etagere • **ES** Embellecedor 2 lados S90TOP/S70 SX con estante
cm. 20x180,5x 90h

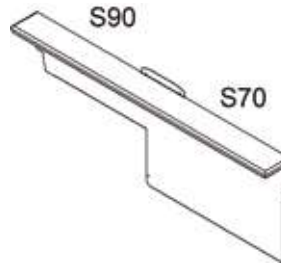

788,00
23 / 0,60



FMPG-20 + 40280600



FMPE-30



F1-G



FPE-25 + 40280800

FRIGGITRICI ELETTRICHE - TOP

MOD. _____
COD. _____

DESCRIZIONE/DESCRIPTION/BEZEICHNUNG/DESCRIPTION/DESCRIPCIÓN
DIMENSIONI/DIMENSIONS/ABMESSUNGEN/DIMENSIONS/DIMENSIONES

POTENZA/POWER/LEISTUNG/PUISSANCE/POTENCIA
VOLTAGGIO/VOLTAGE/SPANNUNG/VOLTAGE/VOLTAJE

⚡ kW _____
kcal/h _____
V~ _____
Hz _____

PREZZO/PRICE
PREIS/PRIX/PRECIO
KG / M³



FE-04EM
35010411

**FRIGGITRICE LT. 4 MONOFASE CESTINO CM. 13X23X10H -
PRODUZIONE PATATE 5 KG/H**

EN Fryer lts. 4 singlephase - Basket cm. 13x23x10h - Production 5 kg/hr • **DE** Friteuse lt. 4 einphasig - Korb cm. 13x23x10h - Pommes frites: 5 kg/h • **FR** Friteuse lt. 4 monophasé - Panier cm. 13x23x10h - Production de pommes frites 5 Kg/h • **ES** Freidoras 4 lt. monofásica - Cesta cm. 13x23x10h - Producción patatas 5 Kg/h
cm. 18x 42x 30h



⚡ 2,1 kW _____ **308,00**
230V~ _____ 9 / 0,04
50 Hz _____

FE-07EM
35010710

**FRIGGITRICE LT. 7 MONOFASE CESTINO CM. 21X23,5X10H -
PRODUZIONE PATATE 7 KG/H**

EN Fryer lts. 7 singlephase - Basket cm. 21x23,5x10h - Production 7 kg/hr • **DE** Friteuse lt. 7 einphasig - Korb cm. 21x23,5x10h - Pommes frites: 7 kg/h • **FR** Friteuse lt. 7 monophasé - Panier cm. 21x23,5x10h - Production de pommes frites 7 Kg/h • **ES** Freidoras 7 lt. monofásica - Cesta cm. 21x23,5x10h - Producción patatas 7 Kg/h
cm. 27x 42x 30h



⚡ 3 kW _____ **345,00**
230V~ _____ 9 / 0,05
50 Hz _____

FE-77EM
35020710

**FRIGGITRICE LT. 7+7 MONOFASE 2 CESTINI CM.
21X23,5X10H - PRODUZIONE PATATE 14 KG/H**

EN Fryer lts. 7+7 singlephase - 2 baskets cm. 21x23,5x10h - Production 14 kg/hr • **DE** Friteuse lt. 7+7 einphasig - 2 Korbe cm. 21x23,5x10h - Pommes frites: 14 kg/h • **FR** Friteuse lt. 7+7 monophasé - 2 Paniers cm. 21x23,5x10h - Production de pommes frites 14 Kg/h • **ES** Freidoras 7+7 lt. monofásica - 2 cestas cm. 21x23,5x10h - Producción patatas 14 Kg/h
cm. 54x 42x 30h



⚡ 6 kW _____ **641,00**
230V~ _____ 16 / 0,10
50 Hz _____

FEM-6
35010610

**FRIGGITRICE LT. 6 MONOFASE VASCA CM. 22X32,5X20H -
CESTINO CM. 20X27X11H - PRODUZIONE PATATE 7 KG/H**

EN Fryer lts. 6 singlephase - Tank cm. 22x32,5x20h - Basket cm. 20x27x11h - Production 7 kg/hr • **DE** Friteuse lt. 6 einphasig - Becken cm. 22x32,5x20h - Korb cm. 20x27x11h - Pommes frites 7 kg/h • **FR** Friteuse lt. 6 monophasé - Cuve cm. 22x32,5x20h - Panier cm. 20x27x11h - Production de pommes frites 7 Kg/h • **ES** Freidoras 6 lt. monofásica - Cuba cm. 22x32,5x20h - Cesta cm. 20x27x11h - Producción patatas 7 Kg/h
cm. 30x 51x 25h



⚡ 3 kW _____ **1.084,00**
230V~ _____ 13 / 0,08
50/60 Hz _____

FE-8
35010830

**FRIGGITRICE LT. 8 TRIFASE VASCA CM. 22X32,5X20H -
CESTINO CM. 20X27X11H - PRODUZIONE PATATE 9 KG/H**

EN Fryer lts. 8 threephase - Tank cm. 22x32,5x20h - Basket cm. 20x27x11h - Production 9 kg/hr • **DE** Friteuse lt. 8 dreiphasig - Becken cm. 22x32,5x20h - Korb cm. 20x27x11h - Pommes frites 9 kg/h • **FR** Friteuse lt. 8 triphase - Cuve cm. 22x32,5x20h - Panier cm. 20x27x11h - Production de pommes frites 9 Kg/h • **ES** Freidoras 8 lt. trifásica - Cuba cm. 22x32,5x20h - Cesta cm. 20x27x11h - Producción patatas 9 Kg/h
cm. 30x 51x 25h



⚡ 5,4 kW _____ **1.205,00**
400V~3N _____ 15 / 0,08
230V~3 _____
50/60 Hz _____

FE-10
35011030

**FRIGGITRICE LT. 10 TRIFASE VASCA CM. 29X32,5X20H -
CESTINO CM. 26X27X11H - PRODUZIONE PATATE 10 KG/H**

EN Fryer lts. 10 threephase - Tank cm. 29x32,5x20h - Basket cm. 26x27x11h - Production 10 kg/hr • **DE** Friteuse lt. 10 dreiphasig - Becken cm. 29x32,5x20h - Korb cm. 26x27x11h - Pommes frites 10 kg/h • **FR** Friteuse lt. 10 triphase - Cuve cm. 29x32,5x20h - Panier cm. 26x27x11h - Production de pommes frites 10 Kg/h • **ES** Freidoras 10 lt. trifásica - Cuba cm. 29x32,5x20h - Cesta cm. 26x27x11h - Producción patatas 10 Kg/h
cm. 40x 70x 25h



⚡ 6 kW _____ **1.402,00**
400V~3N _____ 21 / 0,22
230V~3 _____
50/60 Hz _____

FRIGGITRICI ELETTRICHE - TOP

MOD. _____
COD. _____

DESCRIZIONE/DESCRIPTION/BEZEICHNUNG/DESCRIPTION/DESCRIPCIÓN
DIMENSIONI/DIMENSIONS/ABMESSUNGEN/DIMENSIONS/DIMENSIONES

POTENZA/POWER/LEISTUNG/PUISSANCE/POTENCIA
VOLTAGGIO/VOLTAGE/SPANNUNG/VOLTAGE/VOLTAJE

⚡ kW kcal/h
⚡ kW V~ Hz

PREZZO/PRICE €
PREIS/PRIX/PRECIO €
KG / M³

FEM-2/6
35020610

FRIGGITRICE LT. 6+6 MONOFASE 2 VASCHE CM. 22X32,5X20H - 2 CESTI CM.20X27X11H - PRODUZIONE PATATE 14 KG/H

EN Fryer lts. 6+6 singlephase - 2 tanks cm. 22x32,5x20h - 2 baskets cm. 20x27x11h - Production 14 kg/hr • **DE** Friteuse lt. 6+6 einphasig - 2 Becke cm. 22x32,5x20h - 2 Korbe cm. 20x27x11h - Pommes frites 14 kg/h • **FR** Friteuse lt. 6+6 monophasé - 2 cuves cm. 22x32,5x20h - 2 Paniers cm. 20x27x11h - Production de pommes 14 Kg/h • **ES** Freidoras 6+6 lt. monofásica - 2 cubas cm. 22x32,5x20h - 2 cestas cm. 20x27x11h - Producción patatas 14 Kg/h
cm. 60x 51x 25h



⚡ 6 kW 2.028,00
230V~ 13 / 0,16
50/60 Hz

FE-2/8
35020830

FRIGGITRICE LT. 8+8 TRIFASE 2 VASCHE CM. 22X32,5X20H - 2 CESTI CM.20X27X11H - PRODUZIONE PATATE 18 KG/H

EN Fryer lts. 8+8 threephase - 2 tanks cm. 22x32,5x20h - 2 baskets cm. 20x27x11h - Production 18 kg/hr • **DE** Friteuse lt. 8+8 dreiphasig - 2 Becke cm. 22x32,5x20h - 2 Korbe cm. 20x27x11h - Pommes frites 18 kg/h • **FR** Friteuse lt. 8+8 triphasé - 2 cuves cm. 22x32,5x20h - 2 Paniers cm. 20x27x11h - Production de pommes 18 Kg/h • **ES** Freidoras 8+8 lt. trifásica - 2 cubas cm. 22x32,5x20h - 2 cestas cm. 20x27x11h - Producción patatas 18 Kg/h
cm. 60x 51x 25h

⚡ 10,8 kW 2.125,00
400V~3N 27 / 0,16
230V~3
50/60 Hz

FE-2/10
35021030

FRIGGITRICE LT. 10+10 TRIFASE 2 VASCHE CM. 29X32,5X20H - 2 CESTI CM.26X27X11H - PRODUZIONE PATATE 20 KG/H

EN Fryer lts. 10+10 threephase - 2 tanks cm. 29x32,5x20h - 2 baskets cm. 26x27x11h - Production 20 kg/hr • **DE** Friteuse lt. 10+10 dreiphasig - 2 Becke cm. 29x32,5x20h - 2 Korbe cm. 26x27x11h - Pommes frites 20 kg/h • **FR** Friteuse lt. 10+10 triphasé - 2 cuves cm. 29x32,5x20h - 2 Paniers cm. 26x27x11h - Production de pommes 20 Kg/h • **ES** Freidoras 10+10 lt. trifásica - 2 cubas cm. 29x32,5x20h - 2 cestas cm. 26x27x11h - Producción patatas 20 Kg/h
cm. 80x 70x 25h



⚡ 12 kW 2.437,00
400V~3N 38 / 0,42
230V~3
50/60 Hz

S-3
05210300

CAVALLETTO BASE

EN Stand • **DE** Untergestell • **FR** Piétement simple • **ES** Soporte base
cm. 30x 40x 55h

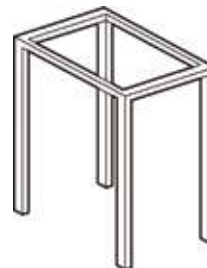

212,00
2 / 0,12

S-6
05210600

cm. 60x 40x 55h

233,00
3 / 0,22

R-3
05240300

RIPIANO

EN Shelf • **DE** Abstellbrett • **FR** Etagère • **ES** Estante
cm. 26x 39,5x 3h

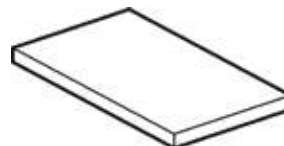

106,00
1 / 0,01

R-6
05240600

cm. 56x 39,5x 3h

132,00
2 / 0,01

S-40
40210400

CAVALLETTO CON RIPIANO

EN Stand with shelf • **DE** Untergestell offen mit boden • **FR** Support avec etagere • **ES** Soporte con estante
cm. 40x 58,5x 60h



529,00
20 / 0,18

S-80
40210800

cm. 80x 58,5x 60h



626,00
26 / 0,35

ACCESSORI FRIGGITRICI

MOD. _____
COD. _____

DESCRIZIONE/DESCRIPTION/BEZEICHNUNG/DESCRIPTION/DESCRIPCIÓN
DIMENSIONI/DIMENSIONS/ABMESSUNGEN/DIMENSIONS/DIMENSIONES

POTENZA/POWER/LEISTUNG/PUISSANCE/POTENCIA
VOLTAGGIO/VOLTAGE/SPANNUNG/VOLTAGE/VOLTAJE

⚡ kW _____
kcal/h _____
⚡ kW _____
V~ _____
Hz _____

PREZZO/PRICE € _____
PREIS/PRIX/PRECIO € _____
KG / M³

M-40
40220400

BASE A GIORNO
EN Open base unit • **DE** Untergestell offen • **FR** Base ouverte • **ES**
Base abierta
cm. 40x 58,5x 60h



434,00
14 / 0,18

MP-40
40220401

BASE CON PORTA
EN Stand with door • **DE** Unterbau mit Flügeltüren • **FR** Placard avec
porte • **ES** Base con puerta
cm. 40x 61,5x 60h



594,00
17 / 0,18

MC-40
40220420

**BASE CON 2 CASSETTI GN 1/1 CON 2 GN 1/1 H 15 IN
PLASTICA**
EN Stand with 2 drawers GN 1/1, with 2 plastic containers GN 1/1
h 15 • **DE** Unterbau mit 2 Schubladen GN 1/1 mit 2 GN 1/1 h 15
Kunststoffbehältern • **FR** Placard avec 2 tiroirs GN 1/1 avec 2 bacs GN
1/1 h 15 en plastique • **ES** Base con 2 cajones GN 1/1 con 2 GN 1/1
h 15 de plástico
cm. 40x 61,5x 60h



932,00
28 / 0,18

FME-10
35311030

**FRIGGITRICE CON MOBILE - LT. 10 TRIFASE VASCA CM.
29X32,5X18,5H - CESTINO CM.26X27X11H. BACINELLA
RACCOGLIOLIO CON FILTRO. PROD. PATATE: 10 KG/H**
EN Cabinet fryer Lt. 10 threephase Bowl cm. 29x32,5x18,5h - Basket cm.
26x27x11h. Drip tray with sieve. Production: 10 kg/h • **DE** Standfriteuse
lt. 10 dreiphasig Becken cm. 29x32,5x18,5h - Korb cm. 26x27x11h.
Fettauffangschale mit Sieb. Pommes frites: 10 kg/h • **FR** Friteuse sur
placard lt.10 triphase Cuve cm. 29x32,5x18,5h - Panier cm. 26x27x11h.
Collecteur d'huile avec filtre. Production de pommes frites: 10 kg/h • **ES**
Freidoras con mueble 10 lt. trifásica Cuba cm. 29x32,5x18,5h - Cesta
cm. 26x27x11h. Bandeja recoge aceite con filtro. Producción patatas: 10
Kg/h
cm. 40x 70x 85h



⚡ 6 kW _____ **1.816,00**
400V~3N _____ 35 / 0,36
230V~3 _____
50/60 Hz

FME-15
35311530

**FRIGGITRICE CON MOBILE - LT. 15 TRIFASE VASCA CM.
33X40X18,5H - CESTINO CM.30X33X12H. BACINELLA
RACCOGLIOLIO CON FILTRO. PROD. PATATE: 12 KG/H**
EN Cabinet fryer Lt. 15 threephase Bowl cm. 33x40x18,5h - Basket cm.
30x33x12h. Drip tray with sieve. Production: 12 kg/h • **DE** Standfriteuse
lt. 15 dreiphasig Becken cm. 33x40x18,5h - Korb cm. 30x33x12h.
Fettauffangschale mit Sieb. Pommes frites: 12 kg/h • **FR** Friteuse sur
placard lt.15 triphase Cuve cm. 33x40x18,5h - 2 Paniers cm. 30x33x12h.
Collecteur d'huile avec filtre. Production de pommes frites: 12 kg/h • **ES**
Freidoras con mueble 15 lt. trifásica Cuba cm. 33x40x18,5h - Cesta cm.
30x33x12h. Bandeja recoge aceite con filtro. Producción patatas: 12
Kg/h
cm. 40x 70x 85h

⚡ 9 kW _____ **2.119,00**
400V~3N _____ 42 / 0,36
50/60 Hz

FRIGGITRICI ELETTRICHE

MOD. _____
COD. _____

DESCRIZIONE/DESCRIPTION/BEZEICHNUNG/DESCRIPTION/DESCRIPCIÓN
DIMENSIONI/DIMENSIONS/ABMESSUNGEN/DIMENSIONS/DIMENSIONES

POTENZA/POWER/LEISTUNG/PUISSANCE/POTENCIA
VOLTAGGIO/VOLTAGE/SPANNUNG/VOLTAGE/VOLTAJE

⚡ kcal/h ⚡ kw
V~ Hz

PREZZO/PRICE
PREIS/PRIX/PRECIO
KG / M³



FME-2/10
35321030

FRIGGITRICE CON MOBILE - LT. 10+10 TRIFASE 2 VASCHE CM. 29X32,5X18,5H - 2 CESTI CM.26X27X11H. 2 BACINELLE RACCOGLIOLIO CON FILTRO. PRODUZIONE PATATE 20 KG/H
EN Cabinet fryer lt. 10+10 threephase 2 tanks cm. 29x32,5x18,5h - 2 baskets cm. 26x27x11h. 2 drip trays with sieves. Production 20 kg/hr
• **DE** Standfriteuse lt. 10+10 dreiphasig 2 Becke cm. 29x32,5x18,5h - 2 Korbe cm. 26x27x11h. 2 Fettauffangschalen mit Sieb. Pommes frites 20 kg/pro Stunde
• **FR** Friteuse sur placard lt.10+10 triphase 2 cuves cm. 29x32,5x18,5h - 2 Paniers cm. 26x27x11h. 2 bacs de récupération de l'huile avec filtre. Production de pommes 20 Kg/h
• **ES** Freidoras con mueble 10+10 lt. trifásica 2 cubas cm. 29x32,5x18,5h - 2 cestas cm. 26x27x11h. 2 bandejas recoge aceite con filtro. Producción patatas 20 Kg/h
cm. 80x 70x 85h



⚡ 12 kW
400V~3N
230V~3
50/60 Hz **3.110,00**
65 / 0,70

FME-2/15
35321530

FRIGGITRICE CON MOBILE - LT. 15+15 TRIFASE 2 VASCHE CM. 33X40X18,5H - 2 CESTI CM.30X33X12H. 2 BACINELLA RACCOGLIOLIO CON FILTRO. PRODUZIONE PATATE 24 KG/H
EN Cabinet fryer lt. 15+15 threephase 2 tanks cm. 33x40x18,5h - 2 baskets cm. 30x33x12h. 2 drip trays with sieves. Production 24 kg/hr
• **DE** Standfriteuse lt. 15+15 dreiphasig 2 Becke cm. 33x40x18,5h - 2 Korbe cm. 30x33x12h. 2 Fettauffangschalen mit Sieb. Pommes frites 24 kg/pro Stunde
• **FR** Friteuse sur placard lt.15+15 triphase 2 cuves cm. 33x40x18,5h - 2 Paniers cm. 30x33x12h. 2 bacs de récupération de l'huile avec filtre. Production de pommes 24 Kg/h
• **ES** Freidoras con mueble 15+15 lt. trifásica 2 cubas cm. 33x40x18,5h - 2 cestas cm. 30x33x12h. 2 bandejas recoge aceite con filtro. Producción patatas 24 Kg/h
cm. 80x 70x 85h

⚡ 18 kW
400V~3N
50/60 Hz **3.383,00**
75 / 0,70

531013500 CESTINO 1/2 PER FME-15

EN Basket 1/2 for FME-15 • **DE** Korb 1/2 für Friteuse FME-15 • **FR** Panier 1/2 pour FME-15 • **ES** Cesta 1/2 para FME-15
cm. 14x 33x 12h



71,00
0.8 / 0,04

531014400 CESTINO 1/2 PER FME-10

EN Basket 1/2 for FME-10 • **DE** Korb 1/2 für Friteuse FME-10 • **FR** Panier 1/2 pour FME-10 • **ES** Cesta 1/2 para FME-10
cm. 10x 25x 10h



52,00
0.6 / 0,03

FPE-20
35032030

FRIGGITRICE PASTICCERIA TRIFASE - 17 LITRI VASCA CM. 50X42,5X17,5H - 1 CESTO CM. 47X35X8H FILTRO E COPERCHIO VASCA
EN Confectioner's fryer threephase - 17 liters Tank cm. 50x42,5x17,5h - 1 basket cm. 47x35x8h Sieve and lid for tank
• **DE** Friteuse für Konditorei dreiphasig - 17 Liter Becken cm. 50x42,5x17,5h - 1 Korb cm. 47x35x8h Filter und Deckel für Becken
• **FR** Friteuse patisserie triphase - 17 litres Cuve cm. 50x42,5x17,5h - 1 panier cm. 47x35x8h Filtre et couvercle pour cuve
• **ES** Freidora repostería trifásica - 17 litros Cuba cm. 50x42,5x17,5h - 1 cesta cm. 47x35x8h Filtro y tapa cuba
cm. 60x 70x 25h



⚡ 6,6 kW
400V~3N
230V~3
50/60 Hz **1.760,00**
32 / 0,31

FRIGGITRICI PASTICCERIA ELETTRICHE - TOP

MOD. _____
COD. _____

DESCRIZIONE/DESCRIPTION/BEZEICHNUNG/DESCRIPTION/DESCRIPCIÓN
DIMENSIONI/DIMENSIONS/ABMESSUNGEN/DIMENSIONS/DIMENSIONES

POTENZA/POWER/LEISTUNG/PUISSANCE/POTENCIA
VOLTAGGIO/VOLTAGE/SPANNUNG/VOLTAGE/VOLTAJE

⚡ kW kcal/h
⚡ kW V~ Hz

PREZZO/PRICE
PREIS/PRIX/PRECIO
KG / M³



FPE-25
35032540

FRIGGITRICE PASTICCERIA TRIFASE - 24 LITRI VASCA CM. 70X42,5X17,5H - 1 CESTO CM. 67X35X8H FILTRO E COPERCHIO VASCA

EN Confectioner's fryer threephase - 24 liters Tank cm. 70x42,5x17,5h - 1 basket cm. 67x35x8h Sieve and lid for tank • **DE** Friteuse für Konditorei dreiphasig - 24 Liter Becken cm. 70x42,5x17,5h - 1 Korb cm. 67x35x8h Filter und Deckel für Becken • **FR** Friteuse patisserie triphase - 24 litres Cuve cm. 70x42,5x17,5h - 1 panier cm. 67x35x8h Filtre et couvercle pour cuve • **ES** Freidora repostería trifásica - 24 litros Cuba cm. 70x42,5x17,5h - 1 cesta cm. 67x35x8h Filtro y tapa cuba
cm. 80x 70x 25h



⚡ $\frac{10,2 \text{ kW}}{230V\sim 3}$ **2.222,00**
50/60 Hz 40 / 0,40

FPE-25
35032530

cm. 80x 70x 25h

⚡ $\frac{10,2 \text{ kW}}{400V\sim 3N}$ **2.222,00**
50/60 Hz 40 / 0,40

FPEH-25
35032531

FRIGGITRICE PASTICCERIA POTENZIATA TRIFASE - 24 LITRI VASCA CM. 70X42,5X17,5H - 1 CESTO CM. 67X35X8H FILTRO E COPERCHIO VASCA

EN Powerfull Confectioner's fryer threephase - 24 liters Tank cm. 70x42,5x17,5h - 1 basket cm. 67x35x8h Sieve and lid for tank • **DE** Friteuse leistungsfähiges für Konditorei dreiphasig - 24 Liter Becken cm. 70x42,5x17,5h - 1 Korb cm. 67x35x8h Filter und Deckel für Becken • **FR** Friteuse patisserie triphase plus puissants- 24 litres Cuve cm. 70x42,5x17,5h - 1 panier cm. 67x35x8h Filtre et couvercle pour cuve • **ES** Freidora repostería trifásica con mayor potencia - 24 litros Cuba cm. 70x42,5x17,5h - 1 cesta cm. 67x35x8h Filtro y tapa cuba
cm. 80x 70x 25h

⚡ $\frac{18 \text{ kW}}{400V\sim 3N}$ **2.415,00**
50/60 Hz 40 / 0,40

FPG-20
40032050

FRIGGITRICE PASTICCERIA GAS - 20 LITRI VASCA CM. 50X38X24H - 1 CESTO CM. 47X35X8H FILTRO E COPERCHIO VASCA

EN Gas confectioner's fryer - 20 liters Tank cm. 50x38x24h - 1 basket cm. 47x35x8h Sieve and lid for tank • **DE** Gasfriteuse für Konditorei - 20 Liter Becken cm. 50x38x24h - 1 Korb cm. 47x35x8h Filter und Deckel für Becken • **FR** Friteuse patisserie à gaz - 20 litres Cuve cm. 50x38x24h - 1 panier cm. 47x35x8h Filtre et couvercle pour cuve • **ES** Freidora repostería gas - 20 litros Cuba cm. 50x38x24h - 1 cesta cm. 47x35x8h Filtro y tapa cuba
cm. 60x 70x 25h

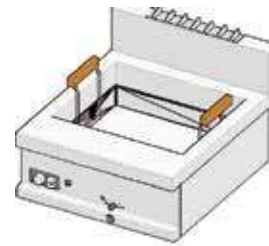

⚡ $\frac{11,2 \text{ kW}}{9.630 \text{ kcal/h}}$ **2.498,00**
43 / 0,31

FPG-30
40033050

FRIGGITRICE PASTICCERIA GAS - 28 LITRI VASCA CM. 70X38X24H - 1 CESTO CM. 67X35X8H FILTRO E COPERCHIO VASCA

EN Gas confectioner's fryer - 28 liters Tank cm. 70x38x24h - 1 basket cm. 67x35x8h Sieve and lid for tank • **DE** Gasfriteuse für Konditorei - 28 Liter Becken cm. 70x38x24h - 1 Korb cm. 67x35x8h Filter und Deckel für Becken • **FR** Friteuse patisserie à gaz - 28 litres Cuve cm. 70x38x24h - 1 panier cm. 67x35x8h Filtre et couvercle pour cuve • **ES** Freidora repostería gas - 28 litros Cuba cm. 70x38x24h - 1 cesta cm. 67x35x8h Filtro y tapa cuba
cm. 80x 70x 25h



⚡ $\frac{16,5 \text{ kW}}{14.190 \text{ kcal/h}}$ **2.891,00**
57 / 0,40

S-60
40210600

CAVALLETTO CON RIPIANO

EN Stand with shelf • **DE** Untergestell offen mit boden • **FR** Support avec etagere • **ES** Soporte con estante
cm. 60x 58,5x 60h



530,00
23 / 0,27

S-80
40210800

cm. 80x 58,5x 60h

626,00
26 / 0,35

ACCESSORI PASTICCERIA

MOD. _____
COD. _____

DESCRIZIONE/DESCRIPTION/BEZEICHNUNG/DESCRIPTION/DESCRIPCIÓN
DIMENSIONI/DIMENSIONS/ABMESSUNGEN/DIMENSIONS/DIMENSIONES

POTENZA/POWER/LEISTUNG/PUISSANCE/POTENCIA
VOLTAGGIO/VOLTAGE/SPANNUNG/VOLTAGE/VOLTAJE

⚡ kW kcal/h
⚡ kW V~ Hz

PREZZO/PRICE
PREIS/PRIX/PRECIO
KG / M³



M-60
40220600

BASE A GIORNO
EN Open base unit • **DE** Untergestell offen • **FR** Base ouverte • **ES** Base abierta
cm. **60x 58,5x 60h**



708,00
18 / 0,27

M-80
40220800

cm. **80x 58,5x 60h**

804,00
22 / 0,35

MP-60
40220602

BASE CON PORTE
EN Stand with doors • **DE** Unterbau mit Flügeltüren • **FR** Placard avec portes • **ES** Base con puertas
cm. **60x 61,5x 60h**



926,00
23 / 0,27

MP-80
40220802

cm. **80x 61,5x 60h**

1.036,00
28 / 0,35

MCP-80
40220821

BASE CON PORTA E CASSETTI 2 X GN 1/1 H 15 IN PLASTICA
EN Stand with door and drawers 2 plastic containers GN 1/1 h 15 • **DE** Unterbau mit Flügeltür und Schubladen 2 x GN 1/1 h 15 Kunststoffbehältern • **FR** Placard avec porte et tiroirs 2 bacs GN 1/1 h 15 en plastique • **ES** Base con puerta y cajones 2 x GN 1/1 h 15 de plástico
cm. **80x 61,5x 60h**



1.601,00
40 / 0,35

MC-80
40220820

BASE CON 2 CASSETTI GN 2/1 CON 4 GN 1/1 H 15 IN PLASTICA
EN Stand with 2 drawers GN 2/1, with 4 plastic containers GN 1/1 h 15 • **DE** Unterbau mit 2 Schubladen GN 2/1 mit 4 GN 1/1 h 15 Kunststoffbehältern • **FR** Placard avec 2 tiroirs GN 2/1 avec 4 bacs GN 1/1 h 15 en plastique • **ES** Base con 2 cajones GN 2/1 con 4 GN 1/1 h 15 de plástico
cm. **80x 61,5x 60h**



1.601,00
41 / 0,35

FMPE-20
35332030

FRIGGITRICE PASTICCERIA SU MOBILE TRIFASE - 17 LITRI
VASCA CM. 50X42,5X17,5H - 1 CESTO CM. 47X35X8H
FILTRO E COPERCHIO VASCA - BACINELLA RACCOGLIOLIO CON FILTRO

EN Confectioner's cabinet fryer threephase - 17 liters Tank cm. 50x42,5x17,5h - 1 basket cm. 47x35x8h Sieve and lid for tank. Drip tray with sieve • **DE** Friteuse für Konditorei mit Untergestell dreiphasig - 17 Liter Becken cm. 50x42,5x17,5h - 1 Korb cm. 47x35x8h Sieb und Deckel für Becken - Fettauffangschale mit Sieb • **FR** Friteuse patisserie sur placard triphase - 17 litres Cuve cm. 50x42,5x17,5h - 1 panier cm. 47x35x8h Filtre et couvercle pour cuve - Collecteur d'huile avec filtre • **ES** Freidora repostería en mueble trifásica - 17 litros Cuba cm. 50x42,5x17,5h - 1 cesta cm. 47x35x8h Filtro y tapa cuba - Bandeja recoge aceite con filtro
cm. **60x 70x 85h**



⚡ **6,6 kW**
400V~3N
230V~3
50/60 Hz

2.612,00
60 / 0,59

FRIGGITRICI PASTICCERIA ELETTRICHE

MOD. _____
COD. _____

DESCRIZIONE/DESCRIPTION/BEZEICHNUNG/DESCRIPTION/DESCRIPCIÓN
DIMENSIONI/DIMENSIONS/ABMESSUNGEN/DIMENSIONS/DIMENSIONES

POTENZA/POWER/LEISTUNG/PUISSANCE/POTENCIA
VOLTAGGIO/VOLTAGE/SPANNUNG/VOLTAGE/VOLTAJE

$\frac{kW}{kcal/h}$ $\frac{kW}{V}$
Hz

PREZZO/PRICE
PREIS/PRIX/PRECIO
KG / M³



FMPE-25
35332540

FRIGGITRICE PASTICCERIA TRIFASE - 24 LITRI VASCA CM. 70X42,5X17,5H - 1 CESTO CM. 67X35X8H FILTRO E COPERCHIO VASCA - BACINELLA RACCOGLIOLIO CON FILTRO
EN Confectioner's cabinet fryer threephase - 24 liters - Tank cm. 70x42,5x17,5h 1 basket cm. 67x35x8h - Sieve and lid for tank - Drip tray with sieve • **DE** Friteuse für Konditorei mit Untergestell dreiphasig - 24 Liter - Becken cm. 70x42,5x17,5h 1 Korb cm. 67x35x8h - Einlegesieb mit Deckel für Becken - Fettauffangschale mit Sieb • **FR** Friteuse patisserie triphase - 24 litres - Cuve cm. 70x42,5x17,5h. 1 panier cm. 67x35x8h Filtre et couvercle pour cuve - Collecteur d'huile avec filtre • **ES** Freidora repostaría trifásica - 24 litros - Cuba cm. 70x42,5x17,5h - 1 cesta cm. 67x35x8h Filtro y tapa cuba - Bandeja recoge aceite con filtro
cm. 80x 70x 85h



$\frac{10,2 kW}{230V\sim 3}$ **3.111,00**
 $\frac{72}{50/60 Hz}$ / 0,78

FMPE-25
35332530

cm. 80x 70x 85h

$\frac{10,2 kW}{400V\sim 3N}$ **3.111,00**
 $\frac{72}{50/60 Hz}$ / 0,78

FMPEH-25
35332531

FRIGGITRICE PASTICCERIA POTENZIATA - 24 LITRI VASCA CM. 70X42,5X17,5H - 1 CESTO CM. 67X35X8H FILTRO E COPERCHIO VASCA - BACINELLA RACCOGLIOLIO CON FILTRO
EN Powerfull Confectioner's cabinet fryer - 24 liters - Tank cm. 70x42,5x17,5h 1 basket cm. 67x35x8h - Sieve and lid for tank - Drip tray with sieve • **DE** Friteuse leistungsfähiges für Konditorei mit Untergestell - 24 Liter - Becken cm. 70x42,5x17,5h 1 Korb cm. 67x35x8h - Einlegesieb mit Deckel für Becken - Fettauffangschale mit Sieb • **FR** Friteuse patisserie plus puissants - 24 litres - Cuve cm. 70x42,5x17,5h. 1 panier cm. 67x35x8h Filtre et couvercle pour cuve - Collecteur d'huile avec filtre • **ES** Freidora repostaría con mayor potencia - 24 litros - Cuba cm. 70x42,5x17,5h - 1 cesta cm. 67x35x8h Filtro y tapa cuba - Bandeja recoge aceite con filtro
cm. 80x 70x 85h

$\frac{18 kW}{400V\sim 3N}$ **3.305,00**
 $\frac{72}{50/60 Hz}$ / 0,78

FMPE-30
35333030

FRIGGITRICE PASTICCERIA TRIFASE - 31 LITRI VASCA CM. 90X42,5X17,5H - 1 CESTO CM. 87X35X8H FILTRO E COPERCHIO VASCA - BACINELLA RACCOGLIOLIO CON FILTRO
EN Confectioner's cabinet fryer threephase - 31 liters - Tank cm. 90x42,5x17,5h 1 basket cm. 87x35x8h - Sieve and lid for tank - Drip tray with sieve • **DE** Friteuse für Konditorei mit Untergestell dreiphasig - 31 Liter - Becken cm. 90x42,5x17,5h 1 Korb cm. 87x35x8h - Einlegesieb mit Deckel für Becken - Fettauffangschale mit Sieb • **FR** Friteuse patisserie triphase - 31 litres - Cuve cm. 90x42,5x17,5h. 1 panier cm. 87x35x8h Filtre et couvercle pour cuve - Collecteur d'huile avec filtre • **ES** Freidora repostaría trifásica - 31 litros - Cuba cm. 90x42,5x17,5h - 1 cesta cm. 87x35x8h Filtro y tapa cuba - Bandeja recoge aceite con filtro
cm. 100x 70x 85h



$\frac{13,2 kW}{400V\sim 3N}$ **3.873,00**
 $\frac{83}{50/60 Hz}$ / 1,06

FMPG-20
40342050

FRIGGITRICE PASTICCERIA GAS - 20 LITRI VASCA CM. 50X38X24H - 1 CESTO CM. 47X35X8H FILTRO E COPERCHIO VASCA - BACINELLA RACCOGLIOLIO CON FILTRO
EN Confectioner's cabinet fryer gas - 20 liters Tank cm. 50x38x24h - 1 basket cm. 47x35x8h Sieve and lid for tank. Drip tray with sieve • **DE** Friteuse für Konditorei mit Untergestell gas - 20 Liter Becken cm. 50x38x24h - 1 Korb cm. 47x35x8h Sieb und Deckel für Becken - Fettauffangschale mit Sieb • **FR** Friteuse patisserie sur placard à gaz - 20 litres Cuve cm. 50x38x24h - 1 panier cm. 47x35x8h Filtre et couvercle pour cuve - Collecteur d'huile avec filtre • **ES** Freidora repostaría en mueble a gas - 20 litros Cuba cm. 50x38x24h - 1 cesta cm. 47x35x8h Filtro y tapa cuba - Bandeja recoge aceite con filtro
cm. 60x 70x 85h



$\frac{11,2 kW}{9.630 kcal/h}$ **3.525,00**
 $\frac{68}{50/60 Hz}$ / 0,78

FRIGGITRICI PASTICCERIA A GAS

MOD. _____
COD. _____

DESCRIZIONE/DESCRIPTION/BEZEICHNUNG/DESCRIPTION/DESCRIPCIÓN
DIMENSIONI/DIMENSIONS/ABMESSUNGEN/DIMENSIONS/DIMENSIONES

POTENZA/POWER/LEISTUNG/PUISSANCE/POTENCIA
VOLTAGGIO/VOLTAGE/SPANNUNG/VOLTAGE/VOLTAJE

$\frac{kW}{kcal/h}$ $\frac{kw}{V-Hz}$

PREZZO/PRICE
PREIS/PRIX/PRECIO
KG / M³



FMPG-30
40343050

FRIGGITRICE PASTICCERIA GAS - 28 LITRI VASCA CM. 70X38X24H - 1 CESTO CM. 67X35X8H - FILTRO E COPERCHIO VASCA - BACINELLA RACCOGLIOLIO CON FILTRO
EN Confectioner's cabinet fryer gas - 28 liters - Tank cm. 70x38x24h - 1 basket cm. 67x35x8h Sieve and lid for tank. Drip tray with sieve
• **DE** Friteuse für Konditorei mit Untergestell gas - 28 Liter - Becken cm. 70x38x24h - 1 Korb cm. 67x35x8h Sieb und Deckel für Becken - Fettauffangschale mit Sieb • **FR** Friteuse pâtisserie sur placard à gaz - 28 litres - Cuve cm. 70x38x24h - 1 panier cm. 67x35x8h Filtre et couvercle pour cuve - Collecteur d'huile avec filtre • **ES** Freidora repostería en mueble a gas - 28 litros - Cuba cm. 70x38x24h - 1 cesta cm. 67x35x8h Filtro y tapa cuba - Bandeja recoge aceite con filtro
cm. 80x 70x 85h



$\frac{16,5 kW}{14.190 kcal/h}$ **4.044,00**
84 / 1,06

40280600

SCIVOLO INOX 60
EN Stainless steel slide 60 • **DE** Rutsche aus Rostfreiem Stahl 60 • **FR** Goulotte en acier inox 60 • **ES** Deslizador inox 60
cm. 38x 55x 27h

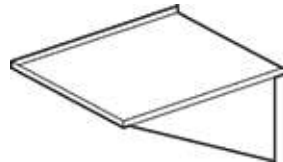

143,00
4 / 0,07

40280800

SCIVOLO INOX 80 / F45
EN Stainless steel slide 80 / F45 • **DE** Rutsche aus Rostfreiem Stahl 80 / F45 • **FR** Goulotte en acier inox 80 / F45 • **ES** Deslizador inox 80 / F45
cm. 38x 75x 27h

157,00
5 / 0,09

40281000

SCIVOLO INOX 100
EN Stainless steel slide 100 • **DE** Rutsche aus Rostfreiem Stahl 100 • **FR** Goulotte en acier inox 100 • **ES** Deslizador inox 100
cm. 38x 95x 27h

181,00
6 / 0,12

40290800

MITRA 800
EN Chimney jack 800 • **DE** Lüftungsaufsatz 800 • **FR** Mitre 800 • **ES** Caperuza 800

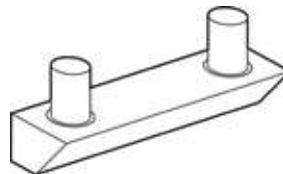

632,00
9 / 0,04

CA-11
40290110

CAMINO ANTIVENTO (OBBLIGATORIO PER FPG-30, FMPG-30, IN GERMANIA, OLANDA E AUSTRIA: MITRA PER ESTRAZIONE FORZATA FUMI COMBUSTI. MITRA + CAMINO ANTIVENTO PER ESTRAZIONE NATURALE FUMI COMBUSTI.)
EN Draught diverter (Obligatory for FPG-30, FMPG-30, in Germany, Holland and Austria: Chimney jack for forced extraction of burnt smoke. Chimney jack + draught diverter for natural extraction of burnt smoke.)
• **DE** Strömungssicherung (Pflicht für FPG-30, FMPG-30, in Deutschland, Holland e Österreich: Lüftungsaufsatz zur erzwungenen Wrasenabführung. Lüftungsaufsatz + Strömungssicherung zur natürlichen Wrasenabführung.)
• **FR** Cheminee anti-vent (Obligatoire pour FPG-30, FMPG-30 en Allemagne, Hollande et Autriche: Mitre pour sortie forcée des fumées brûlées. Mitre + cheminee anti-vent pour sortie naturelle des fumées brûlées.) • **ES** Chimenea contra viento (Obligatorio para FPG-30, FMPG-30 en Alemania, Holanda y Austria Caperuza para la extracción forzada de humos de combustión. Caperuza + chimenea contra viento para la extracción natural de humos de combustión.)
cm. Ø 11



300,00
5 / 0,01

FRIGGITRICI PASTICCERIA 45 LT

MOD. _____
COD. _____

DESCRIZIONE/DESCRIPTION/BEZEICHNUNG/DESCRIPTION/DESCRIPCIÓN
DIMENSIONI/DIMENSIONS/ABMESSUNGEN/DIMENSIONS/DIMENSIONES

POTENZA/POWER/LEISTUNG/PUISSANCE/POTENCIA
VOLTAGGIO/VOLTAGE/SPANNUNG/VOLTAGE/VOLTAJE

⚡ kW _____
kcal/h _____
V~ _____
Hz _____

PREZZO/PRICE
PREIS/PRIX/PRECIO
KG / M³



F45-78ET
08090835

FRIGGITRICE TRIFASE LT. 45 VASCA CM. 70X38X38H - 1 CESTO CM. 65X33X17H - FILTRO E COPERCHIO VASCA. BACINELLA RACCOGLIOLIO CON FILTRO. PRODUZIONE PATATE: 40 KG/H (INCLUSA 1 TESTATA CHIUSURA PIANO MOD.TPA-7)

EN Fryer threephase 45 lts - Bowl cm. 70x38x38h - 1 basket cm. 65x33x17h. Sieve and lid for pan. Drip tray with sieve. Production: 40 kg/h (included 1 Head end filler strip mod.TPA-7) • **DE** Friteuse dreiphasig lt. 45 - Becken cm. 70x38x38h - 1 Korb cm. 65x33x17h. Einlegesieb und Deckel für Becken. Fettauffangschale mit Sieb. Pommes frites: 40 kg/h (inbegriffen 1 Abschluss-Element mod.TPA-7) • **FR** Friteuse triphase lt. 45 - Cuve cm. 70x38x38h - 1 Panier cm. 65x33x17h. Filtre, couvercle pour cuve. Bac de récupération de l'huile avec filtre. Production de pommes frites: 40 kg/h (inclus 1 Élément de jonction top mod.TPA-7) • **ES** Freidoras trifásico 45 lt. - Cuba cm. 70x38x38h - 1 cesta cm. 65x33x17h. Filtro y tapa para cuba. Bandeja recoge aceite con filtro. Prod. patatas: 40 Kg/h (incluida 1 Chapa de cierre para top mod. TPA-7)

cm. 80x 70,5x 90h



⚡ 40 kW _____
400V~3N _____ **4.731,00**
50/60 Hz _____ 96 / 0,71

F45-78G
08260855

FRIGGITRICE GAS LT. 45 VASCA CM. 70X38X38H. - 1 CESTO CM. 65X33X17H. FILTRO E COPERCHIO VASCA. BACINELLA RACCOGLIOLIO CON FILTRO. PROD. PATATE: 40 KG/H (INCLUDE ENTRAMBE LE TESTATE CHIUSURA PIANO)

EN Gas Fryer 45 lts - Bowl cm. 70x38x38h - 1 basket cm. 65x33x17h. Sieve and lid for pan. Drip tray with sieve. Production: 40 kg/h (included both Heads end filler strip) • **DE** Gas-Friteuse lt. 45 - Becken cm. 70x38x38h - 1 Korb cm. 65x33x17h. Einlegesieb und Deckel für Becken. Fettauffangschale mit Sieb. Pommes frites: 40 kg/h (inbegriffen alle 2 Abschluss-Element) • **FR** Friteuse a gaz lt. 45 - Cuve cm. 70x38x38h - 1 Panier cm. 65x33x17h. Filtre, couvercle pour cuve. Bac de récupération de l'huile avec filtre. Production de pommes frites: 40 kg/h (inclus tous 2 Élément de jonction top) • **ES** Freidoras a gas 45 lt. - Cuba cm. 70x38x38h - 1 cesta cm. 65x33x17h. Filtro y tapa para cuba. Bandeja recoge aceite con filtro. Prod. patatas: 40 Kg/h (incluidas todas las 2 Chapa de cierre para top)

cm. 80x 70,5x 90h



⚡ 44 kW _____
37.840 kcal/h _____ **5.621,00**
110 / 1,07
⚡ 0,005 KW _____
230V~ _____
50 Hz _____

531033300 CESTO 1/1 F45

EN Basket 1/1 F45 • **DE** korb 1/1 F45 • **FR** Panier 1/1 F45 • **ES** Cesta 1/1 F45
cm. 65x 33x 17h



203,00
3 / 0,10

531041300 CESTO 1/2 F45

EN Basket 1/2 F45 • **DE** korb 1/2 F45 • **FR** Panier 1/2 F45 • **ES** Cesta 1/2 F45
cm. 28x 29x 15h



84,00
1.5 / 0,06

531047800 CESTO 1/3 F45

EN Basket 1/3 F45 • **DE** korb 1/3 F45 • **FR** Panier 1/3 F45 • **ES** Cesta 1/3 F45
cm. 21,5x 33x 16,5h



99,00
1.3 / 0,06

ACCESSORI PASTICCERIA

MOD.
COD.

DESCRIZIONE/DESCRIPTION/BEZEICHNUNG/DESCRIPTION/DESCRIPCIÓN
DIMENSIONI/DIMENSIONS/ABMESSUNGEN/DIMENSIONS/DIMENSIONES

POTENZA/POWER/LEISTUNG/PUISSANCE/POTENCIA
VOLTAGGIO/VOLTAGE/SPANNUNG/VOLTAGE/VOLTAJE

$\frac{kW}{kcal/h}$ $\frac{kW}{V \sim}$
Hz

PREZZO/PRICE
PREIS/PRIX/PRECIO
KG / M³



531017500 CESTINO 60
EN Basket 60 • DE Fritierkorb 60 • FR Panier 60 • ES Cesta 60
cm. 47x 35x 8h

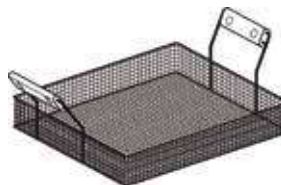

124,00
1.5 / 0,06

531016900 CESTINO 80
EN Basket 80 • DE Fritierkorb 80 • FR Panier 80 • ES Cesta 80
cm. 67x 35x 8h

129,00
2 / 0,08

531017700 CESTINO 100
EN Basket 100 • DE Fritierkorb 100 • FR Panier 100 • ES Cesta 100
cm. 87x 35x 8h

195,00
2.5 / 0,10

531036700 RETE CON MANIGLIA 60
EN grid with handle 60 • DE Raster mit Griff 60 • FR grille avec poignée 60 • ES grid con asa 60
cm. 43x 31x 22h



122,00
1 / 0,03

531036800 RETE CON MANIGLIA 80
EN grid with handle 80 • DE Raster mit Griff 80 • FR grille avec poignée 80 • ES grid con asa 80
cm. 63x 31x 22h

124,00
1.5 / 0,05

531036900 RETE CON MANIGLIA 100
EN grid with handle 100 • DE Raster mit Griff 100 • FR grille avec poignée 100 • ES grid con asa 100
cm. 83x 31x 22h

127,00
2 / 0,06

F-1G
20029500 **FORNELLONE A PAVIMENTO**
EN Gas stove • DE Gas-hocherkoeker 1 flamming • FR Rechaud a gaz
• ES Horno a pavimento
cm. 44x 57x 24h



$\frac{9,5 kW}{8.170 kcal/h}$ **557,00**
10 / 0,14

FB-1G
20029550 cm. 64x 76x 50h



$\frac{9,5 kW}{8.170 kcal/h}$ **741,00**
15 / 0,53

FO-1G
20029501 **FORNELLONE 1 FUOCO GAS**
EN Gas table-top stove - 1 burner • DE Gaskocher - 1 Kochstelle • FR
Rechaud a gaz, 1 feu • ES Horno 1 quemador gas
cm. 40x 60x 25h



$\frac{5,5 kW}{4.730 kcal/h}$ **824,00**
13 / 0,13

FO-2G
20029502 **FORNELLONE 2 FUOCHI GAS**
EN Gas table-top stove - 2 burners • DE Gaskocher, 2 Kochstellen
• FR Rechaud a gaz, 2 feux • ES Horno 2 quemadores gas
cm. 70x 60x 25h



$\frac{9 kW}{7.740 kcal/h}$ **1.295,00**
22 / 0,22

MOD.
COD.

DESCRIZIONE/DESCRIPTION/BEZEICHNUNG/DESCRIPTION/DESCRIPCIÓN
DIMENSIONI/DIMENSIONS/ABMESSUNGEN/DIMENSIONS/DIMENSIONES

POTENZA/POWER/LEISTUNG/PUISSANCE/POTENCIA
VOLTAGGIO/VOLTAGE/SPANNUNG/VOLTAGE/VOLTAJE

↓ kW kcal/h
↑ kw V~ Hz

PREZZO/PRICE
PREIS/PRIX/PRECIO
KG / M³



FO-3G
20029503

FORNELLONE 3 FUOCHI GAS
EN Gas table-top stove, 3 burners • **DE** Gaskocher, 3 Kochstellen • **FR** Rechaud a gaz, 3 feux • **ES** Horno 3 quemadores gas
cm. 105x 60x 25h

14,5 kW
12.470 kcal/h
1.810,00
35 / 0,32



KIT-FO-1FT
20029535

KIT GRIGLIA IN TONDINO 1 FUOCO PER FO-..
EN KIT grid rod 1 burner FO-.. • **DE** KIT Gitterstab 1 Brenner FO-..
• **FR** KIT tige grille 1 feux FO-.. • **ES** KIT red de varilla 1 quemador FO-..

154,00
3 / 0,01



CF-1
20029511

CAVALLETTO INOX PER FO/1G
EN Stainless steel stand for FO/1G • **DE** Untergestell für FO/1G • **FR** Support en acier inox pour FO/1G • **ES** Soporte inox para FO/1G
cm. 40x 50x 60h

475,00
17 / 0,18



CF-2
20029512

CAVALLETTO INOX PER FO/2G
EN Stainless steel stand for FO/2G • **DE** Untergestell für FO/2G • **FR** Support en acier inox pour FO/2G • **ES** Soporte inox para FO/2G
cm. 70x 50x 60h

626,00
23 / 0,35

CF-3
20029513

CAVALLETTO INOX PER FO/3G
EN Stainless steel stand for FO/3G • **DE** Untergestell für FO/3G • **FR** Support en acier inox pour FO/3G • **ES** Soporte inox para FO/3G
cm. 105x 50x 60h

713,00
29 / 0,43

AF-1
20029521

ARMADIETTO CON PORTE PER FO-1G
EN Cabinet with wing doors for FO/1G • **DE** Unterschrank mit Flügeltüren für FO/1G • **FR** Placard avec portes pour FO/1G • **ES** Pequeño armario con puertas para FO/1G
cm. 40x 53x 60h

696,00
27 / 0,18



AF-2
20029522

ARMADIETTO CON PORTE PER FO-2G
EN Cabinet with wing doors for FO/2G • **DE** Unterschrank mit Flügeltüren für FO/2G • **FR** Placard avec portes pour FO/2G • **ES** Pequeño armario con puertas para FO/2G
cm. 70x 53x 60h

1.013,00
33 / 0,35

AF-3
20029523

ARMADIETTO CON PORTE PER FO-3G
EN Cabinet with wing doors for FO/3G • **DE** Unterschrank mit Flügeltüren für FO/3G • **FR** Placard avec portes pour FO/3G • **ES** Pequeño armario con puertas para FO/3G
cm. 105x 53x 60h

1.545,00
39 / 0,43

PLFO
20029531

PIASTRA LISCIA FORNELLONE
EN Smooth griddle plate for gas stove • **DE** Fortkochplatte glatt für Gaskocher • **FR** Plaque lisse pour rechaud • **ES** Plancha lisa para horno
cm. 35x 37

228,00
10 / 0,02



PRFO
20029533

PIASTRA RIGATA FORNELLONE
EN Grooved griddle plate for gas stove • **DE** Fortkochplatte gerillt für Gaskocher • **FR** Plaque rainurée para rechaud • **ES** Plancha estriada para horno
cm. 35x 37

271,00
10 / 0,02



MOD. _____
COD. _____

DESCRIZIONE/DESCRIPTION/BEZEICHNUNG/DESCRIPTION/DESCRIPCIÓN
DIMENSIONI/DIMENSIONS/ABMESSUNGEN/DIMENSIONS/DIMENSIONES

POTENZA/POWER/LEISTUNG/PUISSANCE/POTENCIA
VOLTAGGIO/VOLTAGE/SPANNUNG/VOLTAGE/VOLTAGE

$\frac{kW}{kcal/h}$ $\frac{kw}{V\sim}$
Hz

PREZZO/PRICE
PREIS/PRIX/PRECIO
KG / M³



544439900 ANELLO PER WOK

EN Wok ring • **DE** Wok Aufsatzring • **FR** Anneau Wok • **ES** Anillo Wok
cm. Ø 22,5x 3,5h



157,00
2 / 0,00



Graphit Group

www.graphitgroup.com

Yverdon-les-Bains (Suisse)

Varese (Italia)

Swalmen (Netherlands)